

BRIDGE
COLLECTION



reddot design award
winner 2018



Silver
Delta Awards '18
▲



archiproducts
DESIGN AWARDS
WINNER 2018

Font
BARCELONA

DESIGN SWITCHES & SOCKETS

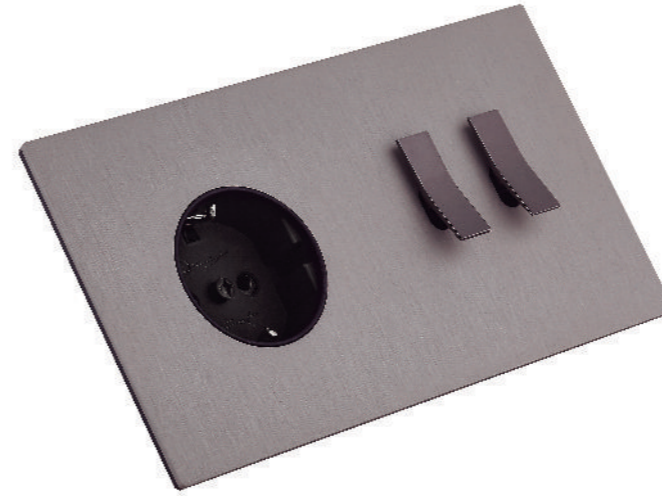

ACABADOS DE PLACA
PLATE FINISHES
FINITIONS DES PLAQUES



ALUMINIO
PLATA CEPILLADO
MATE

BRUSHED MATT
SILVER
ALUMINIUM

ALUMINIUM
ARGENTE BROSSE
MAT



ALUMINIO
NEGRO
CEPILLADO MATE

BRUSHED
MATT BLACK

ALUMINIUM NOIR
BROSSE MAT



ACERO
INOXIDABLE
CEPILLADO

BRUSHED
STAINLESS
STEEL

ACIER INOX
BROSSE



LATÓN
DORADO
SATINADO MATE

SATIN MATT
GOLDEN BRASS

LAITON DORE
SATINE MAT



LATÓN
GRAFITO
CEPILLADO

BRUSHED
GRAPHITE
BRASS

LAITON
GRAPHITE
BROSSE



LATÓN
PATINÉ
AMERICANO

ANTIQUE
BRONZE
BRASS

LAITON
PATINE
AMERICAIN



CORIAN
BLANCO *

WHITE
CORIAN *

CORIAN *
BLANC

ACABADOS DE MANECILLA
TOGGLE FINISHES
FINITIONS DES LEVIERS



CROMADO
SEMI-MATE

SEMI-MATT
CROME
PLATED

CHROME
SEMI-MAT



CROMADO

CHROME
PLATED

CHROME



DORADO
BRILLANTE

BRIGHT
GOLDEN

DORE
BRILLANT



NÍQUEL
NEGRO

BLACK NICKEL
PLATED

NICKEL
NOIR



NÍQUEL
SEMI-MATE

SEMI MATT
NICKEL
PLATED

NICKEL
SEMI-MATE



PATINÉ
AMERICANO

ANTIQUE
BRONZE

PATINE
AMERICAIN

Consultar más acabados en Aluminio Pintado. Acero inox y Latón.
Ask for our new finishes in Painted Aluminium, Stainless Steel and Brass.
Nous consulter pour d'autres finitions en Aluminium peint, en Acier inox et en Laiton.

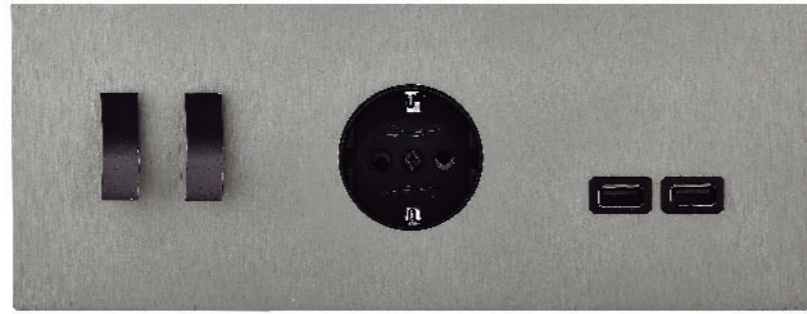

ACABADOS DE MARCO
FRAME FINISHES
FINITIONS DES ENCADREMENTS



CROMADO SEMIMATE, SEMI-MATT CHROME-PLATED, CHROME SEMI MATE

CROMADO, CHROME-PLATED, CHROME

DORADO BRILLANTE, BRIGHT GOLDEN, DORE BRILLANT

NÍQUEL, NICKEL PLATED, NIQUEL

LATÓN PATINÉ AMERICANO, ANTIQUE BRONZE BRASS, PATINE AMERICAIN

NÍQUEL NEGRO, BLACK NICKEL, NICKEL NOIR

ACABADOS DE BOTÓN DE PULSADOR Y REGULADOR
DIMMER & PUSHBUTTON FINISHES
FINITIONS DES BOUTONS POUSSOIRS ET VARIATEURS



REGULADOR

PULSADOR

DIMMER

PUSHBUTTON

VARIATEUR

BOUTON
POUSSOIR

INTERIOR, INTERIOR, INTERIEUR



ACERO
INOXIDABLE
CEPILLADO

ALUMINIO
NEGRO
CEPILLADO
MATE

ALUMINIO
PLATA
CEPILLADO
MATE

LATÓN
DORADO
SATINADO
MATE

LATÓN
PATINÉ
AMERICANO

GRAFITO
CEPILLADO

BRUSHED
STAINLESS
STEEL

BRUSHED
MATT
BLACK
ALUMINIUM

BRUSHED
MATT
SILVER
ALUMINIUM

SATIN
MATT
GOLDEN
BRASS

ANTIQUE
BRONZE
BRASS

GRAFITO
CEPILLADO

ACIER
INOX
BROSSE

ALUMINIUM
NOIR
BROSSE
MAT

ALUMINIUM
ARGENTE
BROSSE
MAT

LAITON
DORE
SATINE
MAT

PATINE
AMERICAIN

GRAFITO
CEPILLADO

EXTERIOR, EXTERIOR, EXTERIEUR



CROMADO
SEMI
MATE

CROMADO

DORADO
BRILLANTE

NÍQUEL

LATÓN
PATINÉ
AMERICANO

NÍQUEL
NEGRO

SEMI-MATT
CHROME
PLATED

CHROME
PLATED

GOLDEN
BRIGHT

NICKEL
PLATED

ANTIQUE
BRONZE
BRASS

BLACK
NICKEL

CHROME
SEMI
MATE

CHROME

DORE
BRILLANT

NICKEL

PATINE
AMERICAIN

NICKEL
NOIR

Consultar más acabados en Aluminio Pintado, Acero inox y Latón.
Ask for our new finishes in Painted Aluminium, Stainless Steel and Brass.
Nous consulter pour d'autres finitions en Aluminium peint, en Acier inox et en Laiton.

PERSONALIZACIÓN, CUSTOMIZATION, PERSONNALISATION

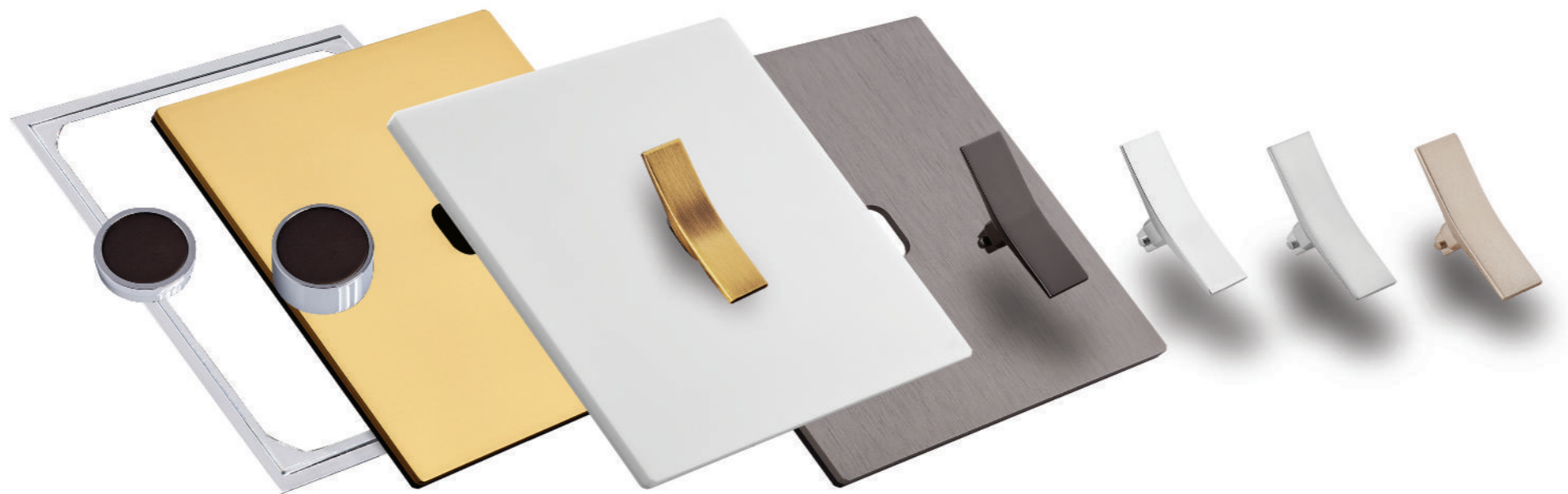

COMPATIBILIDAD CAJAS ELÉCTRICAS

Bridge se adapta a cajas universales, chinas y británicas.

Por favor indíquenos en el momento de hacer el pedido en qué caja instalará el producto.

ELECTRICAL BOXES COMPATIBILITY

Bridge is available for universal, chinese and british flush mounted boxes.

Please once you place the order indicate us the kind of boxes where mechanisms will be installed.

COMPATIBILITE DES BOITIERS D'ENCASTREMENT

La Collection Bridge s'adapte aux boitiers universels, chinois ou britanniques. Merci de bien vouloir nous indiquer le type de boitier lors du passage de commande.

ENCHUFE SOCKET PRISE

SCHUKO	FRANCÉS FRENCH FRANCAISE	BRITÁNICO BRITISH BRITANNIQUE 13A s/BS1363-2	BRITÁNICO BRITISH BRITANNIQUE 5A s/BS546	CHINO CHINESE CHINOISE	UNIVERSAL UNIVERSAL UNIVERSEL
--------	--------------------------------	---	---	------------------------------	-------------------------------------



FORMATOS DE PLACA-CAJA UNIVERSAL

UNIVERSAL BOX PLATES SIZES

FORMATS DES PLAQUES BOITIERS UNIVERSELS

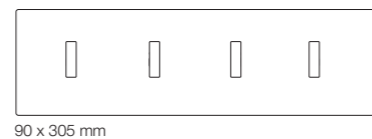
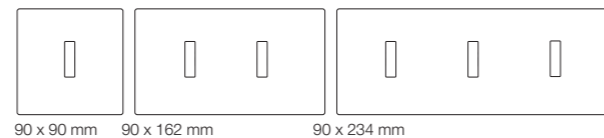

FORMATOS DE PLACA-CAJA BRITÁNICA

BRITISH STANDARD PLATES SIZES

FORMATS DES PLAQUES BOITIERS BRITANNIQUES

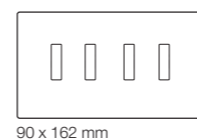
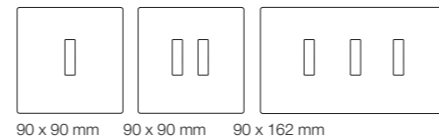

UNIVERSAL
UNIVERSAL
UNIVERSEL
60X60X40 mm



BRITÁNICO
BRITISH
BRITANNIQUE
75x75x35 mm

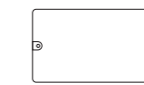

BRITÁNICO
BRITISH
BRITANNIQUE
75x135x35mm

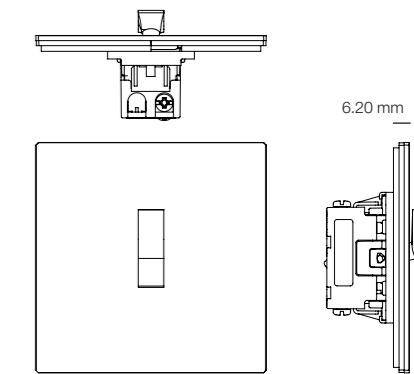

BRIDGE
COLLECTION



DESIGN SWITCHES & SOCKETS

| info@fontbarcelona.com | TEL_(+34) 935 743 330 |
| www.FONTBARCELONA.com |