



**EGLO**  
my light | my style



**2022/23**

**OUTDOOR LUMINAIRES**

AUSSENLEUCHTEN  
LUMINAIRES EXTÉRIEURS





Dear valued customers and business partners, and loyal EGLO friends,

We offer the perfect lighting for your garden, terrace or balcony. Our selection of exterior lights ranges from classic models to modern, minimalist, and even extravagant designs. We have also embraced the outdoor living trend and created an extensive garden living range.

Exterior lights are not only aesthetically appealing – they provide essential security for your home too, particularly during dark autumn evenings and winter months. The lights in our Safety & Comfort range, all of which feature motion sensors, are ideal for this purpose.

Our connect.z smart light system makes operating your lighting system easy and convenient from your mobile or by remote control. We offer a range of products that allows you to stay connected even in the garden.

In response to the current demand for sustainability, energy conservation and responsible use of resources, we have also expanded our selection of exterior lights to include our first high-illumination solar models.

We hope you enjoy browsing our catalogue!

Geschätzte Kunden und Geschäftspartner, treue EGLO-Freunde,

Wir bieten Ihnen die perfekte Beleuchtung für Ihren Garten, Ihre Terrasse oder Ihren Balkon. Unser Sortiment an Außenleuchten reicht von klassischen Modellen bis hin zu modernen, minimalistischen und auch extravaganen Designs. Zudem haben wir die Trends „Wohnen im Außenbereich“ aufgegriffen und ein umfangreiches Garden Living Sortiment erstellt.

Außenleuchten sind aber nicht nur aus ästhetischen Gründen sinnvoll, sondern sorgen vor allem in den dunklen Herbsttagen und Wintermonaten für die nötige Sicherheit rund um Ihr Zuhause. Das gelingt mit unseren Leuchten aus dem Bereich Safety & Comfort, welche alle über Bewegungssensoren verfügen.

Unser Smart Light System connect.z ermöglicht Ihnen die bequeme Bedienung Ihres Lichtsystems. Von Ihrem Mobiltelefon aus oder per Fernbedienung. Hier bieten wir eine Produktrange die Konnektivität bis in den Garten bietet.

Auf die Trends Nachhaltigkeit, Energiesparen und dem verantwortungsvollen Umgang mit Ressourcen, haben wir auch in unserem Außenleuchten Sortiment reagiert. Hier haben wir erste Solarmodelle mit hoher Lichtleistung in unserem Sortiment ergänzt.

Wir wünschen Ihnen viel Vergnügen beim Durchstöbern unseres Katalogs!

Chers clients, chers partenaires, chers amis d'EGLO,

EGLO vous propose des solutions d'éclairage parfaites pour votre jardin, votre terrasse ou votre balcon. Notre gamme de luminaires d'extérieur va du classique au moderne, en passant par le minimaliste et l'extravagant. Par ailleurs, en nous appuyant sur le concept « Vivre à l'extérieur », nous avons créé toute une gamme Garden Living.

En plus d'être esthétiques, les luminaires extérieurs assurent également la sécurité dont vous avez besoin autour de votre maison, surtout pendant les sombres journées d'automne et les mois d'hiver. C'est le cas de nos luminaires de la gamme Safety & Comfort, qui disposent tous de capteurs de mouvement.

Notre système Smart Light Bluetooth connect.z vous permet de commander facilement votre système d'éclairage à partir de votre téléphone portable ou d'une télécommande.

Nous vous souhaitons beaucoup de plaisir à parcourir notre catalogue !





## CONTENT

INHALT  
CONTENU

**4**



### High IP Class

Hohe IP Klasse  
Classe IP élevée

**8**



### Safety & Comfort

Sicherheit und Komfort  
Sécurité & confort

**14**



### EGLO connect.z

EGLO connect.z  
EGLO connect.z

**34**



### Modern

Modern  
Moderne

**120**



### Classic

Klassik  
Classique

**170**



### Spots, Recessed & Accessories

Spots, Einbauleuchten & Zubehör  
Spots, luminaires encastrés & accessoires

**204**



### Garden Living

Garten Leben  
Vie au jardin

**222**



### Solar

Solar  
Solar

**230**



### Legend & Register

Legende und Register  
Légende & registre

# Best protection against wind and weather

Bester Schutz vor Wind und Wetter  
Meilleure protection contre le vent et les intempéries



EGLO's High IP class product range includes all luminaires with a particularly high degree of protection. These are best suited for harsh environments such as sandy or coastal regions.

All EGLO outdoor lights are basically secured with at least a degree of protection of IP44! For higher degrees, the degree of protection is indicated in the info box of the lights.

EGLOs High IP class Produktsortiment umfasst alle Leuchten mit einem besonders hohen Schutzgrad. Diese sind bestens geeignet für raue Umgebungen wie beispielsweise sandige oder küstennahe Regionen.

Alle EGLO Außenleuchten sind grundsätzlich mit mindestens einem Schutzgrad von IP44 gesichert! Bei höheren Graden wird der Schutzgrad im Infokasten der Leuchten angegeben.

La gamme de produits EGLO de classe IP élevée comprend tous les luminaires présentant un degré de protection particulièrement élevé. Ils sont parfaitement adaptés aux environnements difficiles tels que les régions sablonneuses ou côtières.

Toutes les lampes d'extérieur EGLO sont toujours protégées avec un degré de protection d'au moins IP44 ! Pour les degrés supérieurs, le degré de protection est indiqué dans la boîte d'information des feux.

## SOLIDS / FESTSTOFFE / SOLIDES

<b>0</b>	<p>Non protected. Nicht geschützt. Non protégé.</p>
<b>1</b>	<p>Protected against a solid object greater than 50mm, such as a hand. Geschützt gegen feste Gegenstände, die größer als 50 mm sind, wie z. B. eine Hand. Protégé contre un objet solide de plus de 50 mm, comme une main.</p>
<b>2</b>	<p>Protected against a solid object greater than 12mm, such as a finger. Geschützt gegen feste Gegenstände, die größer als 12 mm sind, wie z. B. einen Finger. Protégé contre un objet solide de plus de 12 mm, tel qu'un doigt.</p>
<b>3</b>	<p>Protected against a solid object greater than 2,5mm, such as a screw driver. Geschützt gegen feste Gegenstände, die größer als 2,5 mm sind, z. B. einen Schraubendreher. Protégé contre un objet solide supérieur à 2,5 mm, tel qu'un tournevis.</p>
<b>4</b>	<p>Protected against a solid object greater than 1mm, such as a screw or wire. Geschützt gegen feste Gegenstände, die größer als 1 mm sind, wie z. B. Schrauben oder Drähte. Protégé contre un objet solide de plus de 1 mm, tel qu'une vis ou un fil.</p>
<b>5</b>	<p>Dust protected. Prevents ingress of dust sufficient to cause harm. Staubgeschützt. Verhindert das Eindringen von Staub, der ausreicht, um Schäden zu verursachen. Protégé contre la poussière. Empêche la pénétration de poussière suffisamment pour causer des dommages.</p>
<b>6</b>	<p>Dust tight. No ingress of dust. Staubdicht. Kein Eindringen von Staub. Étanche à la poussière. Pas de pénétration de poussière.</p>

## WATER / WASSER / L'EAU

<b>0</b>	<p>Non protected. Nicht geschützt. Non protégé.</p>
<b>1</b>	<p>Protected against vertical dripping water. Limited liquid entry. Geschützt gegen senkrechtes Tropfwasser. Eingeschränkter Flüssigkeitseintrag. Protégé contre les gouttes d'eau verticales. Entrée de liquide limitée.</p>
<b>2</b>	<p>Protected against vertical dripping water when tiled up 15°. Limited liquid entry. Geschützt gegen senkrechtes Tropfwasser bei Verfliesung 15°. Eingeschränkter Flüssigkeitseintrag. Protégé contre les gouttes d'eau verticales lorsqu'il est carrelé jusqu'à 15°. Entrée de liquide limitée.</p>
<b>3</b>	<p>Protected against vertical spraying water at an angle up to 68°. Limited liquid entry. Geschützt gegen senkrechtes Spritzwasser in einem Winkel bis 68°. Eingeschränkter Flüssigkeitseintrag. Protégé contre les projections d'eau verticales à un angle allant jusqu'à 68°. Entrée de liquide limitée.</p>
<b>4</b>	<p>Protected against vertical splashing water at an angle up to 60°. Limited liquid entry. Geschützt gegen senkrechtes Spritzwasser in einem Winkel bis 60°. Eingeschränkter Flüssigkeitseintrag. Protégé contre les projections d'eau verticales à un angle allant jusqu'à 60°. Entrée de liquide limitée.</p>
<b>5</b>	<p>Protected against jets of water from all directions. Limited liquid entry. Geschützt gegen Strahlwasser aus allen Richtungen. Eingeschränkter Flüssigkeitseintrag. Protégé contre les jets d'eau de toutes directions. Entrée de liquide limitée.</p>
<b>6</b>	<p>Protected against powerful jets of water from all directions. Limited liquid entry. Geschützt gegen starke Wasserstrahlen aus allen Richtungen. Eingeschränkter Flüssigkeitseintrag. Protégé contre les jets d'eau puissants de toutes les directions. Entrée de liquide limitée.</p>
<b>7</b>	<p>Protected against the effects of water immersion between 15cm and 1m. Geschützt gegen die Auswirkungen von Wassereintauchen zwischen 15 cm und 1 m. Protégé contre les effets d'une immersion dans l'eau entre 15cm et 1m.</p>
<b>8</b>	<p>Protected against the effects of water immersion under pressure beyond 1m. Geschützt gegen die Auswirkungen des Eintauchens in Wasser unter Druck über 1 m. Protégé contre les effets de l'immersion dans l'eau sous pression au-delà de 1m.</p>

# IP65

For more detailed information see DIN EN 60529.  
Für genauere Informationen siehe DIN EN 60529.  
Pour des informations plus détaillées, voir DIN EN 60529.

# HIGH IP CLASS

Chapter / Kapitel / Chapitre **connect.z**



IP65

NEMA-Z

27



IP55

EREMITANA-Z

27



IP65

MONTEROLO-Z

30-31

Chapter / Kapitel / Chapitre **Modern**



IP54

RIFORANO

38



IP54

NEMBRO

40



IP55

DONINNI 1

42



IP65

DONINNI 1

42-43



IP65

MELZO

46



IP54

STAGNONE

53



IP65

HELSINKI

56-57



IP55

HELSINKI

56



IP64

RUBIO

60



IP64

SORRONARO

61



IP54

FORNACI

70



IP54

KIBEA

73



IP55

FANDINA

76



IP55

SERRICELLA

76



IP55

TAPARITA

79



IP65

SALITTA

79



IP55

SPIAZZINA

84



IP54

RIGA-LED

90



IP55

EREMITANA

100



IP65

SPONGANO

102



IP65

MARUGGIO

103



IP54

CALPINO 2

104



IP54

CALPINO

104



IP55

DESELLA 1

105



IP54

CAMARDA

106-107



IP54

CHINOVA

109



## Chapter / Kapitel / Chapitre Classic



CHIAPPERA

125

IP65



CASCINETTA

132-133

IP54



RAVELLO

136-137

IP54



SELINUS

137

IP65



CANOVE

146

IP55

## Chapter / Kapitel / Chapitre Spots, Recessed & Accessories



NEMA

175

IP54



SPINETOLI

175

IP65



FAEDO 4

176

IP65



FAEDO 3

178-179, 182-183

IP65



LAMEDO

190

IP 65/67



RIGA 3

190

IP67



TRONTO

191

IP 65/67



SALITTA

192

IP65



ARACENA

193

IP65



ZIMBA-LED

194

IP65



MARGO

196

IP 65/67



CONNECTOR BOX

201

IP68

## Chapter / Kapitel / Chapitre Garden Living



MANNERA

206-207

IP54



FOSSOMBRONE

208

IP65



BOTTONA

210

IP65



MONTEROLO

212-213

IP65



SPINETOLI 2

219

IP65

## Chapter / Kapitel / Chapitre Solar



LAMOZZO

226

IP54



This product is available in different colors and shapes. / Dieser Artikel ist in unterschiedlichen Farben und Formen verfügbar.  
Cet article est disponible en différentes couleurs et formes.

# SAFETY & COMFORT





# SAFETY & COMFORT



## Light at the right time

Light activated by movements offers many advantages. EGLO sensor luminaires and sensors provide you with a great deal of comfort in your daily life and increase the safety of your own four walls.

## Licht zum richtigen Zeitpunkt

Licht, das durch Bewegungen aktiviert wird, bietet Ihnen viele Vorteile. Mit den Sensorleuchten und Sensoren von EGLO bringen Sie erheblichen Komfort in Ihren Alltag und erhöhen die Sicherheit rund um Ihr Zuhause.

## Lumière au bon moment

Lumière, qui est activé par le mouvement, offre de nombreux avantages. Avec les lumières des capteurs et des capteurs de EGLO apporter un confort considérable dans votre vie quotidienne et d'augmenter la sécurité de vos propres quatre murs.



**1. COMFORT**



**2. SAFETY**



**3. SECURITY**



**4. SAVE MONEY**

**1. COMFORT**

The light comes on – without requiring you to push a button, leaving your hands free to carry your shopping bags. Come home comfortably with the sensors and sensor lamps by EGLO.

**2. SAFETY**

EGLO sensors and sensor lamps will show you thresholds and tripping hazards in time. Lower your accident risk in and around your home.

**3. SECURITY**

Motion detection will safely light up badly visible areas when this is necessary. You will always be able to see what is happening and can deter unbidden guests with the EGLO sensors and sensor lamps.

**4. SAVE MONEY**

Sensors and sensor lamps by EGLO help you save money. Your light will only come on when it is needed, and lower the energy costs for every home.

**1. KOMFORT**

Das Licht geht an – ohne dass Sie einen Schalter drücken müssen und Sie haben die Hände frei, um die Einkäufe zu tragen. Kommen Sie komfortabel nach Hause mit den Sensoren und Sensorleuchten von EGLO.

**2. SICHERHEIT**

EGLO Sensoren und Sensorleuchten lassen Sie Schwellen und Stolperfallen vorzeitig erkennen. Senken Sie dadurch das Unfallrisiko in und um Ihr Zuhause.

**3. SCHUTZ**

Durch die Erfassung von Bewegung können schlecht einsichtbare Bereiche beleuchtet werden, wenn es notwendig ist. Sehen Sie immer was passiert und schrecken Sie ungebetene Gäste mit EGLO Sensoren und Sensorleuchten ab.

**4. GELD SPAREN**

Sensoren und Sensorleuchten von EGLO helfen Ihnen bares Geld zu sparen. Das Licht geht nur an, wenn es benötigt wird und senkt damit die Energiekosten in Ihrem Zuhause.

**1. COMFORT**

La lumière s’allume – sans que vous n’ayez besoin de presser un interrupteur et vous avez les mains libres pour porter les achats. Entrez confortablement chez vous avec les capteurs et les luminaires à capteurs d’EGLO.

**2. SÛRETÉ**

Les capteurs et les luminaires à capteurs d’EGLO vous permettent de détecter d’avance les seuils et sources de trébuchement. Réduisez ainsi les risques d’accident dans et autour de votre foyer.

**3. SÉCURITÉ**

Il est possible grâce à la saisie des mouvements d’éclairer au besoin des zones difficiles à voir. Ayez toujours un œil sur ce qu’il se passe et découragez les intrus avec les capteurs et les lampes à capteur d’EGLO.

**4. DE L’ARGENT EN SÉCURITÉ**

Les capteurs et les lampes à capteur d’EGLO vous aident à économiser de l’argent comptant. La lumière ne vient que lorsque celle-ci est requise, ce qui réduit ainsi les dépenses énergétiques de tout foyer.

# SAFETY & COMFORT

Chapter / Kapitel / Chapitre **connect.z**



**CONNECT-Z SENSOR**  
24

Chapter / Kapitel / Chapitre **Modern**



**RIFORANO**  
39



**PALOSCO**  
45



**FIUMICINO**  
48



**CALDIERO**  
52



**HELSENKI**  
56-57



**RUBIO**  
60



**SORRONARO**  
61



**MADRIZ**  
62



**CASAZZA**  
62-63



**SALVANESCO**  
69



**FORNACI**  
70



**CORNALE**  
72



**AZZINANO**  
74



**PERNATE**  
80



**TRONO STICK**  
87



**RIGA 5**  
92-93



**ATOLLARI**  
96



**SESIMBA 1**  
98



**SAKEDA**  
105



**MUSSOTTO**  
110



**VERRES**  
110



**BREGANZO 1**  
113



**TRIBANO**  
113



**CERNO**  
114-115



**CITY**  
116-117



**BELCREDA**  
118

## Chapter / Kapitel / Chapitre Classic



**ALAMONTE 3**  
128



**RAVELLO**  
136



**SIDNEY**  
139



**LISIO**  
140



**NAVEDO**  
158,160



**LATERNA 4**  
165



**LATERNA 5**  
166

## Chapter / Kapitel / Chapitre Spots, Recessed & Accessories



**PAGINO**  
172



**FAEDO 3**  
180-181,184-185



**DETECT ME 1**  
186,189



**DETECT ME 3**  
186,189



**DETECT ME 6**  
186,189



**DETECT ME 5**  
187



**LM\_LED\_E27**  
198

## Chapter / Kapitel / Chapitre Solar



**CORBEZZOLA**  
224-225



**BARACCONI**  
224



**MARTANO**  
225



**LAMOZZO**  
226



**LAMOZZO 1**  
226



**PORRASSA**  
227



**UTERA**  
227



**VILLAGRAPPA**  
228



**CASABAS**  
228



**PALIZZI**  
229



**PASTION**  
229



This product is available in different colors and shapes. / Dieser Artikel ist in unterschiedlichen Farben und Formen verfügbar.  
Cet article est disponible en différentes couleurs et formes.

# connect.2





# Discover the smart world



## connect.z combines two control technologies in one system

connect.z vereint zwei Steuerungstechnologien in einem System

connect.z réunit deux technologies de commande au sein d'un même système



ZigBee is far and away the most widely used standard in the smart home world.

ZigBee ist der am weitesten verbreitete Standard in der Smart Home Welt.

ZigBee est le protocole le plus répandu au monde dans le domaine du Smart Home.

### ADVANTAGES :

- › Mesh network
- › Direct connection with Amazon Echo and Google Home
- › Compatible with products from different manufacturers
- › High level of security
- › Easy setup
- › Energy efficient

### VORTEILE:

- › Mesh-Netzwerk
- › Direkte Verbindung mit Amazon Echo und Google Home
- › Herstellerübergreifend kompatibel
- › Hohe Sicherheit
- › Einfache Einrichtung
- › Energieeffizient

### AVANTAGES:

- › Réseau maillé
- › Connexion directe à Amazon Echo et Google Home
- › Compatible indépendamment du fabricant
- › Sécurité élevée
- › Installation facile
- › Économe en énergie

# connect.2



Bluetooth is an established standard in the digital world.  
Bluetooth ist ein etablierter Standard in der digitalen Welt.  
Bluetooth est un standard de communication reconnu dans le monde numérique.

#### ADVANTAGES:

- › Local & secure network
- › Protocol is mainly audio (low debit)
- › Easy setup
- › Usable offline
- › Energy efficient

#### VORTEILE:

- › Lokales & sicheres Netzwerk Protokoll hauptsächlich Audio (Low Debit)
- › Einfache Einrichtung
- › Offline nutzbar
- › Energieeffizient

#### AVANTAGES:

- › Réseau local et sûr
- › Protocole essentiellement audio (bas débit)
- › Installation facile
- › Utilisable hors-ligne
- › Économe en énergie

# Light up your world!

Bringen Sie Licht in Ihren Alltag!  
Illuminez votre quotidien !



connect.z offers a wide range of lamps and lighting equipment. Select products from the following options according to your needs:  
connect.z bietet ein großes Sortiment an Leuchten und Leuchtmitteln. Wählen Sie die Produkte ganz nach Ihren Bedürfnissen aus folgenden Varianten:  
connect.z propose une large gamme de luminaires et d'ampoules. Sélectionnez les produits en fonction de vos besoins parmi les variantes suivantes :

**Warm White**

**Neutral White**

**Tunable White**

Individual light from 50,000 white tones.  
Individuelles Licht aus 50.000 Weißtönen.  
Luminaire individuel à 50 000 tons de blanc.

**TW + RGB Colors**

Diverse lighting selection from 50,000 white tones and 16 million colours.  
Vielseitige Lichtauswahl aus 50.000 Weißtönen und 16 Mio. Farben.  
Sélection étendue de luminaires à 50 000 tons de blanc et 16 millions de couleurs.

Enjoy relaxing moments!  
Genießen Sie entspannte Momente!  
Profitez de moments de détente !

Stay focussed & efficient!  
Bleiben Sie konzentriert & leistungsfähig!  
Restez concentré(e) et performant(e) !

Stay focussed & efficient!  
Bleiben Sie konzentriert & leistungsfähig!  
Restez concentré(e) et performant(e) !

Create the perfect atmosphere!  
Kreieren Sie Ihr perfektes Ambiente!  
Créez votre ambiance parfaite !



## Enjoy many useful convenience features:

Es erwarten Sie viele nützliche Komfortfunktionen:  
De nombreuses fonctionnalités utiles vous attendent pour votre confort :



### TIMERS AND CALENDARS / TIMER UND ZEITPLÄNE/ MINUTERIE ET CALENDRIER

Make your daily life easier with timers and calendars.  
Wake up relaxed with the simulated sunrise.

Unterstützen Sie Ihren Alltag mit Timern und Zeitplänen. Entwickeln Sie eigene Lichtroutinen und machen Sie Ihr Leben leichter.

Facilitez-vous la vie à l'aide de la fonction minuterie et calendrier.  
Réveillez-vous en douceur grâce au simulateur de lever de soleil.

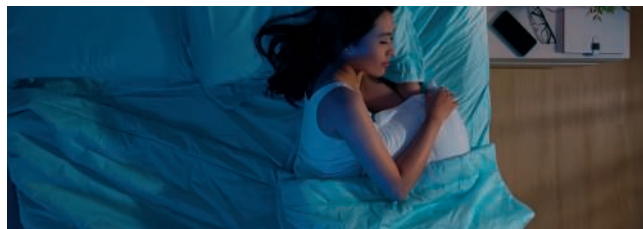

### LIGHT ALARM CLOCK/ LICHTWECKER/ REVEIL LUMINEUX

You'd rather not start your day in a bad mood? Wake up relaxed with the simulated sunrise.

Keine Lust mit schlechter Laune in den Tag zu starten? Entspannt aufwachen mit dem simulierten Sonnenaufgang.

Pas envie de commencer la journée de mauvaise humeur ? Réveillez-vous en douceur grâce au simulateur de lever de soleil.



### DISCO FUNCTION/MODE/ DISCOFUNKTION/MODUS/ FONCTION/MODE DISCO

For the perfect party mood, the disco function synchronises the light to the beat of your favourite songs.

Für die perfekte Partystimmung schaltet die Discofunktion das Licht passend zum Beat Ihres Lieblingsongs.

Pour une ambiance festive parfaite, la fonction disco enclenche le luminaire au rythme de votre chanson préférée.



### PRESENCE SIMULATOR/ ANWESENHEITSSIMULATION/ SIMULATEUR DE PRESENCE

Protect your home with the convenient presence simulator. Variable time intervals allow the system to turn the lights on and off to simulate your presence at home and deter unwanted guests.

Schütze Sie Ihr Zuhause mit der komfortablen Anwesenheitssimulation. Dank variabler Zeitintervalle simuliert das System durch Ein- und Ausschalten der Beleuchtung die Anwesenheit im Haus und schreckt so ungebetene Gäste ab.

Protégez votre domicile à l'aide du très pratique simulateur de présence. Le système simule votre présence en allumant et en éteignant les lumières à intervalles variables et décourage ainsi les invités indésirables.



### VOICE COMMANDS/ SPRACHSTEUERUNG/COMMANDE VOCALE

More convenient! Turn the light on whenever you want with only a voice command.

Noch komfortabler! Mit nur einem Sprachbefehl schaltet sich das Licht nach Ihren Wünschen an und aus.

C'est encore plus confortable ! Allumez votre luminaire comme vous le souhaitez d'une simple commande vocale.

## Control options

Steuerungsmöglichkeiten  
Possibilités de commande



Set your smart home as you prefer! With the app, voice commands, or remote control.

Steuern Sie Ihr Smart Home wie Sie es möchten! Via App, Sprachsteuerung oder mit der Fernbedienung.

Commandez votre Smart Home comme vous le souhaitez ! Via l'appli, la commande vocale ou la télécommande.

### APP CONTROL



Use the free app for smartphone, tablet, or smartwatch.

Nutzen Sie die kostenlose App für das Smartphone, Tablet oder die Smartwatch.

Utilisez l'appli gratuite sur votre smartphone, votre tablette ou votre montre connectée.

### VOICE COMMANDS



Use intelligent voice assistants such as Google Home and Amazon Alexa.

Nutzen Sie intelligente Sprachassistenten wie Google Home und Amazon Alexa.

Utilisez des assistants vocaux intelligents comme Google Home ou Amazon Alexa.

### REMOTE CONTROL



Use the practical remote connect.z operation at any time.

Nutzen Sie auch jederzeit die praktische connect.z Fernbedienung.

Vous pouvez aussi utiliser à tout moment la télécommande connect.z.

### CONNECT.Z ACCESSORIES



Use clever accessories such as the movement sensor and much more.

Nutzen Sie cleveres Zubehör wie z.B. den Bewegungssensor uvm.

Utilisez des accessoires malins tels que le capteur de mouvement et bien d'autres encore.

### DIMMER FUNCTION



Use the practical dimmer function via app, speech command or remote control.

Nutzen Sie die praktische Dimmfunktion via App, Sprachbefehl oder Fernbedienung.

Utilisez la fonction de gradation via l'appli, la commande vocale ou la télécommande.

# One system, many possibilities!

Ein System – viele Möglichkeiten!

Un système, de nombreuses possibilités!



No matter how you start, you can integrate new products into your connect.z system at any time and gradually expand your smart home.  
Egal wie Sie starten, Sie können jederzeit neue Produkte in Ihr connect.z System integrieren und Ihr smartes Zuhause nach und nach erweitern.  
Quel que soit votre choix, vous pouvez à tout moment intégrer de nouveaux produits à votre système connect.z et améliorer progressivement votre maison intelligente.



All you need to start is a connect.z product and the remote control. No internet connection is required and you have access to:

Sie benötigen zum Start lediglich ein connect.z Produkt und die Fernbedienung. Es wird kein Internetzugang benötigt und Sie haben Zugriff auf:

Pour démarrer, il vous suffit d'un produit connect.z et de la télécommande. Aucune connexion Internet n'est nécessaire. Vous avez accès aux :

#### Standard functions: Standardfunktionen: Fonctionnalités standard :

- › Select colour/ Farbauswahl/ sélection de couleur
- › Change colour/ Farbwechsel/ changement de couleur
- › Dim/ Dimmen/ gradation
- › Favourites (2x)/ Favoriten (2x)/ favoris (2x)
- › Groups (3x)/ Gruppen (3x)/ groupes (3x)
- › Candle mode/ Kerzenmodus/ mode bougie

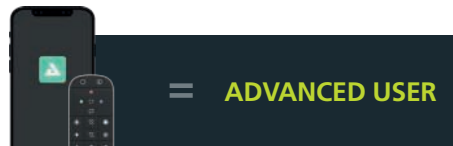

Besides the standard functions, would you also like access to the practical convenience features? Then you need only your smartphone or tablet and the Awox app. This app allows you to control your lights via Bluetooth®.

Sie möchten zu den Standardfunktionen auch noch Zugriff auf die praktischen Komfortfunktionen haben? Dann benötigen Sie nur Ihr Smartphone oder Tablet und die Awox App. Mit der App haben Sie die Möglichkeit, Ihre Leuchten über Bluetooth® zu steuern.

Outre les options standard, vous souhaitez également pouvoir utiliser les fonctionnalités de confort les plus pratiques ? Pour cela, vous avez seulement besoin de votre smartphone ou de votre tablette et de l'appli Awox. L'appli vous permet de commander vos luminaires via Bluetooth®.

#### Standard functions + convenience features/ Standardfunktionen + Komfortfunktionen / Fonctionnalités standard + confort

- › Light alarm clock/ Lichtwecker/ réveil lumineux
- › Presence simulation/ Anwesenheitssimulation/ simulateur de présence
- › Disco function/ Discofunktion/ fonction disco
- › Timers & timetables /Timer & Zeitpläne/ minuteur et calendrier
- › Accessories can be incorporated/ Einbindung von Zubehör möglich/ connexion d'accessoires possible



Use the system's full potential and control your smart home through the Awox app using WIFI or Bluetooth® as well as integrating a voice assistant into the system. This gives you:

Nutzen Sie das volle Potenzial des Systems und steuern Sie Ihr Smart Home über die Awox App mithilfe von WLAN oder Bluetooth® und integrieren Sie zusätzlich noch einen Sprachassistenten in das System. So mit erhalten Sie:

Exploitez tout le potentiel du système en commandant votre Smart Home grâce à l'appli Awox via le réseau Wi-Fi ou Bluetooth®, et intégrez également un assistant vocal au système. Vous obtenez ainsi :

#### Standard functions + convenience features + voice commands\*

#### Standardfunktionen + Komfortfunktionen + Sprachsteuerung\*

#### Fonctionnalités standard + confort + commande vocale\*

- › Amazon Alexa or Google Home/ Amazon Alexa oder Google Home/ Amazon Alexa ou Google Home

- \* Use a voice assistant with integrated bridge.
- \* Nutzen Sie einen Sprachassistenten mit integrierter Bridge.
- \* Utilisez un assistant vocal avec Bridge intégré.

## You already have connect-c luminaires from the previous system! What now?

Sie besitzen bereits connect-c Leuchten des Vorgängersystems! Was nun?  
Vous disposez déjà de luminaires connect-c de l'ancien système! Que faire ?

No problem! The previous connect-c products are compatible with the new connect.z system.  
Kein Problem! Die bisherigen connect-c Produkte sind mit dem neuen connect.z System kompatibel.  
Aucun problème! Les anciens produits connect-c sont compatibles avec le nouveau système connect.z.

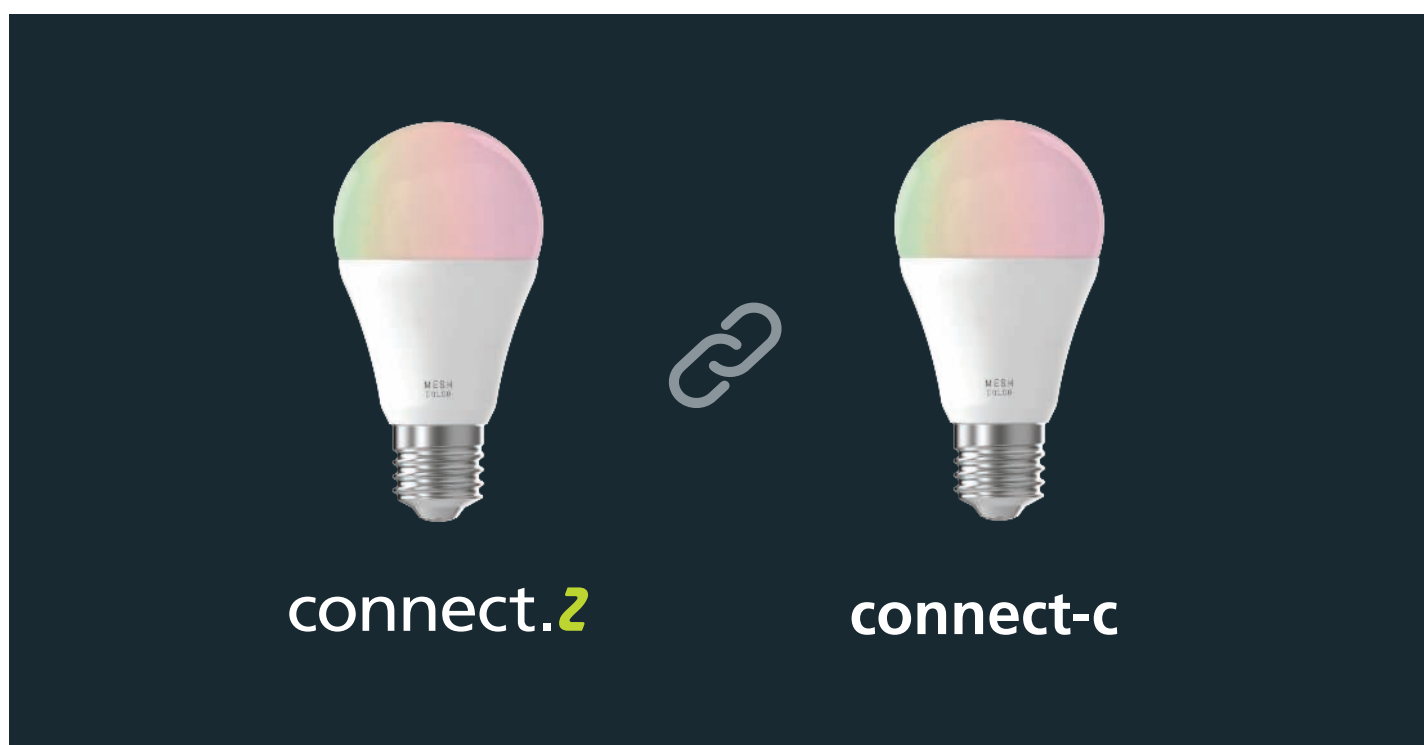

### EGLO connect-c - connect.z

The existing EGLO connect-c system is compatible with the new EGLO connect.z system. You don't need to switch from the existing Bluetooth low energy system to the new open protocol ZigBee 3.0. Lights from EGLO connect-c can be incorporated into the existing EGLO connect.z system.

### EGLO connect-c - connect.z

Das bestehende EGLO connect-c System ist mit dem neuen EGLO connect.z System kompatibel. Sie müssen nicht von dem bestehendem Bluetooth low energy System auf das neue offene Protokoll ZigBee 3.0 umsteigen. Leuchten von EGLO connect-c können in das bestehende EGLO connect.z System eingebunden werden.

### EGLO connect-c - connect.z

Le système EGLO connect-c existant est compatible avec le nouveau système EGLO connect.z. Vous n'avez pas besoin de passer du système Bluetooth à basse consommation existant au nouveau protocole ouvert ZigBee 3.0. Les luminaires EGLO connect-c peuvent être intégrés au système EGLO connect.z existant.



# OVERVIEW

## EGLO CONNECT.Z



CONNECT Z  
24



CONNECT-Z  
SENSOR  
24



ARGOLIS-Z  
26



NEMA-Z  
27



EREMITANA-Z  
27



BASALGO-Z  
27



NISIA-Z  
28



MONTEROLO-Z  
30-31



E27-LED-A60  
32



GU10-LED  
32



This product is available in different colors and shapes. / Dieser Artikel ist in unterschiedlichen Farben und Formen verfügbar.  
Cet article est disponible en différentes couleurs et formes.

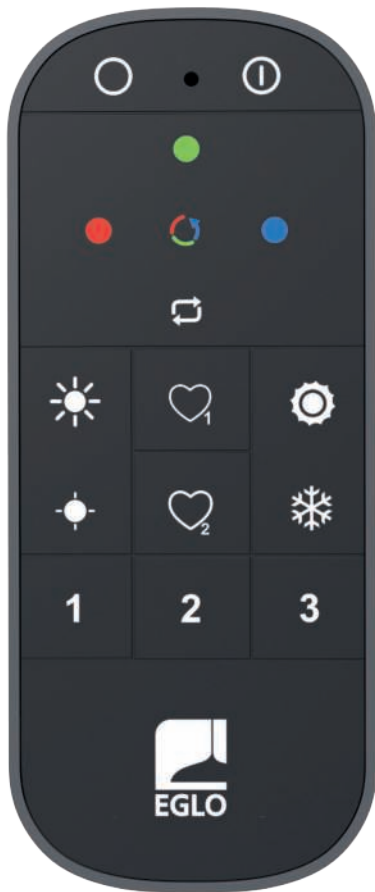

99099



99106



120°, 12 m  
20 sec. - 10 min.

**SAFETY & COMFORT**

### 99099 CONNECT Z

remote control; plastic, grey  
Fernbedienung; Kunststoff, grau  
Télécommande; plastique, gris

L 122, B 54, H 18



ACCU  
AAA,  
R03P



1,5V



9 002759 990992



### 99106 CONNECT-Z SENSOR

accessory; plastic, white  
Zubehör; Kunststoff, weiss  
Accessoires; plastique, blanc

L 75, H 75, A 70



ACCU  
AA,  
LR6 HP



2900mA,  
1,5V



IP44



9 002759 991067

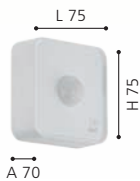



## ADVANTAGES OF THE CONNECT-Z SENSOR

### IP44 Safety no cabling necessary

The CONNECT-Z SENSOR is battery-operated, so that no difficult cabling is necessary. The sensor can be mounted directly on the wall. With the mounting bracket (included in the delivery), you can easily adjust the detection range to your needs. This permits fine adjustment by 30 degrees to the left and right.

### Night mode

Night mode When Night mode is enabled the luminaires receive the indication night or day from the CONNECT-Z SENSOR. Choose from 3 sensitivity settings (25 to 75%).

### Night movement detection

When Night movement detection is enabled the CONNECT-Z SENSOR turns on the luminaires with the chosen light intensity when movement is detected. You can choose from 3 movement detection sensitivity settings. The light will turn off after the selected time when no movement is detected.

### Combination of Night mode and Night movement detection

## VORTEILE DES CONNECT-Z SENSOR

### IP44 Schutz Keine Verkabelung notwendig

Der CONNECT-Z SENSOR ist batteriebetrieben, so dass keine schwierige Verkabelung erforderlich ist. Der Sensor kann direkt an die Wand montiert werden. Mit der Montagehalterung (im Lieferumfang enthalten) können Sie den Erfassungsbereich ganz einfach an Ihre Bedürfnisse anpassen. Dadurch ist eine Feinjustierung von 30 Grad nach links und rechts möglich.

### Nachtmodus

Wenn der Nachtmodus aktiviert ist, erhalten die Leuchten die Anzeige Nacht oder Tag vom CONNECT-Z SENSOR. Wählen Sie aus 3 Empfindlichkeitseinstellungen (25 bis 75%).

### Nachtbewegungserkennung

Wenn die Nachtbewegungserkennung aktiviert ist, schaltet der CONNECT-Z SENSOR die Leuchten mit der gewählten Lichtintensität ein, wenn die Bewegung erkannt wird. Sie können aus 3 Bewegungserkennungseinstellungen wählen. Das Licht schaltet sich nach der gewählten Zeit aus, wenn keine Bewegung erkannt wird.

### Kombination von Night mode und Night movement detection

## ADVANTAGES DE LA CAPTEUR CONNECT-Z SENSOR

### Protection IP44 Aucun câble nécessaire

Le CONNECT-Z SENSOR est alimenté par batterie, donc aucun câblage difficile n'est nécessaire. Avec le support de montage (inclus dans la livraison), vous pouvez facilement ajuster l'étendue de la détection à vos besoins. Ce réglage fin de 30 degrés à gauche et à droite est possible.

### Mode de nuit (Night mode)

Lorsque le mode de nuit est activé, les luminaires reçoivent l'indication du jour ou de la nuit du capteur CONNECT-Z SENSOR. Choisissez parmi 3 réglages de sensibilité (de 25 à 75%).

### Détection de mouvement nocturne

Lorsque la détection de mouvement nocturne est activée, le CONNECT-Z SENSOR allume les luminaires avec l'intensité lumineuse choisie lorsqu'un mouvement est détecté. Vous pouvez choisir parmi 3 réglages de sensibilité de détection de mouvement. Si aucun mouvement n'est détecté, la lumière s'éteindra après la période sélectionnée.

### Combinaison du mode de nuit et de la détection de mouvement nocturne



900124

LED



900125

LED



900126

LED

### 900124 ARGOLIS-Z

surface-mounted light; aluminium, black / plastic, white  
 Aufbauleuchte; Alu, schwarz / Kunststoff, weiss  
 luminaire en saillie; aluminium, noir / plastique, blanc

L 285, B 285, H 30



19,5W 2700lm Remote, App

### 900125 ARGOLIS-Z

surface-mounted light; aluminium, white / plastic, white  
 Aufbauleuchte; Alu, weiss / Kunststoff, weiss  
 luminaire en saillie; aluminium, blanc / plastique, blanc

L 285, B 285, H 30

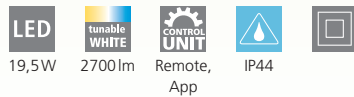

19,5W 2700lm Remote, App

### 900126 ARGOLIS-Z

surface-mounted light; aluminium, black / plastic, white  
 Aufbauleuchte; Alu, schwarz / Kunststoff, weiss  
 luminaire en saillie; aluminium, noir / plastique, blanc

H 30, Ø 285

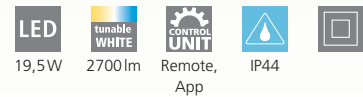

19,5W 2700lm Remote, App

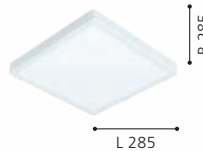



900121



900131



900258



### 900121 NEMA-Z

ground spike; plastic, steel, black  
 Erdspieß; Kunststoff, Stahl, schwarz  
 piquet de terre; plastique, acier, noir

L 125, H 115, Ø 90, ET 165

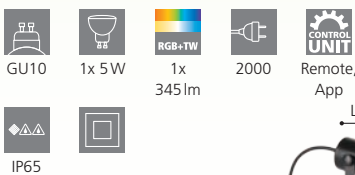

### 900131 EREMITANA-Z

wall light; zinc-plated steel, black  
 Wandleuchte; Stahl verzinkt, schwarz  
 Applique; acier galvanisé, noir

L 110, H 240, A 110

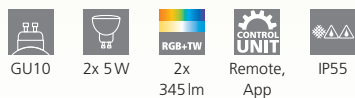

### 900258 BASALGO-Z

pedestal light; stainless steel, black / plastic, white  
 Sockelleuchte; Edelstahl, schwarz / Kunststoff, weiss  
 luminaire pour socle; acier inoxydable, noir / plastique, blanc

H 450, Ø 105

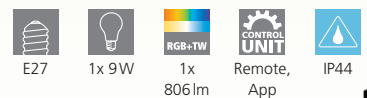



### NISIA-Z

The EGLO bulb 12253 is included in the delivery.

Das EGLO Leuchtmittel 12253 ist im Lieferumfang enthalten.

L'ampoule EGLO 12253 est incluse dans la livraison.



900266



900267



### 900266 NISIA-Z

pedestal light; stainless steel, stainless steel / plastic, white  
Sockelleuchte; Edelstahl, edelstahl / Kunststoff, weiss  
luminaire pour socle; acier inoxydable, acier inoxydable / plastique, blanc

H 525, Ø 200, Base: Ø 140

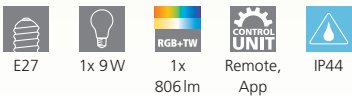

### 900267 NISIA-Z

floor light; stainless steel, stainless steel / plastic, white  
Stehleuchte; Edelstahl, edelstahl / Kunststoff, weiss  
lampadaire; acier inoxydable, acier inoxydable / plastique, blanc

H 980, Ø 200, Base: Ø 140

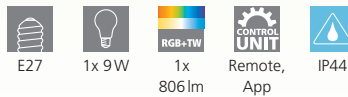

### 900265 NISIA-Z

wall light; stainless steel, stainless steel / plastic, white  
Wandleuchte; Edelstahl, edelstahl / Kunststoff, weiss  
Applique; acier inoxydable, acier inoxydable / plastique, blanc

L 200, H 315, A 220

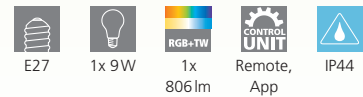



900265

LED



900268



900271



900272



900268 MONTEROLO-Z

floor light; plastic, white / plastic, white  
Stehleuchte; Kunststoff, weiss / Kunststoff, weiss  
lampadaire; plastique, blanc / plastique, blanc

H 300, Ø 300

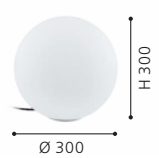
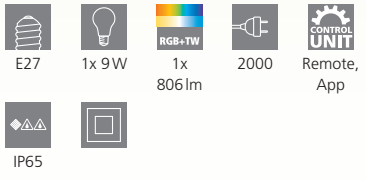

900271 MONTEROLO-Z

floor light; plastic, white / plastic, white  
Stehleuchte; Kunststoff, weiss / Kunststoff, weiss  
lampadaire; plastique, blanc / plastique, blanc

H 500, Ø 500

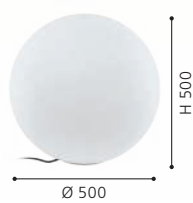
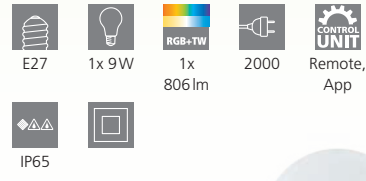

900272 MONTEROLO-Z

floor light; plastic, white / plastic, white  
Stehleuchte; Kunststoff, weiss / Kunststoff, weiss  
lampadaire; plastique, blanc / plastique, blanc

H 600, Ø 600

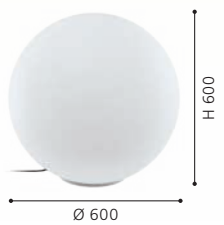
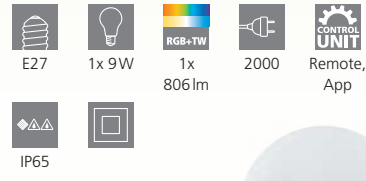





900269



## 900269 MONTEROLO-Z

floor light; plastic, white / plastic, white  
 Stehleuchte; Kunststoff, weiss / Kunststoff, weiss  
 lampadaire; plastique, blanc / plastique, blanc

H 390, Ø 390



E27



1x 9W



1x  
806lm



2000



Remote,  
App



IP65



## MONTEROLO-Z

The EGLO bulb 12253 is included in the delivery.

Das EGLO Leuchtmittel 12253 ist im Lieferumfang enthalten.

L'ampoule EGLO 12253 est incluse dans la livraison.





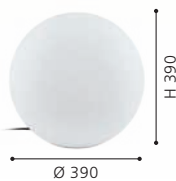







9 008606 232543

















## 12253 E27-LED-A60

 <b>806 lm</b>	 <b>2700-6500 K</b>	
 L 118, Ø 60	 dimmable via remote & app	
 9 W	 15000 h	
 220-240V, 50/60Hz	 9 W ~ 60 W	
 E27	 80 CRI	



## 12251 GU10-LED

 <b>345 lm</b>	 <b>2700-6500 K</b>	
 L 59, Ø 50	 dimmable via remote & app	 45°
 4.9 W	 15000 h	
 220-240V, 50/60Hz	 4.9 W ~ 50 W	
 GU10	 83 CRI	





### EGLO CONNECT.Z ILLUMINANT

One illuminant – numerous possibilities: 16.7 million colours and over 50,000 white tones ensure the right atmosphere in your home at all times. The illuminant can be controlled via remote control or app using Bluetooth technology: You can control the brightness or adjust colour tones – and all this without complicated installation and comfortably from the sofa.

But the illuminant can do much more: it can be expanded at will using intelligent mesh technology, and up to 50 illuminants can be grouped together. This makes it easy to create and program a wide variety of lighting scenarios. You can also use the app to select from a large number of pre-set lighting scenes.

Security is not neglected either, as the illuminants form a self-contained network and are therefore protected from external access.

### EGLO CONNECT.Z LEUCHTMITTEL

Ein Leuchtmittel – zahlreiche Möglichkeiten: 16,7 Millionen Farben und über 50.000 Weißtöne sorgen jederzeit für die richtige Stimmung in Ihrem Heim. Über die Bluetooth-Technologie kann das Leuchtmittel per Fernbedienung oder App gesteuert werden: Sie können die Helligkeit kontrollieren oder Farbtöne einstellen – und das alles ohne aufwändige Installation und bequem vom Sofa aus.

Aber das Leuchtmittel kann noch viel mehr: es lässt sich per intelligenter Mesh-Technologie beliebig erweitern, bis zu 50 Leuchtmittel sind hierbei gruppierbar. So lassen sich problemlos und einfach unterschiedlichste Lichtszenarien erstellen und programmieren. Mit der App können Sie aber auch aus einer Vielzahl vorgegebener Lichtstimmungen auswählen.

Auch die Sicherheit kommt nicht zu kurz, denn die Leuchtmittel bilden ein in sich geschlossenes Netzwerk und sind somit vor Zugriffen von Außen geschützt.

### AMPOULE EGLO CONNECT.Z

Une seule ampoule – de nombreuses possibilités : 16,7 millions de couleurs et plus de 50 000 tons de blanc assurent à tout moment la bonne ambiance dans votre maison. L'ampoule peut être commandée via une télécommande ou une appli, utilisant la technologie Bluetooth : Vous pouvez contrôler la luminosité ou régler les tons de couleurs – et tout cela sans installation compliquée et de manière confortablement depuis votre canapé.

Mais l'ampoule peut faire beaucoup plus : elle peut être étendue à volonté grâce à la technologie Mesh intelligentes, et jusqu'à 50 ampoules peuvent être regroupées. Il est ainsi facile de créer et de programmer une grande variété de scène lumineuse. Vous pouvez également utiliser l'appli pour sélectionner un grand nombre d'ambiance lumineuse prédéfinies.

La sécurité n'est pas négligée non plus, car les ampoules forment un réseau fermé et sont donc protégées des accès externes.

# MODERN

MODERN  
MODERNE

---

## CLEAR LINES

A straight-lined and minimalist design ensures a modern touch. The luminaires made of stainless steel, aluminium or steel, combined with refined glass elements, will make your outdoor area shine in a modern and yet timeless light.

---

## KLARE LINIEN

Geradliniges und minimalistisches Design sorgt für einen modernen Touch. Die Leuchten aus Edelstahl, Aluminium oder Stahl, kombiniert mit edlen Glaselementen, lassen Ihren Außenbereich modern und dennoch zeitlos erstrahlen.



---

## LIGNES DISTINCTIVES

Un design minimaliste et à lignes droites assure un flair moderne. Associés à de nobles éléments en verre, les luminaires en acier, acier inoxydable ou en aluminium laissent votre extérieur rayonner d'un aspect moderne et pourtant intemporel.



# OVERVIEW

 RIFORANO 38-39	 NEMBRO 40	 MANFRIA 40	 DONINNI 1 42-43	 BRIANZA 44	 PALOSCO 45	 MELZO 46	 FIUMICINO 48-49
 DONATORI 50	 PRATA VECCHIA 51	 CALDIERO 52	 STAGNONE 53	 NINNARELLA 55	 HELSINKI 56-57	 NISIA 58	 ONCALA 59
 BASALGO 1 59	 POLIENTO 59	 RUBIO 60	 SORRONARO 61	 MADRIZ 62	 CASAZZA 62-63	 ARGOLIS 2 64-65	 IPHAS 2 64-65
 SONELLA 66	 RONCO 66	 VENTO 1 69	 VENTO 2 69	 SALVANESCO 69	 FORNACI 70	 NIVAROLO 70	 FARINDOLA 71
 CULPINA 72	 CORNALE 72	 EREDITA 73	 KIBEA 73	 SITIA 74	 AZZINANO 74	 FANDINA 76	 SERRICELLA 76
 UGENTO 78	 TAPARITA 79	 SALITTA 79	 GORZANO 80	 PERNATE 80	 REDONDO 82	 MORINO 82	 SPIAZZINA 84
 PREDAZZO 84	 AGOLADA 85	 ROBLEDO 86	 BEVERLY 86	 STOCKHOLM 1 86	 TRONO STICK 87	 BOSARO 87	 BEVERLY 1 87



 This product is available in different colors and shapes. / Dieser Artikel ist in unterschiedlichen Farben und Formen verfügbar.  
Cet article est disponible en différentes couleurs et formes.



98725



98727



98728



### 98725 RIFORANO

wall light; cast aluminium, black / plastic, white  
 Wandleuchte; Aluguss, schwarz / Kunststoff, weiss  
 Applique; fonte d'aluminium, noir / plastique, blanc

### 98727 RIFORANO

pedestal light; cast aluminium, black / plastic, white  
 Sockelleuchte; Aluguss, schwarz / Kunststoff, weiss  
 luminaire pour socle; fonte d'aluminium, noir / plastique, blanc

### 98728 RIFORANO

floor light; cast aluminium, black / plastic, white  
 Stehleuchte; Aluguss, schwarz / Kunststoff, weiss  
 lampadaire; fonte d'aluminium, noir / plastique, blanc

L 110, H 290, A 85



2x 5W 1100lm



9 002759 987251



L 110, B 60, H 340



2x 5W 1100lm



9 002759 987275



L 110, B 60, H 770



2x 5W 1100lm



9 002759 987282







98726



120°, 6 m  
10 sec. - 8 min.

SAFETY &  
COMFORT

## 98726 RIFORANO

wall light; cast aluminium, black / plastic, white  
Wandleuchte; Aluguss, schwarz / Kunststoff, weiss  
Applique; fonte d'aluminium, noir / plastique, blanc

L 110, H 290, A 95

LED

2x 5 W

warm  
WHITE

1100lm



IP44





**98751**



**98096**



### 98751 NEMBRO

floor light; cast aluminium, black / plastic, white  
 Stehleuchte; Aluguss, schwarz / Kunststoff, weiss  
 lampadaire; fonte d'aluminium, noir / plastique, blanc

L 200, B 110, H 800



10W



1000lm



IP54



9 002759 987510



L 200

### 98096 MANFRIA

pedestal light; aluminium, anthracite, white  
 Sockelleuchte; Alu, anthrazit, weiss  
 luminaire pour socle; aluminium, gris anthracite, blanc

L 135, B 75, H 380



10W



1100lm



IP44



9 002759 980962



L 135

### 98097 MANFRIA

floor light; aluminium, anthracite, white  
 Stehleuchte; Alu, anthrazit, weiss  
 lampadaire; aluminium, gris anthracite, blanc

L 135, B 75, H 870



10W



1100lm



IP44



9 002759 980979

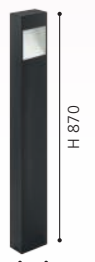

L 135



98097

LED



98266



98271



98269



### 98266 DONINNI 1

wall light; aluminium, white / plastic, white  
Wandleuchte; Alu, weiss / Kunststoff, weiss  
Applique; aluminium, blanc / plastique, blanc

L 135, B 120, H 75



### 98269 DONINNI 1

wall light; aluminium, anthracite / plastic, white  
Wandleuchte; Alu, anthrazit / Kunststoff, weiss  
Applique; aluminium, gris anthracite / plastique, blanc

L 135, B 120, H 75



### 98271 DONINNI 1

pedestal light; aluminium, anthracite / plastic, white  
Sockelleuchte; Alu, anthrazit / Kunststoff, weiss  
luminaire pour socle; aluminium, gris anthracite / plastique, blanc

L 135, B 75, H 400



9 002759 982669



L 135



9 002759 982690



L 135



9 002759 982713



L 135



98272

LED

HIGH  
IP

### 98272 DONINNI 1

floor light; aluminium, anthracite / plastic, white  
 Stehleuchte; Alu, anthrazit / Kunststoff, weiss  
 lampadaire; aluminium, gris anthracite / plastique, blanc

L 135, B 75, H 800

LED

6,2W

warm  
WHITE

550lm



IP65



9 002759 982720





98707

LED



98707

The movable light head allows you to select different lighting scenes as required.

Durch den beweglichen Leuchtenkopf können Sie nach Belieben unterschiedliche Lichtszenen wählen.

La tête de luminaire mobile vous permet de sélectionner différentes scènes lumineuses en fonction de vos besoins.

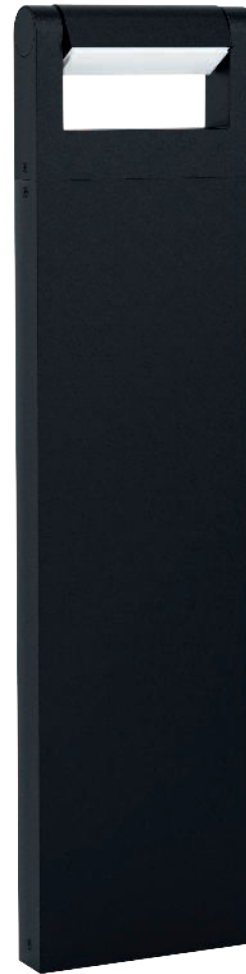

98708

LED

### 98707 BRIANZA

wall light; cast aluminium, black  
Wandleuchte; Aluguss, schwarz  
Applique; fonte d'aluminium, noir

L 200, H 50, A 140



4,8W



550lm



IP44



9 002759 987077

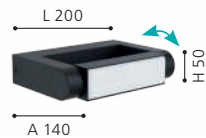

### 98708 BRIANZA

floor light; cast aluminium, black  
Stehleuchte; Aluguss, schwarz  
lampadaire; fonte d'aluminium, noir

L 200, B 45, H 800



4,8W



550lm



IP44



9 002759 987084





98738



90°, 6 m  
10 sec. -  
12 min.

**SAFETY &  
COMFORT**



98737



### 98738 PALOSCO

wall light; zinc-plated steel, black / plastic, transparent  
Wandleuchte; Stahl verzinkt, schwarz / Kunststoff, transparent  
Applique; acier galvanisé, noir / plastique, transparent

L 115, H 170, A 155



4,9W



360lm



IP44



9 002759 987381

### 98737 PALOSCO

wall light; zinc-plated steel, black / plastic, transparent  
Wandleuchte; Stahl verzinkt, schwarz / Kunststoff, transparent  
Applique; acier galvanisé, noir / plastique, transparent

L 115, H 170, A 155



4,9W



360lm



IP44



9 002759 987374

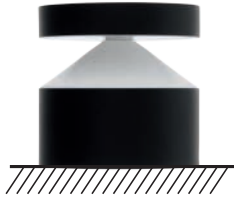
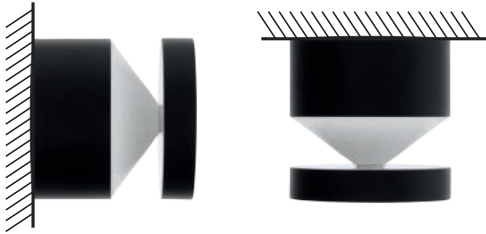

### 97303

This lamp has diverse uses: It can be installed on the wall or on the ceiling. The lamps variable design also permits floor placement.

Diese Leuchte ist vielseitig einsetzbar: sie kann sowohl an der Wand, als auch an der Decke montiert werden. Ebenfalls ist durch das variable Design der Leuchte eine Bodenplatzierung möglich.

Ces luminaire est application multiple : elle peut être aussi bien montés sur le mur qu'attachés au plafond. Un placement au sol est aussi rendu possible par le design variable des luminaires.



97632



### 97632 MELZO

pedestal light; cast aluminium, black / plastic, transparent  
Sockelleuchte; Aluguss, schwarz / Kunststoff, transparent  
luminaire pour socle; fonte d'aluminium, noir / plastique, transparent

H 450, Ø 135



1x 11W 1300lm



9 002759 976323



### 97303 MELZO

wall light; cast aluminium, black / plastic, transparent  
Wandleuchte; Aluguss, schwarz / Kunststoff, transparent  
Applique; fonte d'aluminium, noir / plastique, transparent

H 130, Ø 135



1x 11W 1300lm



9 002759 973032



### 97304 MELZO

floor light; cast aluminium, black / plastic, transparent  
Stehleuchte; Aluguss, schwarz / Kunststoff, transparent  
lampadaire; fonte d'aluminium, noir / plastique, transparent

H 990, Ø 135



1x 11W 1300lm



9 002759 973049







97303

LED



97304

LED





98148



98149



100°, 5 m  
5 sec. - 5 min.

**SAFETY &  
COMFORT**



98151



### 98148 FIUMICINO

wall light; aluminium, black / plastic, white  
Wandleuchte; Alu, schwarz / Kunststoff, weiss  
Applique; aluminium, noir / plastique, blanc

L 70, H 180, A 190



11,5W 1200lm



9 002759 981488



### 98149 FIUMICINO

wall light; aluminium, black / plastic, white  
Wandleuchte; Alu, schwarz / Kunststoff, weiss  
Applique; aluminium, noir / plastique, blanc

L 70, H 180, A 190



11,5W 1200lm



9 002759 981495



### 98151 FIUMICINO

pedestal light; aluminium, black / plastic, white  
Sockelleuchte; Alu, schwarz / Kunststoff, weiss  
luminaire pour socle; aluminium, noir / plastique, blanc

H 450, Base: B 110, T 80



11,5W 1200lm



9 002759 981518





### 98152 FIUMICINO

floor light; aluminium, black / plastic, white  
Stehleuchte; Alu, schwarz / Kunststoff, weiss  
lampadaire; aluminium, noir / plastique, blanc

H 900, Base: B 110, T 80



11,5W



1200lm



IP44



9 002759 981525



98152

LED



**98701**



**98702**



**98703**

### 98701 DONATORI

wall light; aluminium, plastic, black / glass, clear  
Wandleuchte; Alu, Kunststoff, schwarz / Glas, klar  
Applique; aluminium, plastique, noir / verre, transparent

L 155, H 260, A 190



9 002759 987015



### 98702 DONATORI

pedestal light; cast aluminium, black / glass, clear  
Sockelleuchte; Aluguss, schwarz / Glas, klar  
luminaire pour socle; fonte d'aluminium, noir / verre, transparent

H 310, Ø 155, Base: Ø 130

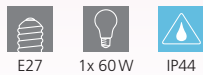

9 002759 987022



### 98703 DONATORI

floor light; cast aluminium, black / glass, clear  
Stehleuchte; Aluguss, schwarz / Glas, klar  
lampadaire; fonte d'aluminium, noir / verre, transparent

H 990, Ø 155, Base: Ø 130

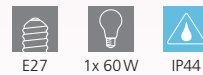

9 002759 987039

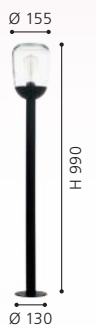



98731

### 98731 PRATA VECCHIA

wall light; zinc-plated steel, black / plastic, white  
Wandleuchte; Stahl verzinkt, schwarz / Kunststoff, weiss  
Applique; acier galvanisé, noir / plastique, blanc

L 200, H 260, A 285



E27



1x 28W



IP44





97451



90°, 6 m  
10 sec. - 10 min.

**SAFETY &  
COMFORT**



97146

### 97451 CALDIERO

wall light; zinc-plated steel, anthracite / plastic, white  
Wandleuchte; Stahl verzinkt, anthrazit / Kunststoff, weiss  
Applique; acier galvanisé, gris anthracite / plastique, blanc

L 140, H 240, A 185



E27



1x 10W



IP44



9 002759 974510



### 97146 CALDIERO

wall light; zinc-plated steel, anthracite / plastic, white  
Wandleuchte; Stahl verzinkt, anthrazit / Kunststoff, weiss  
Applique; acier galvanisé, gris anthracite / plastique, blanc

L 140, H 240, A 185



E27



1x 10W



IP44



9 002759 971465





### 900691 STAGNONE

wall light; aluminium, steel, black / glass, clear  
 Wandleuchte; Alu, Stahl, schwarz / Glas, klar  
 Applique; aluminium, acier, noir / verre, transparent

L 100, H 205, A 125



### 900692 STAGNONE

pedestal light; aluminium, steel, black / glass, clear  
 Sockelleuchte; Alu, Stahl, schwarz / Glas, klar  
 luminaire pour socle; aluminium, acier, noir / verre, transparent

L 100, B 125, H 1000





900688

LED

22-23



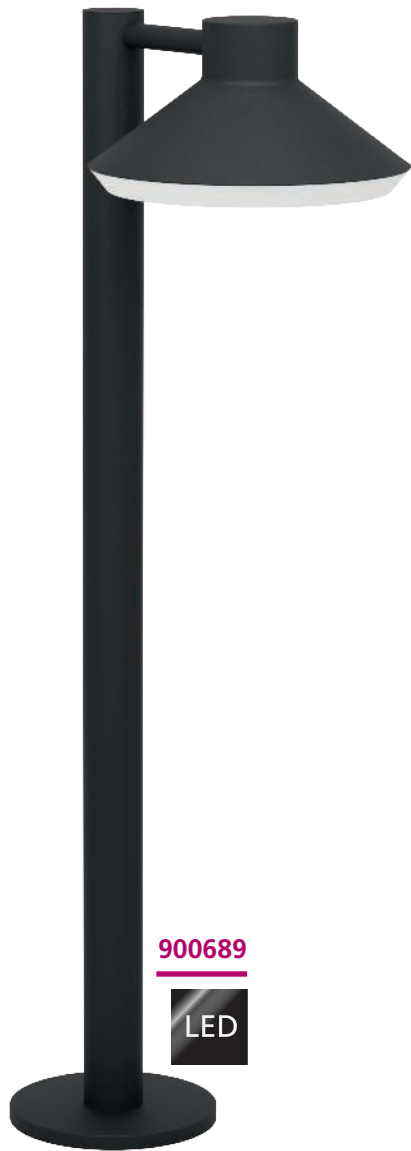

900689

LED



### 900688 NINNARELLA

wall light; steel, black / plastic, white  
Wandleuchte; Stahl, schwarz / Kunststoff, weiss  
Applique; acier, noir / plastique, blanc

L 205, H 110, A 240



GU10



1x 4,6W



1x  
warm  
WHITE  
400lm



IP44



9 008606 261833

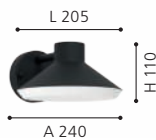

### 900689 NINNARELLA

pedestal light; steel, black / plastic, white  
Sockelleuchte; Stahl, schwarz / Kunststoff, weiss  
luminaire pour socle; acier, noir / plastique, blanc

L 250, B 205, H 745



GU10



1x 4,6W



1x  
warm  
WHITE  
400lm



IP44



9 008606 261840





81751



83278



110°, 5 m  
15 sec. - 7  
min.

**SAFETY &  
COMFORT**



81753



### 81751 HELSINKI

floor light; stainless steel, stainless steel / plastic, white  
Stehleuchte; Edelstahl, edelstahl / Kunststoff, weiss  
lampadaire; acier inoxydable, acier inoxydable / plastique, blanc

H 450, Ø 75, Base: Ø 115



### 83278 HELSINKI

wall light; stainless steel, stainless steel / plastic, white  
Wandleuchte; Edelstahl, edelstahl / Kunststoff, weiss  
Applique; acier inoxydable, acier inoxydable / plastique, blanc

H 425, Ø 75, A 165



### 81753 HELSINKI

wall light; stainless steel, stainless steel / plastic, white  
Wandleuchte; Edelstahl, edelstahl / Kunststoff, weiss  
Applique; acier inoxydable, acier inoxydable / plastique, blanc

H 390, Ø 75, A 165

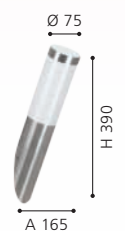



83279



110°, 5 m  
15 sec. - 7  
min.

**SAFETY &  
COMFORT**



83281



110°, 5 m  
15 sec. - 7  
min.

**SAFETY &  
COMFORT**



81752



HIGH  
IP

### 83279 HELSINKI

floor light; stainless steel, stainless steel / plastic, white  
Stehleuchte; Edelstahl, edelstahl / Kunststoff, weiss  
lampadaire; acier inoxydable, acier inoxydable / plastique, blanc

H 450, Ø 75, Base: Ø 115



E27



1x 12 W



IP44



9 002759 832797

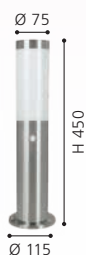

### 83281 HELSINKI

floor light; stainless steel, stainless steel / plastic, white  
Stehleuchte; Edelstahl, edelstahl / Kunststoff, weiss  
lampadaire; acier inoxydable, acier inoxydable / plastique, blanc

H 1100, Ø 75, Base: Ø 115



E27



1x 12 W



IP44



9 002759 832810

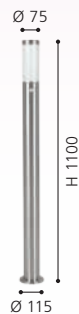

### 81752 HELSINKI

floor light; stainless steel, stainless steel / plastic, white  
Stehleuchte; Edelstahl, edelstahl / Kunststoff, weiss  
lampadaire; acier inoxydable, acier inoxydable / plastique, blanc

H 1100, Ø 75, Base: Ø 115



E27



1x 12 W



IP65



9 002759 817527

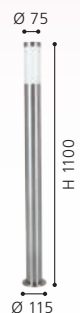



### 30205 NISIA

wall light; stainless steel, stainless steel / satin glass, white  
 Wandleuchte; Edelstahl, edelstahl / Glas satiniert, weiss  
 Applique; acier inoxydable, acier inoxydable / verre satiné, blanc

L 200, H 360, A 240



### 30206 NISIA

floor light; stainless steel, stainless steel / satin glass, white  
 Stehleuchte; Edelstahl, edelstahl / Glas satiniert, weiss  
 lampadaire; acier inoxydable, acier inoxydable / verre satiné, blanc

H 500, Ø 200, Base: Ø 130

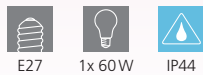

### 30207 NISIA

floor light; stainless steel, stainless steel / satin glass, white  
 Stehleuchte; Edelstahl, edelstahl / Glas satiniert, weiss  
 lampadaire; acier inoxydable, acier inoxydable / verre satiné, blanc

H 1000, Ø 200, Base: Ø 130

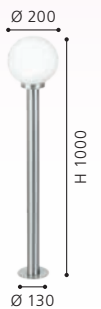



95982

LED



94278

LED



95016

### 95982 ONCALA

wall light; stainless steel, stainless steel / satin glass, white  
Wandleuchte; Edelstahl, edelstahl / Glas satiniert, weiss  
Applique; acier inoxydable, acier inoxydable / verre satiné, blanc

L 150, H 140, A 190



12W



1300lm



IP44



9 002759 959821



### 94278 BASALGO 1

floor light; stainless steel, stainless steel / plastic, clear, white  
Stehleuchte; Edelstahl, edelstahl / Kunststoff, klar, weiss  
lampadaire; acier inoxydable, acier inoxydable / plastique, transparent, blanc

H 450, Ø 105



1x 3,7W



330lm



IP44



9 002759 942786



### 95016 POLIENTO

wall light; stainless steel, stainless steel / plastic, glass, clear, white  
Wandleuchte; Edelstahl, edelstahl / Kunststoff, Glas, klar, weiss  
Applique; acier inoxydable, acier inoxydable / plastique, verre, transparent, blanc

L 150, H 325, A 195



E27



1x 28W



IP44



9 002759 950163





99572



99573



120°, 5 m  
5 sec. - 5 min.

**SAFETY & COMFORT**

### 99572 RUBIO

wall light; cast aluminium, black / plastic, white  
Wandleuchte; Aluguss, schwarz / Kunststoff, weiss  
Applique; fonte d'aluminium, noir / plastique, blanc

L 170, H 150, A 190



E27



1x 15 W



IP64



9 002759 995720



### 99573 RUBIO

wall light; cast aluminium, black / plastic, white  
Wandleuchte; Aluguss, schwarz / Kunststoff, weiss  
Applique; fonte d'aluminium, noir / plastique, blanc

L 170, H 170, A 195



E27



1x 15 W



IP44



9 002759 995737





99578



99579



120°, 5 m  
5 sec. - 5 min.

**SAFETY &  
COMFORT**



99578

This luminaire can be mounted upwards or downwards.

Diese Leuchte kann aufwärts oder abwärts montiert werden.

Cette luminaire peut être montée vers le haut ou vers le bas.

### 99579 SORRONARO

wall light; aluminium, plastic, black / plastic, transparent  
Wandleuchte; Alu, Kunststoff, schwarz / Kunststoff, transparent  
Applique; aluminium, plastique, noir / plastique, transparent

L 170, H 120, A 150



10,5W



1000lm



IP44



9 002759 995799



### 99578 SORRONARO

wall light; aluminium, plastic, black / plastic, transparent  
Wandleuchte; Alu, Kunststoff, schwarz / Kunststoff, transparent  
Applique; aluminium, plastique, noir / plastique, transparent

L 170, H 50, A 150



10,5W



1000lm



IP64



9 002759 995782

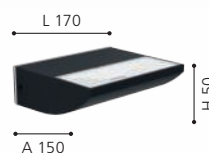



99584



120°, 6 m  
5 sec. - 10 min.

**SAFETY &  
COMFORT**



99583



99521



105°, 6 m  
5 sec. - 10 min.

**SAFETY &  
COMFORT**

### 99584 MADRIZ

wall light; cast aluminium, black / plastic, white  
Wandleuchte; Aluguss, schwarz / Kunststoff, weiss  
Applique; fonte d'aluminium, noir / plastique, blanc

L 230, H 190, A 50



2x 3,6W



740lm



IP44



9 002759 995843



L 230

H 190

### 99583 MADRIZ

wall light; cast aluminium, black / plastic, white  
Wandleuchte; Aluguss, schwarz / Kunststoff, weiss  
Applique; fonte d'aluminium, noir / plastique, blanc

L 230, H 190, A 50



2x 3,6W



740lm



IP44



9 002759 995836



L 230

H 190

### 99521 CASAZZA

wall light; zinc-plated steel, black / plastic, white  
Wandleuchte; Stahl verzinkt, schwarz / Kunststoff, weiss  
Applique; acier galvanisé, noir / plastique, blanc

L 200, H 400, A 80



16W



2350lm



IP44



9 002759 995218

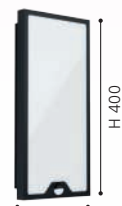

L 200

H 400





99522



105°, 6 m  
5 sec. - 10 min.

**SAFETY &  
COMFORT**



99533



99534



### 99522 CASAZZA

wall light; zinc-plated steel, black / plastic, white  
Wandleuchte; Stahl verzinkt, schwarz / Kunststoff, weiss  
Applique; acier galvanisé, noir / plastique, blanc

L 250, H 570, A 80



18,5 W



2650 lm



IP44



9 002759 995225

### 99533 CASAZZA

wall light; zinc-plated steel, black / plastic, white  
Wandleuchte; Stahl verzinkt, schwarz / Kunststoff, weiss  
Applique; acier galvanisé, noir / plastique, blanc

L 200, H 400, A 65



16 W



2350 lm



IP44



9 002759 995331

### 99534 CASAZZA

wall light; zinc-plated steel, black / plastic, white  
Wandleuchte; Stahl verzinkt, schwarz / Kunststoff, weiss  
Applique; acier galvanisé, noir / plastique, blanc

L 250, H 570, A 65



18,5 W



2650 lm



IP44



9 002759 995348



900278

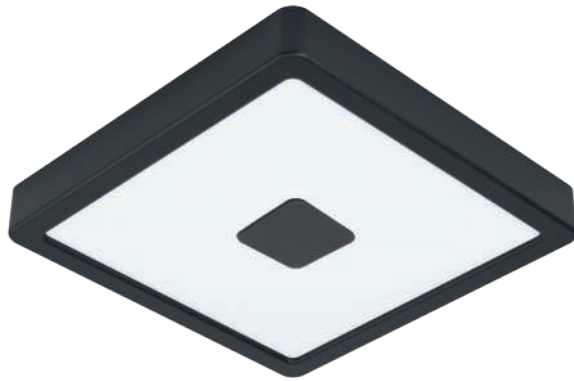

900283



900281



### 900278 ARGOLIS 2

surface-mounted light; steel, black / plastic, white  
Aufbauleuchte; Stahl, schwarz / Kunststoff, weiss  
luminaire en saillie; acier, noir / plastique, blanc

H 30, Ø 285



20,5W 2400lm

### 900281 ARGOLIS 2

surface-mounted light; steel, black / plastic, white  
Aufbauleuchte; Stahl, schwarz / Kunststoff, weiss  
luminaire en saillie; acier, noir / plastique, blanc

L 285, B 285, H 30



20,5W 2400lm

### 900283 IPHIAS 2

surface-mounted light; steel, black / plastic, white  
Aufbauleuchte; Stahl, schwarz / Kunststoff, weiss  
luminaire en saillie; acier, noir / plastique, blanc

L 210, B 210, H 30



17W 2000lm



9 008606 232635



9 008606 232659



9 008606 232611

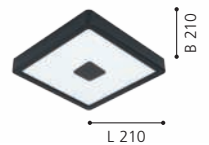



900277



900282



900279



### 900277 ARGOLIS 2

surface-mounted light; steel, white / plastic, white  
Aufbauleuchte; Stahl, weiss / Kunststoff, weiss  
luminaire en saillie; acier, blanc / plastique, blanc

H 30, Ø 285



20,5W 2400lm

### 900279 ARGOLIS 2

surface-mounted light; steel, white / plastic, white  
Aufbauleuchte; Stahl, weiss / Kunststoff, weiss  
luminaire en saillie; acier, blanc / plastique, blanc

L 285, B 285, H 30



20,5W 2400lm

### 900282 IPHIAS 2

surface-mounted light; steel, white / plastic, white  
Aufbauleuchte; Stahl, weiss / Kunststoff, weiss  
luminaire en saillie; acier, blanc / plastique, blanc

L 210, B 210, H 30



17W 2000lm



9 008606 232628



9 008606 232642

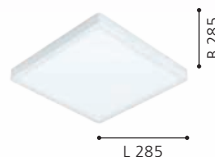

9 008606 232604

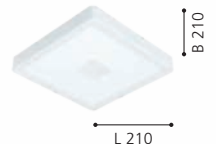



### 94871 SONELLA

wall / ceiling light; plastic, white / plastic, white  
Wand- / Deckenleuchte; Kunststoff, weiss / Kunststoff, weiss  
Applique/Plafonnier; plastique, blanc / plastique, blanc

### 94872 SONELLA

wall / ceiling light; plastic, anthracite / plastic, white  
Wand- / Deckenleuchte; Kunststoff, anthrazit / Kunststoff, weiss  
Applique/Plafonnier; plastique, gris anthracite / plastique, blanc

### 900297 RONCO

wall / ceiling light; steel, white / plastic, white  
Wand- / Deckenleuchte; Stahl, weiss / Kunststoff, weiss  
Applique/Plafonnier; acier, blanc / plastique, blanc

L 215, H 215, A 70

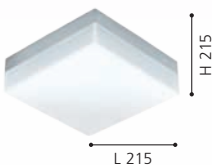

L 215, H 215, A 70

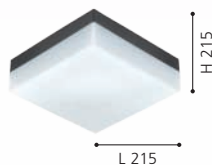

H 55, Ø 220





900297

LED



94121

LED





96365



98705



110°, 8 m  
8 sec. - 5 min.

**SAFETY &  
COMFORT**

### 94121 VENTO 1

wall / ceiling light; stainless steel, stainless steel / glass, white painted  
Wand- / Deckenleuchte; Edelstahl, edelstahl / Glas, weiss lackiert  
Applique/Plafonnier; acier inoxydable, acier inoxydable / verre, blanc laqué

Ø 285, A 80



11 W 1300lm



Ø 285

### 96365 VENTO 2

wall / ceiling light; stainless steel, stainless steel / plastic, white  
Wand- / Deckenleuchte; Edelstahl, edelstahl / Kunststoff, weiss  
Applique/Plafonnier; acier inoxydable, acier inoxydable / plastique, blanc

Ø 185, A 70



1x 5,4 W 450lm



Ø 185

### 98705 SALVANESCO

wall light; cast aluminium, black / plastic, white  
Wandleuchte; Aluguss, schwarz / Kunststoff, weiss  
Applique; fonte d'aluminium, noir / plastique, blanc

L 180, H 240, A 90

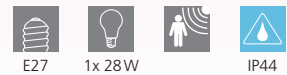

E27 1x 28 W



9 002759 987053



A 90



9 002759 941215



9 002759 963651



900673



900675



900674



90°, 8 m  
10 sec. - 8 min.

**SAFETY &  
COMFORT**

### 900673 FORNACI

wall light; steel, black / plastic, white  
Wandleuchte; Stahl, schwarz / Kunststoff, weiss  
Applique; acier, noir / plastique, blanc

### 900674 FORNACI

wall light; steel, black / plastic, white  
Wandleuchte; Stahl, schwarz / Kunststoff, weiss  
Applique; acier, noir / plastique, blanc

### 900675 NIVAROLO

wall light; steel, black / plastic, white  
Wandleuchte; Stahl, schwarz / Kunststoff, weiss  
Applique; acier, noir / plastique, blanc

L 160, H 135, A 190



L 160, H 135, A 190



L 145, H 135, A 185

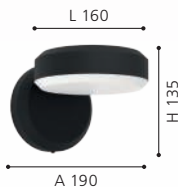
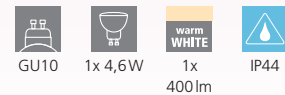





900682

### 900682 FARINDOLA

wall light; steel, black / plastic, white  
Wandleuchte; Stahl, schwarz / Kunststoff, weiss  
Applique; acier, noir / plastique, blanc

L 115, H 325, A 155



E27



1x 25 W



IP44



9 008606 261703





98088



3x 1x  
0-9 a-f

97289, 98088

Letters and numbers included in delivery.

Buchstaben und Zahlen im Lieferumfang enthalten.

Les lettres et les nombres sont inclus dans la livraison.



97289



SAFETY & COMFORT



97289, 98088

Automatic illumination: This photoelectric lighting controller is used for controlling lighting systems for building fronts and automatically switches light 'ON' at dusk automatically 'OFF' again at dawn.

Automatische Beleuchtung: Der Day & Night Sensor dient zur Steuerung von Beleuchtungsanlagen an Hausfronten und schaltet bei Dämmerung automatisch Licht AN und am Morgen automatisch wieder AUS.

Un éclairage automatique : Le Interrupteur crépusculaire pour la commande des installations d'éclairage pour les façades de maison e il allume automatiquement la lumière au crépuscule et l'éteint automatiquement à l'aube.

### 98088 CULPINA

wall light; aluminium, anthracite / plastic, white  
Wandleuchte; Alu, anthrazit / Kunststoff, weiss  
Applique; aluminium, gris anthracite / plastique, blanc

L 190, H 270, A 80



1x 10W 1100lm



9 002759 980887



### 97289 CORNALE

wall light; plastic, anthracite / plastic, white  
Wandleuchte; Kunststoff, anthrazit / Kunststoff, weiss  
Applique; plastique, gris anthracite / plastique, blanc

L 215, H 215, A 70



1x 8,2W 1000lm



9 002759 972899





99585

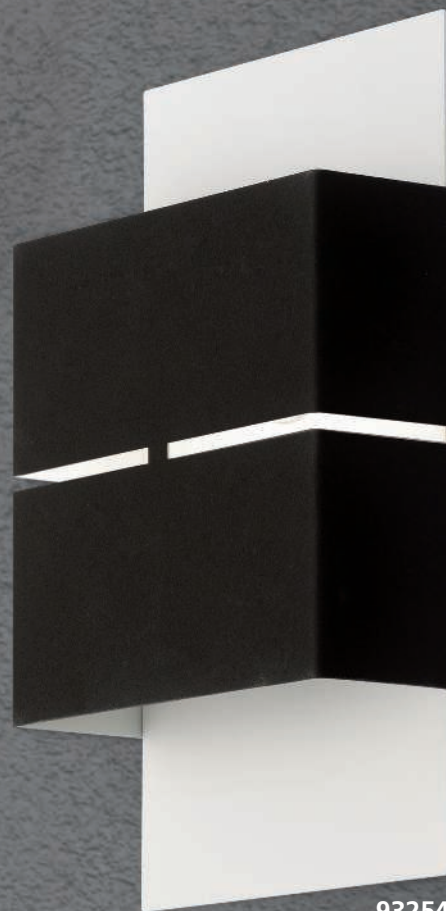

93254



### 99585 EREDITA

wall light; stainless steel, plastic, anthracite / satin glass, white  
Wandleuchte; Edelstahl, Kunststoff, anthrazit / Glas satiniert, weiss

Applique; acier inoxydable, plastique, gris anthracite / verre satiné, blanc

L 180, H 260, A 105



10W



1000lm



IP44



9 002759 995850

### 93254 KIBEA

wall light; zinc-plated steel, white, anthracite  
Wandleuchte; Stahl verzinkt, weiss, anthrazit

Applique; acier galvanisé, blanc, gris anthracite

L 150, H 260, A 75



2x 2,5W



460lm



IP54



9 002759 932541



95988

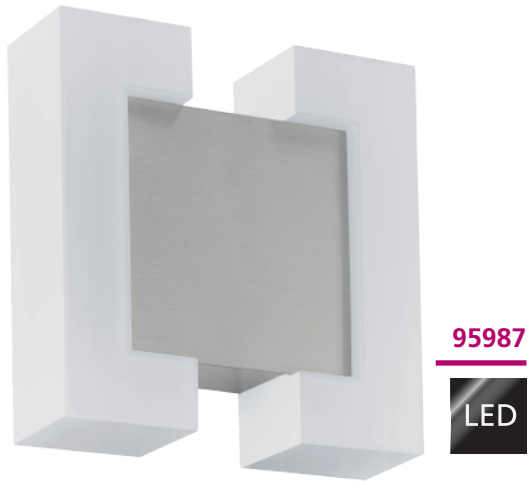

95987



### 95987 SITIA

wall light; zinc-plated steel, satin nickel / plastic, white  
Wandleuchte; Stahl verzinkt, nickel-matt / Kunststoff, weiss  
Applique; acier galvanisé, nickel mat / plastique, blanc

L 180, H 180, A 55



2x 4,8W 1100lm



9 002759 959876

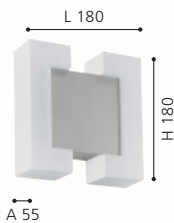

### 95988 SITIA

wall light; zinc-plated steel, anthracite / plastic, white  
Wandleuchte; Stahl verzinkt, anthrazit / Kunststoff, weiss  
Applique; acier galvanisé, gris anthracite / plastique, blanc

L 180, H 180, A 55



2x 4,8W 1100lm



9 002759 959883

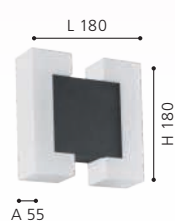

### 97159 AZZINANO

wall light; zinc-plated steel, silver / plastic, white  
Wandleuchte; Stahl verzinkt, silber / Kunststoff, weiss  
Applique; acier galvanisé, argent / plastique, blanc

L 185, H 115, A 125



2x 5,6W 1400lm



9 002759 971595

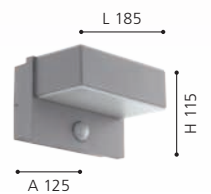

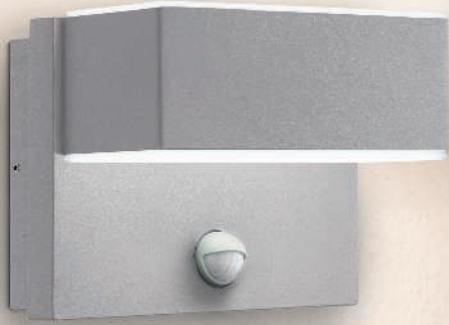

97159

LED



120°, 6 m  
10 sec. - 8 min.

**SAFETY &  
COMFORT**

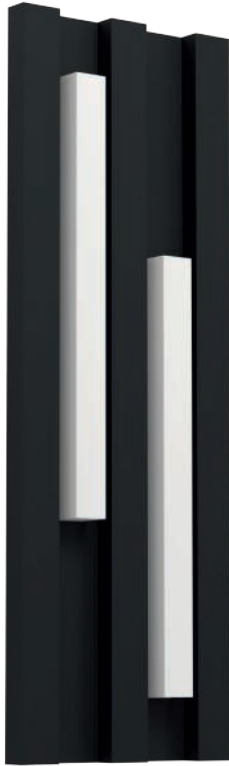

**900118**



**900119**



**900118 FANDINA**

wall light; zinc-plated steel, black / plastic, white  
 Wandleuchte; Stahl verzinkt, schwarz / Kunststoff, weiss  
 Applique; acier galvanisé, noir / plastique, blanc

L 145, H 415, A 55



2x 4,2W 1000lm



9 008606 230150



**900119 FANDINA**

wall light; zinc-plated steel, white / plastic, white  
 Wandleuchte; Stahl verzinkt, weiss / Kunststoff, weiss  
 Applique; acier galvanisé, blanc / plastique, blanc

L 145, H 415, A 55



2x 4,2W 1000lm



9 008606 230167



**900133 SERRICELLA**

wall light; zinc-plated steel, black / plastic, white  
 Wandleuchte; Stahl verzinkt, schwarz / Kunststoff, weiss  
 Applique; acier galvanisé, noir / plastique, blanc

L 100, H 495, A 60



2x 4,5W 1100lm



9 008606 230174



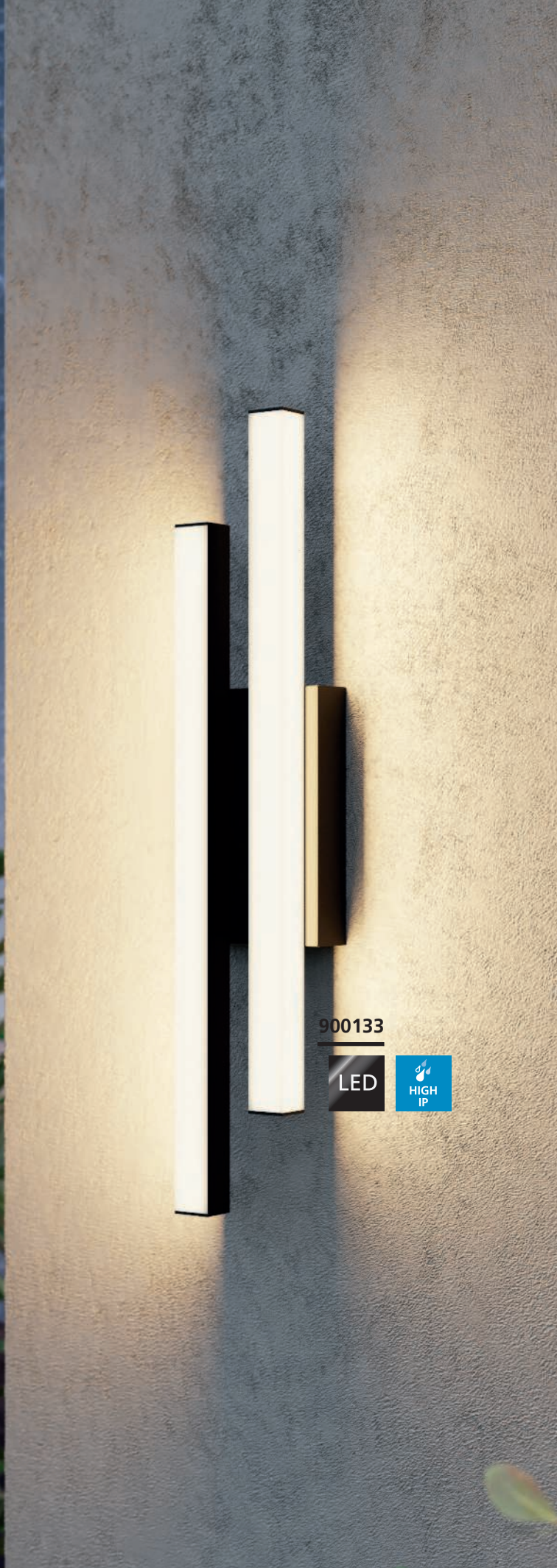

900133

LED

HIGH  
IP



900709

LED



## UGENTO

Regarding to its flexible head, this lamp can be radiate forward or backward.

Diese Leuchte kann durch ihren flexiblen Kopf nach vorne oder hinten strahlen.

Grâce à sa tête flexible, cette lampe peut être rayonner vers l'avant ou vers l'arrière.



## 900709 UGENTO

wall light; steel, black / plastic, white  
Wandleuchte; Stahl, schwarz / Kunststoff, weiss  
Applique; acier, noir / plastique, blanc

L 60, H 315, A 95



2x 4,5W



920lm



IP44



9 008606 261789

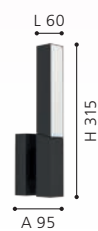



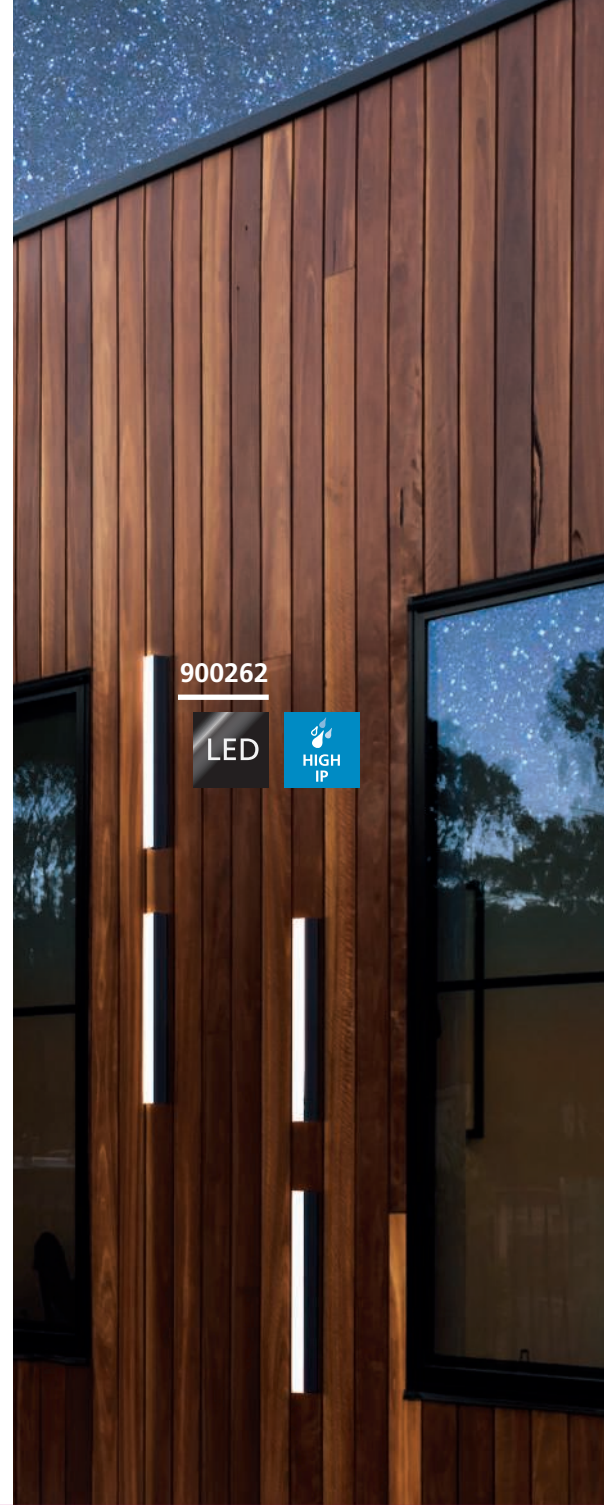

### 900681 TAPARITA

wall light; steel, black / plastic, white  
 Wandleuchte; Stahl, schwarz / Kunststoff, weiss  
 Applique; acier, noir / plastique, blanc

L 90, H 440, A 110



### 900261 SALITTA

surface-mounted light; aluminium, steel, black / plastic, white  
 Aufbauleuchte; Alu, Stahl, schwarz / Kunststoff, weiss  
 luminaire en saillie; aluminium, acier, noir / plastique, blanc

L 380, B 55, H 55



### 900262 SALITTA

surface-mounted light; aluminium, steel, black / plastic, white  
 Aufbauleuchte; Alu, Stahl, schwarz / Kunststoff, weiss  
 luminaire en saillie; aluminium, acier, noir / plastique, blanc

L 580, B 55, H 55





97222



97307



### 97222 GORZANO

wall light; zinc-plated steel, anthracite / plastic, satined  
Wandleuchte; Stahl verzinkt, anthrazit / Kunststoff, satiniert  
Applique; acier galvanisé, gris anthracite / plastique, satiné

L 80, H 290, A 105



1x 4,8W 550lm



9 002759 972226



### 97307 PERNATE

wall light; cast aluminium, anthracite / plastic, white  
Wandleuchte; Aluguss, anthrazit / Kunststoff, weiss  
Applique; fonte d'aluminium, gris anthracite / plastique, blanc

L 250, H 235, A 170



11W 1250lm



9 002759 973070



### 97308 PERNATE

wall light; cast aluminium, anthracite / plastic, white  
Wandleuchte; Aluguss, anthrazit / Kunststoff, weiss  
Applique; fonte d'aluminium, gris anthracite / plastique, blanc

L 250, H 235, A 170



11W 1250lm



9 002759 973087





97308



120°, 6 m  
10 sec. - 8 min.

**SAFETY &  
COMFORT**



93368

LED



93318

LED

### 93368 REDONDO

wall light; cast aluminium, anthracite  
Wandleuchte; Aluguss, anthrazit  
Applique; fonte d'aluminium, gris anthracite

L 160, H 175, A 125



2x 2,5W 460lm



IP44



9 002759 933685



### 93318 MORINO

wall light; cast aluminium, white  
Wandleuchte; Aluguss, weiss  
Applique; fonte d'aluminium, blanc

L 140, H 180, A 105



2x 2,5W 460lm



IP44



9 002759 933180

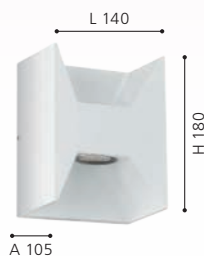

### 93319 MORINO

wall light; cast aluminium, anthracite  
Wandleuchte; Aluguss, anthrazit  
Applique; fonte d'aluminium, gris anthracite

L 140, H 180, A 105



2x 2,5W 460lm



IP44



9 002759 933197

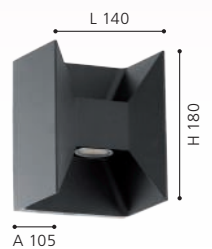

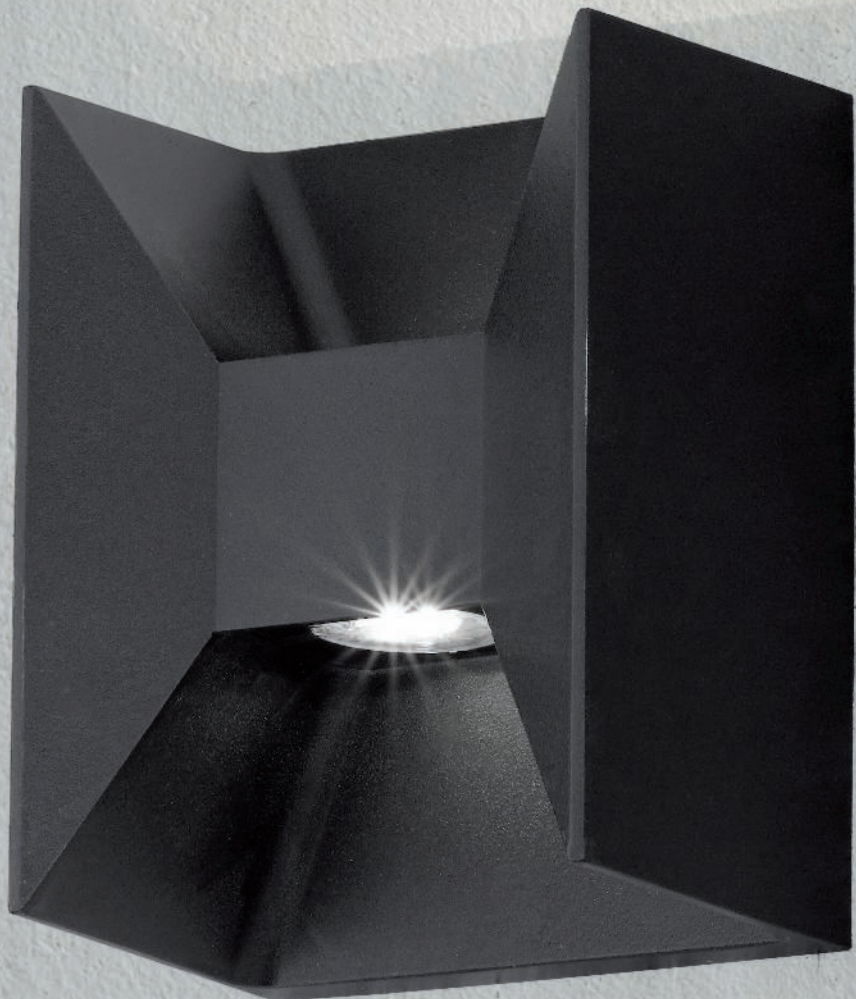

93319

LED



**900132**



**93994**



**900132 SPIAZZINA**

wall light; zinc-plated steel, black, white  
 Wandleuchte; Stahl verzinkt, schwarz, weiss  
 Applique; acier galvanisé, noir, blanc

L 80, H 355, A 140



2x 2,5W



360lm



IP55

L 140



A 140



9 008606 230211

**93994 PREDAZZO**

wall light; zinc-plated steel, anthracite, white  
 Wandleuchte; Stahl verzinkt, anthrazit, weiss  
 Applique; acier galvanisé, gris anthracite, blanc

L 140, H 210, A 75



2x 2,5W



460lm



IP44

L 140



A 75



9 002759 939946



94804

LED

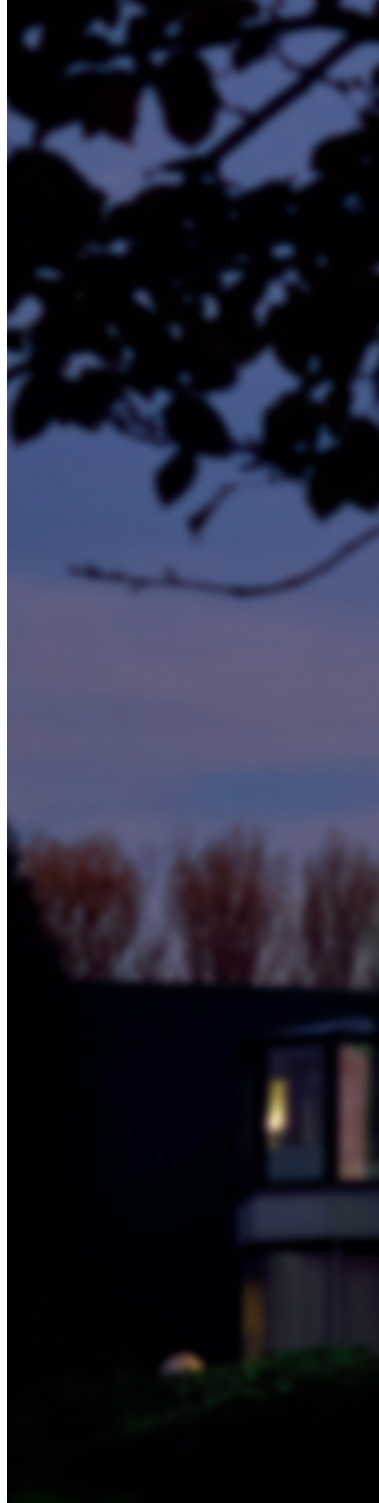

94803

LED

### 94804 AGOLADA

wall light; zinc-plated steel, black, copper  
Wandleuchte; Stahl verzinkt, schwarz, kupfer  
Applique; acier galvanisé, noir, cuivre

L 75, H 360, A 110



2x 3,7W



660lm



IP44



9 002759 948047

### 94803 AGOLADA

wall light; stainless steel, stainless steel, white  
Wandleuchte; Edelstahl, edelstahl, weiss  
Applique; acier inoxydable, acier inoxydable, blanc

L 75, H 360, A 110



2x 3,7W



660lm



IP44



9 002759 948030



### 96013 ROBLEDO

wall light; stainless steel, stainless steel / plastic, transparent  
Wandleuchte; Edelstahl, edelstahl / Kunststoff, transparent  
Applique; acier inoxydable, acier inoxydable / plastique, transparent

L 75, H 260, A 120



2x 3,7W 660lm



### 86541 BEVERLY

wall light; stainless steel, stainless steel, silver / satin glass, white  
Wandleuchte; Edelstahl, edelstahl, silber / Glas satiniert, weiss  
Applique; acier inoxydable, acier inoxydable, argent / verre satiné, blanc

L 200, H 350, A 135

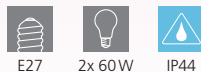

### 93268 STOCKHOLM 1

wall light; stainless steel, stainless steel / glass, clear  
Wandleuchte; Edelstahl, edelstahl / Glas, klar  
Applique; acier inoxydable, acier inoxydable / verre, transparent

Ø 100



1x 400lm







94779

LED



94128

LED



110°, 5 m  
15 sec. - 7 min.

**SAFETY &  
COMFORT**



94799

LED

### 94128 TRONO STICK

wall light; stainless steel, stainless steel / glass, plastic, clear  
Wandleuchte; Edelstahl, edelstahl / Glas, Kunststoff, klar  
Applique; acier inoxydable, acier inoxydable / verre, plastique, transparent

L 105, H 410, A 175



GU10



1x 2,8W



warm WHITE

1x 250lm



LED

1x 3,7W



warm WHITE

330lm



IP44



9 002759 941284



### 94779 BOSARO

wall light; stainless steel, stainless steel  
Wandleuchte; Edelstahl, edelstahl  
Applique; acier inoxydable, acier inoxydable

L 170, H 270, A 105



LED

2x 2,5W



warm WHITE

460lm



IP44



9 002759 947798

### 94799 BEVERLY 1

wall light; stainless steel, stainless steel / plastic, white, clear  
Wandleuchte; Edelstahl, edelstahl / Kunststoff, weiss, klar  
Applique; acier inoxydable, acier inoxydable / plastique, blanc, transparent

L 200, H 270, A 130



LED

2x 3,7W



warm WHITE

660lm



IP44



9 002759 947996



### 94107 RIGA

wall light; stainless steel, stainless steel  
Wandleuchte; Edelstahl, edelstahl  
Applique; acier inoxydable, acier inoxydable

### 94106 RIGA

wall light; stainless steel, stainless steel  
Wandleuchte; Edelstahl, edelstahl  
Applique; acier inoxydable, acier inoxydable

### 94103 RIGA

wall light; zinc-plated steel, anthracite  
Wandleuchte; Stahl verzinkt, anthrazit  
Applique; acier galvanisé, gris anthracite

L 65, H 200, A 95

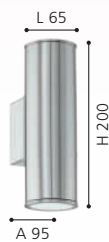

L 65, H 150, A 95



L 65, H 200, A 95

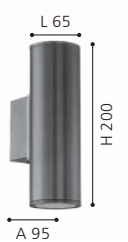
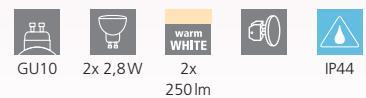



94105

LED



94101

LED



94102

LED

### 94105 RIGA

wall light; zinc-plated steel, antique-brown  
Wandleuchte; Stahl verzinkt, antik-braun  
Applique; acier galvanisé, marron antique

L 65, H 200, A 95



GU10



2x 2,8W



warm  
WHITE  
2x  
250lm



IP44



9 002759 941055



### 94102 RIGA

wall light; zinc-plated steel, anthracite  
Wandleuchte; Stahl verzinkt, anthrazit  
Applique; acier galvanisé, gris anthracite

L 65, H 150, A 95



GU10



1x 2,8W



warm  
WHITE  
1x  
250lm



IP44



9 002759 941024



### 94101 RIGA

wall light; zinc-plated steel, white  
Wandleuchte; Stahl verzinkt, weiss  
Applique; acier galvanisé, blanc

L 65, H 200, A 95



GU10



2x 2,8W



warm  
WHITE  
2x  
250lm



IP44



9 002759 941017





92736



96505



### 92736 RIGA-LED

wall light; stainless steel, stainless steel / plastic, satiné  
Wandleuchte; Edelstahl, edelstahl / Kunststoff, satiniert  
Applique; acier inoxydable, acier inoxydable / plastique, satiné

L 65, H 205, A 95

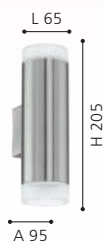
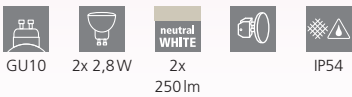

### 96505 RIGA-LED

wall light; zinc-plated steel, black / plastic, satiné  
Wandleuchte; Stahl verzinkt, schwarz / Kunststoff, satiniert  
Applique; acier galvanisé, noir / plastique, satiné

L 65, H 205, A 100



### 97119 TONEGO

wall light; zinc-plated steel, anthracite / plastic, white  
Wandleuchte; Stahl verzinkt, anthrazit / Kunststoff, weiss  
Applique; acier galvanisé, gris anthracite / plastique, blanc

L 75, H 310, A 100

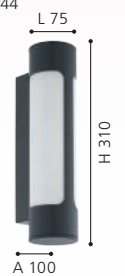



97119

LED

DESIGN  
HIGHLIGHT  
DETAIL



99569



90°, 6 m  
10 sec. - 12 min.

**SAFETY &  
COMFORT**



99571



90°, 6 m  
10 sec. - 12 min.

**SAFETY &  
COMFORT**



### 99569 RIGA 5

wall light; stainless steel, stainless steel / glass, clear  
Wandleuchte; Edelstahl, edelstahl / Glas, klar  
Applique; acier inoxydable, acier inoxydable / verre, transparent

L 65, H 165, A 110



GU10



1x 2,8W



1x  
250lm



IP44



### 99571 RIGA 5

wall light; zinc-plated steel, black / glass, clear  
Wandleuchte; Stahl verzinkt, schwarz / Glas, klar  
Applique; acier galvanisé, noir / verre, transparent

L 65, H 165, A 110



GU10



1x 2,8W



1x  
250lm



IP44





**32898**



100°, 6 m  
10 sec. - 12 min.

**SAFETY &  
COMFORT**



**32899**



100°, 6 m  
10 sec. - 12 min.

**SAFETY &  
COMFORT**

### 32898 RIGA 5

wall light; stainless steel, stainless steel / glass, clear  
Wandleuchte; Edelstahl, edelstahl / Glas, klar  
Applique; acier inoxydable, acier inoxydable / verre, transparent

L 65, H 215, A 110



GU10



2x 2,8W



2x  
250lm



IP44



9 002759 328986



### 32899 RIGA 5

wall light; zinc-plated steel, anthracite / glass, clear  
Wandleuchte; Stahl verzinkt, anthrazit / Glas, klar  
Applique; acier galvanisé, gris anthracite / verre, transparent

L 65, H 215, A 110



GU10



2x 2,8W



2x  
250lm



IP44



9 002759 328993





900291



900679



### 900291 COSTORIO

wall light; aluminium, black, brown  
Wandleuchte; Alu, schwarz, braun  
Applique; aluminium, noir, marron

L 370, B 80, H 80



11,7W



1500lm



IP44



9 008606 231638



B 80

### 900679 BITETTO

wall light; steel, brown / plastic, white  
Wandleuchte; Stahl, braun / Kunststoff, weiss  
Applique; acier, marron / plastique, blanc

L 120, H 430, A 55



7W



770lm



IP44



9 008606 261772

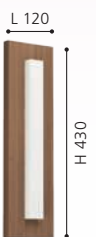

H 430





**900669**



**900671**

### 900669 BUFALATA

wall light; steel, black / plastic, white  
 Wandleuchte; Stahl, schwarz / Kunststoff, weiss  
 Applique; acier, noir / plastique, blanc

L 200, H 290, A 275



E27



1x 40W



IP44



9 008606 261758



### 900671 BUFALATA

wall light; steel, black, brown / plastic, black-transparent  
 Wandleuchte; Stahl, schwarz, braun / Kunststoff, schwarz-transparent  
 Applique; acier, noir, marron / plastique, noir transparent

L 200, H 290, A 275



E27



1x 40W



IP44



9 008606 261765





96276



90°, 6 m  
10 sec. - 12 min.

SAFETY &  
COMFORT



96277



100°, 6 m  
10 sec. - 12 min.

SAFETY &  
COMFORT

### 96276 ATOLLARI

wall light; cast aluminium, anthracite / plastic, white  
Wandleuchte; Aluguss, anthrazit / Kunststoff, weiss  
Applique; fonte d'aluminium, gris anthracite / plastique, blanc

L 100, H 230, A 155



2x 4,9W



920lm



IP44



9 002759 962760



A 155

### 96277 ATOLLARI

wall light; cast aluminium, stainless steel, silver / plastic, white  
Wandleuchte; Aluguss, edelstahl, silber / Kunststoff, weiss  
Applique; fonte d'aluminium, acier inoxydable, argent / plastique, blanc

L 100, H 230, A 155



2x 4,9W



920lm



IP44



9 002759 962777

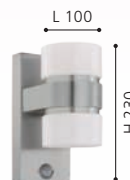

A 155



**900284**



**98086**



**98085**

### 900284 CISTIerna 2

wall light; steel, black / plastic, white  
Wandleuchte; Stahl, schwarz / Kunststoff, weiss  
Applique; acier, noir / plastique, blanc

L 130, H 350



E27 2x 10W IP44



9 008606 231546



### 98086 CISTIerna

wall light; zinc-plated steel, anthracite / plastic, white  
Wandleuchte; Stahl verzinkt, anthrazit / Kunststoff, weiss  
Applique; acier galvanisé, gris anthracite / plastique, blanc

L 180, H 350, A 90



E27 2x 10W IP44



9 002759 980863



### 98085 CISTIerna

wall light; stainless steel, stainless steel / plastic, white  
Wandleuchte; Edelstahl, edelstahl / Kunststoff, weiss  
Applique; acier inoxydable, acier inoxydable / plastique, blanc

L 180, H 350, A 90



E27 2x 10W IP44



9 002759 980856





96021



90°, 6 m  
10 sec. - 10 min.

**SAFETY &  
COMFORT**



98747



### 96021 SESIMBA 1

wall light; zinc-plated steel, black / plastic, clear  
Wandleuchte; Stahl verzinkt, schwarz / Kunststoff, klar  
Applique; acier galvanisé, noir / plastique, transparent

L 130, H 195, A 140



2x 3,7W



660lm



IP44



9 002759 960216



### 98747 TREVILO

wall light; cast aluminium, white / glass, clear  
Wandleuchte; Aluguss, weiss / Glas, klar  
Applique; fonte d'aluminium, blanc / verre, transparent

L 90, H 85, A 120



2x 2,2W



460lm



IP44



9 002759 987473



### 98746 TREVILO

wall light; cast aluminium, anthracite / glass, clear  
Wandleuchte; Aluguss, anthrazit / Glas, klar  
Applique; fonte d'aluminium, gris anthracite / verre, transparent

L 90, H 85, A 120



2x 2,2W



460lm



IP44



9 002759 987466





98746

LED



900189



900276



900275



### 900189 EREMITANA

wall light; zinc-plated steel, black  
Wandleuchte; Stahl verzinkt, schwarz  
Applique; acier galvanisé, noir

L 110, H 240, A 110

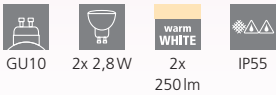

### 900275 JABAGA

wall light; plastic, black / plastic, transparent  
Wandleuchte; Kunststoff, schwarz / Kunststoff, transparent  
Applique; plastique, noir / plastique, transparent

L 70, H 80, A 90



### 900276 JABAGA

wall light; plastic, black / plastic, transparent  
Wandleuchte; Kunststoff, schwarz / Kunststoff, transparent  
Applique; plastique, noir / plastique, transparent

L 70, H 155, A 90





900292



## 900292 LESMO

wall light; cast aluminium, black / glass, clear

Wandleuchte; Aluguss, schwarz / Glas, klar

Applique; fonte d'aluminium, noir / verre, transparent

L 240, H 105, A 115



4x 2,2W



600lm



IP44



9 008606 231560

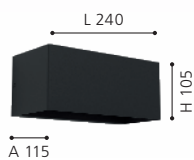



900885



900886



900887



### 900885 SPONGANO

wall light; aluminium, black / glass, clear  
Wandleuchte; Alu, schwarz / Glas, klar  
Applique; aluminium, noir / verre, transparent

L 185, H 90, A 75



2x 5W



1200lm



IP65



9 008606 263981



### 900886 SPONGANO

wall light; aluminium, black / plastic, transparent  
Wandleuchte; Alu, schwarz / Kunststoff, transparent  
Applique; aluminium, noir / plastique, transparent

L 120, H 200, A 60



2x 5W



1200lm



IP65



9 008606 263998



### 900887 SPONGANO

wall light; aluminium, black / plastic, transparent  
Wandleuchte; Alu, schwarz / Kunststoff, transparent  
Applique; aluminium, noir / plastique, transparent

L 200, H 120, A 60



1x 9,5W



1100lm



IP65



9 008606 264001

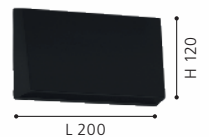





900888



900889



900891



### MARUGGIO

These luminaires can be set via step dimming change the light settings from 3000K, 4000K, 5000K to 6500 Kelvin.

Diese Leuchten können über Stepdimming die Lichteinstellungen von 3000K, 4000K, 5000K zu 6500 Kelvin wechseln.

Ces luminaires peuvent être commandés par stepdimming les réglages de lumière de 3000K, 4000K, 5000K à 6500 Kelvin.

### 900888 MARUGGIO

wall light; aluminium, black / plastic, transparent  
Wandleuchte; Alu, schwarz / Kunststoff, transparent  
Applique; aluminium, noir / plastique, transparent

Ø 150, A 35

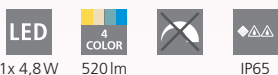

1x 4,8W 520lm

### 900889 MARUGGIO

wall light; aluminium, black / plastic, transparent  
Wandleuchte; Alu, schwarz / Kunststoff, transparent  
Applique; aluminium, noir / plastique, transparent

L 150, H 150, A 35



1x 4,8W 520lm

### 900891 MARUGGIO

wall light; aluminium, black / plastic, transparent  
Wandleuchte; Alu, schwarz / Kunststoff, transparent  
Applique; aluminium, noir / plastique, transparent

L 200, H 90, A 35



1x 4,8W 520lm



9 008606 264018



Ø 150



9 008606 264025



L 150

H 150



9 008606 264032



L 200

H 90

900445

This wall lamp creates beautiful stripe pattern on the wall.

Diese Wandleuchte kreiert schöne Streifen an der Wand.

Cette applique crée un beau motif à rayures sur le mur.

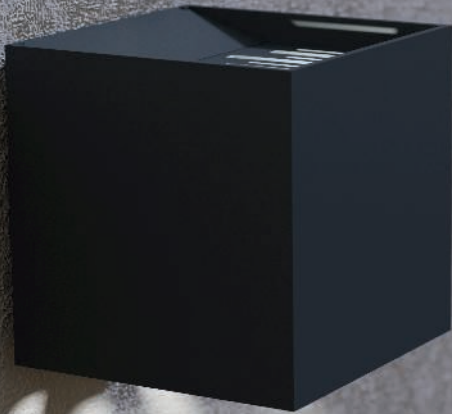

900445



97241



97242



### 900445 CALPINO 2

wall light; cast aluminium, anthracite  
Wandleuchte; Aluguss, anthrazit  
Applique; fonte d'aluminium, gris anthracite

### 97241 CALPINO

wall light; cast aluminium, white  
Wandleuchte; Aluguss, weiss  
Applique; fonte d'aluminium, blanc

### 97242 CALPINO

wall light; cast aluminium, anthracite  
Wandleuchte; Aluguss, anthrazit  
Applique; fonte d'aluminium, gris anthracite

L 105, H 105, A 110



2x 3,3W 680lm

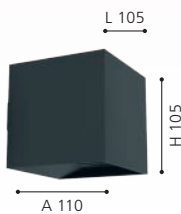

L 105, H 105, A 110



2x 3,3W 680lm

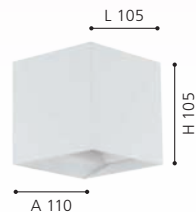

L 105, H 105, A 110



2x 3,3W 680lm

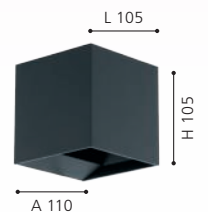



96256

LED



96287

LED



100°, 6 m  
10 sec. - 12 min.

SAFETY &  
COMFORT



95097

LED



### 96256 JORBA

wall light; cast aluminium, anthracite / plastic, white  
Wandleuchte; Aluguss, anthrazit / Kunststoff, weiss  
Applique; fonte d'aluminium, gris anthracite / plastique, blanc

L 110, H 110, A 110



1x 4,9W



360lm



IP44



9 002759 962562

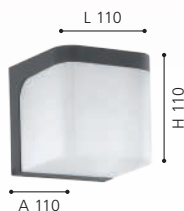

### 95097 DESELLA 1

wall light; cast aluminium, anthracite / plastic, white  
Wandleuchte; Aluguss, anthrazit / Kunststoff, weiss  
Applique; fonte d'aluminium, gris anthracite / plastique, blanc

L 160, H 160, A 190



10W



1200lm



IP55



9 002759 950972



### 96287 SAKEDA

wall light; cast aluminium, anthracite  
Wandleuchte; Aluguss, anthrazit  
Applique; fonte d'aluminium, gris anthracite

L 70, H 170, A 100



1x 5W



600lm



IP44



9 002759 962876





900807



900809

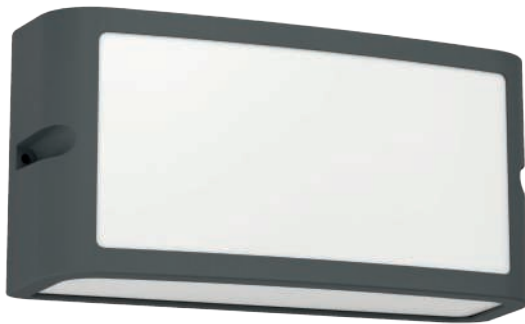

900808



### 900807 CAMARDA

wall light; aluminium, white / plastic, white  
Wandleuchte; Alu, weiss / Kunststoff, weiss  
Applique; aluminium, blanc / plastique, blanc

L 220, H 110, A 90



10,5W



1200lm



IP54

### 900808 CAMARDA

wall light; aluminium, anthracite / plastic, white  
Wandleuchte; Alu, anthrazit / Kunststoff, weiss  
Applique; aluminium, gris anthracite / plastique, blanc

L 220, H 110, A 90



10,5W



1200lm



IP54

### 900809 CAMARDA

wall light; aluminium, white / plastic, white  
Wandleuchte; Alu, weiss / Kunststoff, weiss  
Applique; aluminium, blanc / plastique, blanc

L 220, H 110, A 90



E27



1x 40W



IP54



9 008606 261895

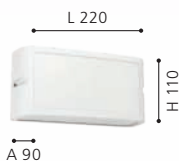

9 008606 261901



9 008606 261918

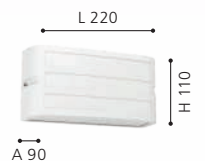



900811



### 900811 CAMARDA

wall light; aluminium, anthracite / plastic, white

Wandleuchte; Alu, anthrazit / Kunststoff, weiss

Applique; aluminium, gris anthracite / plastique, blanc

L 220, H 110, A 90



E27



1x 40 W



IP54



9 008606 261925

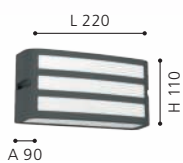

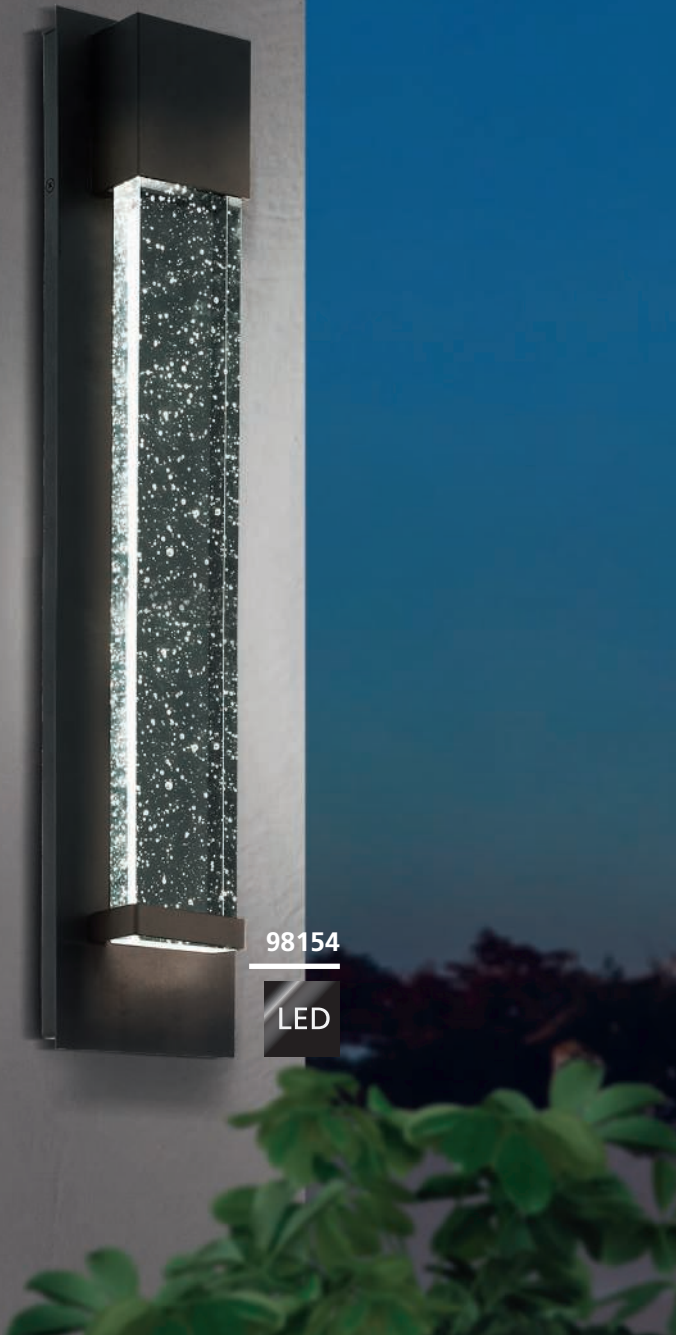

98154

LED



98153

LED

### 98154 VILLAGRAZIA

wall light; aluminium, black / glass with air inclusions, clear  
 Wandleuchte; Alu, schwarz / Glas mit Lufteinschlüssen, klar  
 Applique; aluminium, noir / verre avec inclusions d'air, transparent

L 120, H 400, A 70



2x 3,3W 680lm



9 002759 981549

### 98153 VILLAGRAZIA

wall light; aluminium, black / glass with air inclusions, clear  
 Wandleuchte; Alu, schwarz / Glas mit Lufteinschlüssen, klar  
 Applique; aluminium, noir / verre avec inclusions d'air, transparent

L 120, H 300, A 70



2x 3,3W 680lm



9 002759 981532



98709



98729



98711



### 98709 CHINOA

wall light; aluminium, steel, white / plastic, transparent  
Wandleuchte; Alu, Stahl, weiss / Kunststoff, transparent  
Applique; aluminium, acier, blanc / plastique, transparent

L 270, H 75, A 135



### 98711 CHINOA

wall light; aluminium, steel, anthracite / plastic, transparent  
Wandleuchte; Alu, Stahl, anthrazit / Kunststoff, transparent  
Applique; aluminium, acier, gris anthracite / plastique, transparent

L 270, H 75, A 135



### 98729 PASSIRANO

wall light; cast aluminium, black, white / plastic, transparent  
Wandleuchte; Aluguss, schwarz, weiss / Kunststoff, transparent  
Applique; fonte d'aluminium, noir, blanc / plastique, transparent

L 240, H 120, A 110

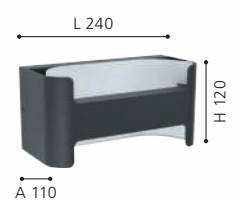



**97218**



180°, 7 m  
10 sec. - 15 min.

**SAFETY & COMFORT**



**97238**



90°, 7 m  
10 sec. - 4 min.

**SAFETY & COMFORT**

### 97218 MUSSOTTO

wall light; stainless steel, plastic, stainless steel, white / plastic, white

Wandleuchte; Edelstahl, Kunststoff, edelstahl, weiss / Kunststoff, weiss

Applique; acier inoxydable, plastique, acier inoxydable, blanc / plastique, blanc

L 210, H 305, A 90



E27



1x 28W



IP44



L 210



A 90



9 002759 972189

### 97238 VERRES

wall light; stainless steel, plastic, stainless steel, white / plastic, white

Wandleuchte; Edelstahl, Kunststoff, edelstahl, weiss / Kunststoff, weiss

Applique; acier inoxydable, plastique, acier inoxydable, blanc / plastique, blanc

L 180, H 290, A 90



E27



1x 12W



IP44



L 180



A 90



9 002759 972387

### 83433 PARK

wall light; cast aluminium, anthracite / satin glass, white

Wandleuchte; Aluguss, anthrazit / Glas satiniert, weiss

Applique; fonte d'aluminium, gris anthracite / verre satiné, blanc

L 200, H 350, A 145



E27



1x 60W



IP44

L 200



9 002759 834333



A 145





83433



96018



90°, 6 m  
10 sec. - 10 min.

**SAFETY &  
COMFORT**



94138



97284



180°, 6 m  
10 sec. - 15 min.

**SAFETY & COMFORT**

### 96018 BREGANZO 1

wall light; zinc-plated steel, anthracite / plastic, white  
Wandleuchte; Stahl verzinkt, anthrazit / Kunststoff, weiss  
Applique; acier galvanisé, gris anthracite / plastique, blanc

L 190, H 300, A 125



2x 2,5W



460lm



IP44



9 002759 960186

### 94138 BREGANZO

wall light; zinc-plated steel, anthracite / plastic, white  
Wandleuchte; Stahl verzinkt, anthrazit / Kunststoff, weiss  
Applique; acier galvanisé, gris anthracite / plastique, blanc

L 180, H 250, A 115



2x 2,5W 460lm



460lm



IP44



9 002759 941383

### 97284 TRIBANO

wall light; zinc-plated steel, stainless steel / plastic, transparent  
Wandleuchte; Stahl verzinkt, edelstahl / Kunststoff, transparent  
Applique; acier galvanisé, acier inoxydable / plastique, transparent

L 200, H 260, A 100



E27



1x 60W



IP44



9 002759 972844





30191



30192



90°, 7 m  
10 sec. - 4 min.

SAFETY &  
COMFORT

### 30191 CERNO

wall light; stainless steel, stainless steel / satin glass, white  
Wandleuchte; Edelstahl, edelstahl / Glas satiniert, weiss  
Applique; acier inoxydable, acier inoxydable / verre satiné, blanc

L 140, H 165, A 105



E27



1x 40W



IP44



9 002759 301910



### 30192 CERNO

wall light; stainless steel, stainless steel / satin glass, white  
Wandleuchte; Edelstahl, edelstahl / Glas satiniert, weiss  
Applique; acier inoxydable, acier inoxydable / verre satiné, blanc

L 140, H 190, A 110



E27



1x 40W



IP44



9 002759 301927





99565



99566



90°, 6 m  
5 sec. - 5 min.

**SAFETY &  
COMFORT**

### 99565 CERNO

wall light; zinc-plated steel, black / satin glass, white  
Wandleuchte; Stahl verzinkt, schwarz / Glas satiniert, weiss  
Applique; acier galvanisé, noir / verre satiné, blanc

L 140, H 165, A 105



E27



1x 40W



IP44



9 002759 995652



### 99566 CERNO

wall light; zinc-plated steel, black / satin glass, white  
Wandleuchte; Stahl verzinkt, schwarz / Glas satiniert, weiss  
Applique; acier galvanisé, noir / verre satiné, blanc

L 140, H 200, A 110



E27



1x 40W



IP44



9 002759 995669





88144



90°, 7 m  
10 sec. - 5 min.

**SAFETY &  
COMFORT**



82309



88142



90°, 7 m  
10 sec. - 5 min.

**SAFETY &  
COMFORT**

### 88144 CITY

wall light; stainless steel, stainless steel / plastic, white  
Wandleuchte; Edelstahl, edelstahl / Kunststoff, weiss  
Applique; acier inoxydable, acier inoxydable / plastique, blanc

L 235, H 260, A 90



E27 1x 60W

IP44



9 002759 881443

### 82309 CITY

wall light; stainless steel, stainless steel / plastic, white  
Wandleuchte; Edelstahl, edelstahl / Kunststoff, weiss  
Applique; acier inoxydable, acier inoxydable / plastique, blanc

L 235, H 260, A 90



E27 1x 60W

IP44



9 002759 823092

### 88142 CITY

wall light; stainless steel, stainless steel / plastic, white  
Wandleuchte; Edelstahl, edelstahl / Kunststoff, weiss  
Applique; acier inoxydable, acier inoxydable / plastique, blanc

L 235, H 260, A 90



E27 1x 60W

IP44

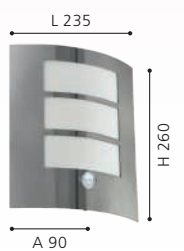

9 002759 881429



99568



90°, 7 m  
10 sec. - 5 min.

**SAFETY &  
COMFORT**



88139



99567

### 88139 CITY

wall light; stainless steel, stainless steel / plastic, white  
Wandleuchte; Edelstahl, edelstahl / Kunststoff, weiss  
Applique; acier inoxydable, acier inoxydable / plastique, blanc

L 235, H 260, A 90



E27



1x 60W



IP44



9 002759 881399

### 99567 CITY

wall light; zinc-plated steel, black / plastic, white  
Wandleuchte; Stahl verzinkt, schwarz / Kunststoff, weiss  
Applique; acier galvanisé, noir / plastique, blanc

L 235, H 260, A 90



E27



1x 40W



IP44



9 002759 995676

### 99568 CITY

wall light; zinc-plated steel, black / plastic, white  
Wandleuchte; Stahl verzinkt, schwarz / Kunststoff, weiss  
Applique; acier galvanisé, noir / plastique, blanc

L 235, H 260, A 110



E27



1x 40W



90°, 7 m



IP44



9 002759 995683





97312



120°, 6 m  
10 sec. - 8 min.

**SAFETY &  
COMFORT**



89767

### 97312 BELCREDA

wall light; cast aluminium, anthracite / plastic, white  
Wandleuchte; Aluguss, anthrazit / Kunststoff, weiss  
Applique; fonte d'aluminium, gris anthracite / plastique, blanc

### 89767 ONJA

wall light; cast aluminium, black / glass fluted, clear  
Wandleuchte; Aluguss, schwarz / Glas geriffelt, klar  
Applique; fonte d'aluminium, noir / verre cannelé, transparent

### 89768 ONJA

wall light; cast aluminium, white / glass fluted, clear  
Wandleuchte; Aluguss, weiss / Glas geriffelt, klar  
Applique; fonte d'aluminium, blanc / verre cannelé, transparent

L 330, H 125, A 165



9W 1200lm



IP44



9 002759 973124



L 220, H 155, A 150



E27 1x 40W IP44



9 002759 897673



L 220, H 155, A 150



E27 1x 40W IP44



9 002759 897680





**89767, 89768**

With direct and indirect light this luminaire creates a spectacular effect.

Diese Leuchten schaffen durch direktes und indirektes Licht einen tollen Effekt.

Ce luminaire crée un effet lumineux special pour une illumination directe et indirecte.



**89768**

# CLASSIC

KLASSIK  
CLASSIQUE

## TIMELESS CLASSICS

Romantic and nostalgic elements from different materials create unique luminaires for your outdoor area. True classics for a real wellness ambience.

## ZEITLOSE KLASSIKER

Romantische und nostalgische Elemente aus unterschiedlichen Materialien kreieren einzigartige Leuchten für Ihren Außenbereich. Wahre Klassiker für echtes Wohlfühlambiente.

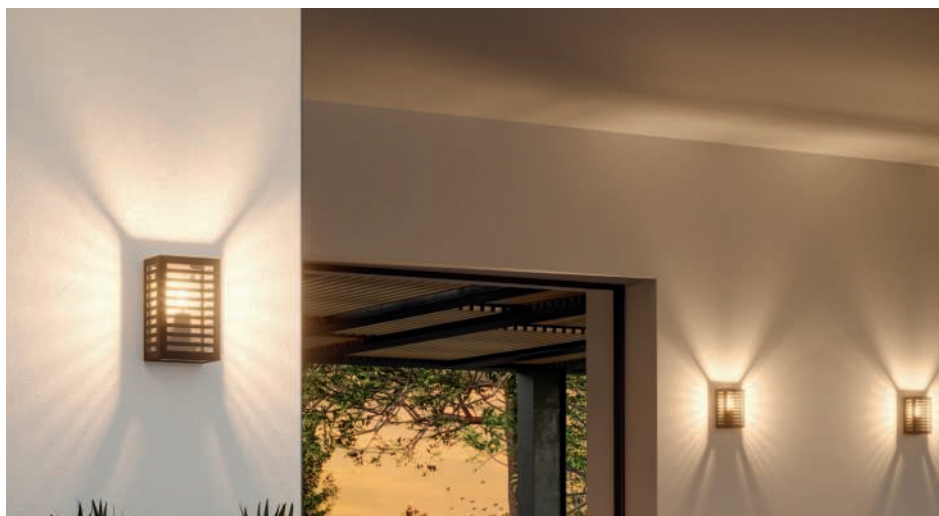

































## CLASSIQUE INTEMPOREL

Des éléments romantiques et nostalgiques issus de différents matériaux forment d' uniques luminaires pour votre extérieur. De véritables classiques pour une vraie ambiance de bien-être.



# OVERVIEW

## CLASSIC

 CARRARO 124	 CHIAPPERA 125	 BUDRONE 127	 ALAMONTE 3 128-129	 ALAMONTE 130,135	 ALAMONTE 1 130-132	 CASCINETTA 132-133	 SONCINO 135
 MIRANDOLA 135	 RAVELLO 136-137	 SELINUS 137	 SIRMIONE 138	 SIDNEY 139	 LISIO 140-141	 TAVERNA 142	 VALDEO 144,152
 BOVOLONE 144	 TRECATE 144	 MONREALE 145	 MELGOA 146,150	 CANOVE 146	 PULFERO 146	 BARROSELA 147,150	 ENTRIMO 147
 HILBURN 148	 HILBURN 1 148	 MILTON 149-150	 PULFERO 1 152	 ALBACETE 152	 SAN TELMO 153	 ALORIA 154-156	 NAVEDO 158-163
 LATERNA 4 164-165,168	 LATERNA 5 166,169						



This product is available in different colors and shapes./ Dieser Artikel ist in unterschiedlichen Farben und Formen verfügbar.  
Cet article est disponible en différentes couleurs et formes.



900285



900286

DESIGN  
HIGHLIGHT  
DETAIL



### 900285 CARRARO

wall light; steel, black / glass, clear  
Wandleuchte; Stahl, schwarz / Glas, klar  
Applique; acier, noir / verre, transparent

L 115, H 380, A 130



E27



1x 28W



IP44



9 008606 231577



A 130

### 900286 CARRARO

wall light; steel, grey, black / glass, clear  
Wandleuchte; Stahl, grau, schwarz / Glas, klar  
Applique; acier, gris, noir / verre, transparent

L 115, H 380, A 130



E27



1x 28W



IP44



9 008606 231584



A 130



900287



900802



900803



### 900287 CHIAPPERA

wall light; steel, black, white / glass, clear  
Wandleuchte; Stahl, schwarz, weiss / Glas, klar  
Applique; acier, noir, blanc / verre, transparent

L 220, H 225, A 245



E27



1x 40W



IP44



9 008606 231645

### 900802 CHIAPPERA

pedestal light; steel, black, white / glass, clear  
Sockelleuchte; Stahl, schwarz, weiss / Glas, klar  
luminaire pour socle; acier, noir, blanc / verre, transparent

H 330, Ø 220



E27



1x 40W



IP65



9 008606 261819

### 900803 CHIAPPERA

path light; steel, black, white / glass, clear  
Wegeleuchte; Stahl, schwarz, weiss / Glas, klar  
Éclairage du chemin; acier, noir, blanc / verre, transparent

H 800, Ø 220



E27



1x 40W



IP65



9 008606 261826



900289



900288, 900289

This luminaires can be mounted upwards or downwards.

Diese Leuchten können aufwärts oder abwärts montiert werden.

Ces luminaires peut être montée vers le haut ou vers le bas.



900288



### 900289 BUDRONE

wall light; steel, black, brown / glass, clear  
Wandleuchte; Stahl, schwarz, braun / Glas, klar  
Applique; acier, noir, marron / verre, transparent

L 120, H 270, A 165



E27



1x 40W



IP44



9 008606 231591

### 900288 BUDRONE

wall light; steel, black / glass, clear  
Wandleuchte; Stahl, schwarz / Glas, klar  
Applique; acier, noir / verre, transparent

L 120, H 270, A 165



E27



1x 40W



IP44



9 008606 231607



**900137**



90°, 6 m  
10 sec. - 12 min.

**SAFETY &  
COMFORT**



**900138**

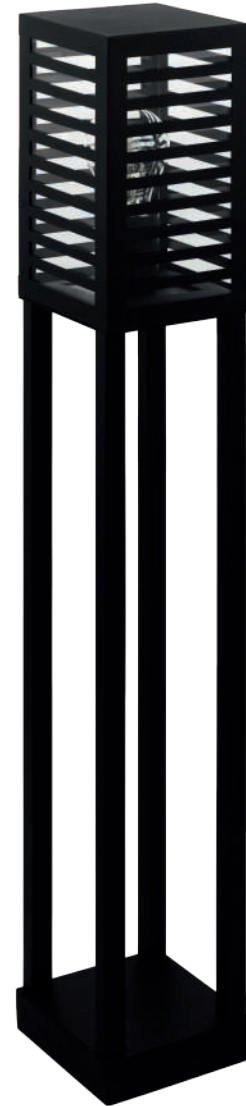

**900139**

**900137 ALAMONTE 3**

wall light; aluminium, steel, black  
Wandleuchte; Alu, Stahl, schwarz  
Applique; aluminium, acier, noir

L 170, H 295, A 100



**900138 ALAMONTE 3**

pedestal light; aluminium, steel, black  
Sockelleuchte; Alu, Stahl, schwarz  
luminaire pour socle; aluminium, acier, noir

L 150, B 150, H 450

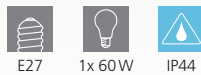

**900139 ALAMONTE 3**

floor light; aluminium, steel, black  
Stehleuchte; Alu, Stahl, schwarz  
lampadaire; aluminium, acier, noir

L 150, B 150, H 1000





900136

### 900136 ALAMONTE 3

wall light; aluminium, steel, black  
Wandleuchte; Alu, Stahl, schwarz  
Applique; aluminium, acier, noir

L 170, H 260, A 100



E27



1x 60W



IP44

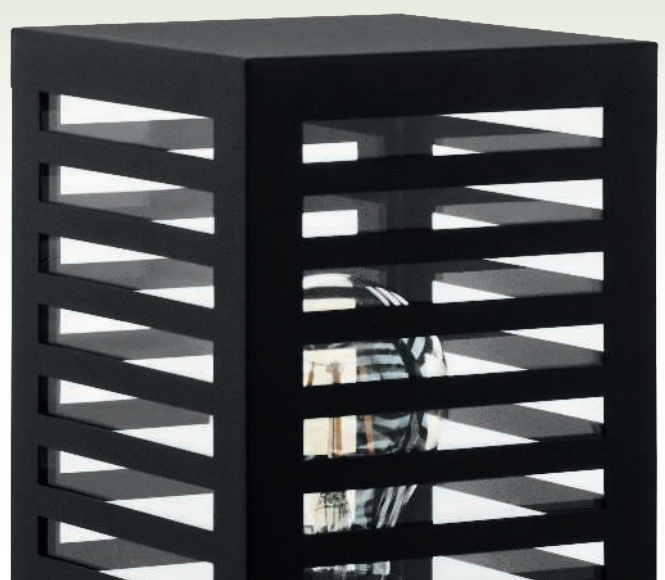

9 008606 230105





99587



98273



94831

### 99587 ALAMONTE

wall light; steel, black / glass, clear  
Wandleuchte; Stahl, schwarz / Glas, klar  
Applique; acier, noir / verre, transparent

L 170, H 295, A 115

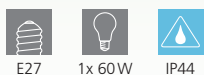

E27 1x 60W IP44



9 002759 995874



### 98273 ALAMONTE 1

wall light; steel, black / glass, clear  
Wandleuchte; Stahl, schwarz / Glas, klar  
Applique; acier, noir / verre, transparent

L 150, H 380, A 100



E27 2x 60W IP44



9 002759 982737



### 94831 ALAMONTE 1

wall light; steel, black / glass, clear  
Wandleuchte; Stahl, schwarz / Glas, klar  
Applique; acier, noir / verre, transparent

L 170, H 260, A 100

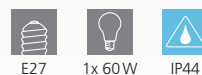

E27 1x 60W IP44



9 002759 948313





900698



94832

### 900698 ALAMONTE 1

wall light; steel, black / glass, clear  
Wandleuchte; Stahl, schwarz / Glas, klar  
Applique; acier, noir / verre, transparent

L 290, H 260, A 100



E27



2x 40 W



IP44



9 008606 255917



A 100

### 94832 ALAMONTE 1

wall / ceiling light; steel, black / glass, clear  
Wand- / Deckenleuchte; Stahl, schwarz / Glas, klar  
Applique/Plafonnier; acier, noir / verre, transparent

L 290, H 290, A 130



E27



2x 28 W



IP44



9 002759 948320



L 290

### 94832

This luminaire can be mounted as a wall or ceiling luminaire.

Diese Leuchte kann als Wand- oder Deckenleuchte montiert werden.

Ce luminaire peut être monté en tant qu'applique murale ou plafonnier.



94788



94833



98713



### 94788 ALAMONTE 1

pendant light; steel, black / glass, clear  
 Hängeleuchte; Stahl, schwarz / Glas, klar  
 luminaire en suspension; acier, noir / verre, transparent

L 150, B 150, H 1285



9 002759 947880



### 94833 ALAMONTE 1

floor light; steel, black / glass, clear  
 Stehleuchte; Stahl, schwarz / Glas, klar  
 lampadaire; acier, noir / verre, transparent

L 150, B 150, H 1015, Base: Ø 110



9 002759 948337



### 98713 CASCINETTA

wall light; zinc-plated steel, black / glass, clear  
 Wandleuchte; Stahl verzinkt, schwarz / Glas, klar  
 Applique; acier galvanisé, noir / verre, transparent

L 165, H 280, A 165



9 002759 987138





98715



98714



### 98714 CASCINETTA

pedestal light; cast aluminium, black / glass, clear  
 Sockelleuchte; Aluguss, schwarz / Glas, klar  
 luminaire pour socle; fonte d'aluminium, noir / verre, transparent

L 150, B 150, H 305



E27



1x 40W



IP54



L 150

### 98715 CASCINETTA

floor light; cast aluminium, black / glass, clear  
 Stehleuchte; Aluguss, schwarz / Glas, klar  
 lampadaire; fonte d'aluminium, noir / verre, transparent

L 150, B 150, H 795



E27



1x 40W



IP54



L 150



9 002759 987145



9 002759 987152



**97294**





98719



94827

### 97294 SONCINO

wall light; cast aluminium, black / glass, clear  
Wandleuchte; Aluguss, schwarz / Glas, klar  
Applique; fonte d'aluminium, noir / verre, transparent

L 265, H 330, A 120



E27



2x 60 W



IP44



9 002759 972943



### 98719 MIRANDOLA

wall light; cast aluminium, black / glass, clear  
Wandleuchte; Aluguss, schwarz / Glas, klar  
Applique; fonte d'aluminium, noir / verre, transparent

L 180, H 270, A 225



E27



1x 60 W



IP44



9 002759 987190



### 94827 ALAMONTE

wall light; stainless steel, stainless steel / glass, clear  
Wandleuchte; Edelstahl, edelstahl / Glas, klar  
Applique; acier inoxydable, acier inoxydable / verre, transparent

L 170, H 260, A 100



E27



1x 60 W



IP44



9 002759 948276

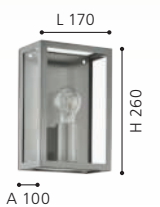



98721



98722



90°, 6 m  
10 sec. - 12 min.

**SAFETY &  
COMFORT**



98723



### 98722 RAVELLO

wall light; zinc-plated steel, black / plastic, white  
Wandleuchte; Stahl verzinkt, schwarz / Kunststoff, weiss  
Applique; acier galvanisé, noir / plastique, blanc

L 165, H 320, A 225

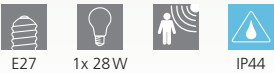

### 98721 RAVELLO

wall light; zinc-plated steel, black / plastic, white  
Wandleuchte; Stahl verzinkt, schwarz / Kunststoff, weiss  
Applique; acier galvanisé, noir / plastique, blanc

L 165, H 275, A 225



### 98723 RAVELLO

pedestal light; zinc-plated steel, black / plastic, white  
Sockelleuchte; Stahl verzinkt, schwarz / Kunststoff, weiss  
luminaire pour socle; acier galvanisé, noir / plastique, blanc

H 450, Ø 165, Base: Ø 115





98724



900672



900684



### 98724 RAVELLO

floor light; zinc-plated steel, black / plastic, white  
 Stehleuchte; Stahl verzinkt, schwarz / Kunststoff, weiss  
 lampadaire; acier galvanisé, noir / plastique, blanc

H 1100, Ø 165, Base: Ø 115



9 002759 987244

### 900672 SELINUS

wall light; steel, black / glass, clear  
 Wandleuchte; Stahl, schwarz / Glas, klar  
 Applique; acier, noir / verre, transparent

L 190, H 220, A 220

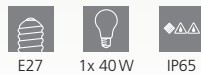

9 008606 261680

### 900684 SELINUS

floor light; steel, black / glass, clear  
 Stehleuchte; Stahl, schwarz / Glas, klar  
 lampadaire; acier, noir / verre, transparent

L 290, B 190, H 845, Base: Ø 140

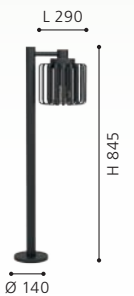

9 008606 261697



97285

97287



97288

### 97285 SIRMIONE

wall light; zinc-plated steel, black, gold / glass opal-matt, white  
Wandleuchte; Stahl verzinkt, schwarz, gold / Glas opal-matt, weiss  
Applique; acier galvanisé, noir, or / verre opale mat, blanc

L 270, H 375, A 330



E27 1x 60W IP44



9 002759 972851

### 97287 SIRMIONE

floor light; zinc-plated steel, black, gold / glass opal-matt, white  
Stehleuchte; Stahl verzinkt, schwarz, gold / Glas opal-matt, weiss  
lampadaire; acier galvanisé, noir, or / verre opale mat, blanc

L 340, B 270, H 1200, Base: Ø 110

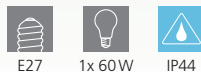

E27 1x 60W IP44

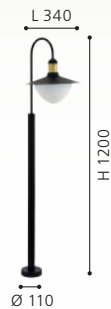

9 002759 972875

### 97288 SIRMIONE

floor light; zinc-plated steel, black, gold / glass opal-matt, white  
Stehleuchte; Stahl verzinkt, schwarz, gold / Glas opal-matt, weiss  
lampadaire; acier galvanisé, noir, or / verre opale mat, blanc

H 2200, Ø 550, Base: Ø 200



E27 3x 60W IP44

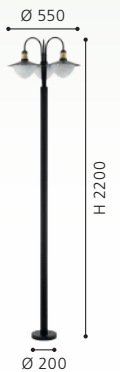

9 002759 972882



**83966**



**87105**



120°, 6 m  
5 sec. - 8 min.

**SAFETY &  
COMFORT**



**83971**

### 83966 SIDNEY

wall light; stainless steel, stainless steel / glass opal-matt, white  
Wandleuchte; Edelstahl, edelstahl / Glas opal-matt, weiss  
Applique; acier inoxydable, acier inoxydable / verre opale mat, blanc

H 375, Ø 270, A 325



E27



1x 60 W



IP44



9 002759 839666

### 87105 SIDNEY

wall light; stainless steel, stainless steel / glass opal-matt, white  
Wandleuchte; Edelstahl, edelstahl / Glas opal-matt, weiss  
Applique; acier inoxydable, acier inoxydable / verre opale mat, blanc

H 375, Ø 270, A 325



E27



1x 60 W



IP44



9 002759 871055



### 83971 SIDNEY

floor light; stainless steel, stainless steel / glass opal-matt, white  
Stehleuchte; Edelstahl, edelstahl / Glas opal-matt, weiss  
lampadaire; acier inoxydable, acier inoxydable / verre opale mat, blanc

H 2200, Ø 600, Base: Ø 200



E27



3x 60 W



IP44



9 002759 839710

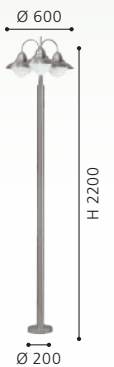



30184



30185



90°, 8 m  
10 sec. - 4 min.

**SAFETY & COMFORT**

### 30184 LISIO

wall light; stainless steel, stainless steel / glass, clear  
Wandleuchte; Edelstahl, edelstahl / Glas, klar  
Applique; acier inoxydable, acier inoxydable / verre, transparent

L 175, H 300, A 225

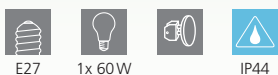

9 002759 301842



### 30185 LISIO

wall light; stainless steel, stainless steel / glass, clear  
Wandleuchte; Edelstahl, edelstahl / Glas, klar  
Applique; acier inoxydable, acier inoxydable / verre, transparent

L 175, H 360, A 225



9 002759 301859



### 30188 LISIO

floor light; stainless steel, stainless steel / glass, clear  
Stehleuchte; Edelstahl, edelstahl / Glas, klar  
lampadaire; acier inoxydable, acier inoxydable / verre, transparent

H 1000, Ø 175, Base: Ø 130

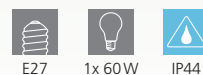

9 002759 301880

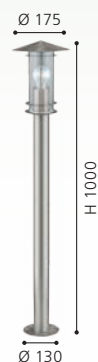



30188

### 30187 LISIO

floor light; stainless steel, stainless steel / glass, clear  
Stehleuchte; Edelstahl, edelstahl / Glas, klar  
lampadaire; acier inoxydable, acier inoxydable / verre, transparent

H 500, Ø 175, Base: Ø 130



E27



1x 60 W



IP44



9 002759 301873

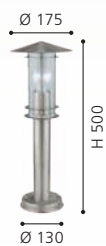

30187



99586

## 99586 & 99598

This luminaire can be mounted upwards or downwards.

Diese Leuchten können aufwärts oder abwärts montiert werden.

Ces luminaires peut être montée vers le haut ou vers le bas.



1



2

### 99586 TAVERNA

wall light; zinc-plated steel, black / plastic, black-transparent  
Wandleuchte; Stahl verzinkt, schwarz / Kunststoff, schwarz-transparent  
Applique; acier galvanisé, noir / plastique, noir transparent

L 200, H 230, A 255



E27



1x 28W



IP44



9 002759 995867



### 99598 TAVERNA

wall light; zinc-plated steel, black / plastic, transparent  
Wandleuchte; Stahl verzinkt, schwarz / Kunststoff, transparent  
Applique; acier galvanisé, noir / plastique, transparent

L 200, H 230, A 270



E27



1x 28W



IP44



9 002759 995980







99598



97261



97296



96239

### 97261 BOVOLONE

wall light; zinc-plated steel, black / glass, clear  
Wandleuchte; Stahl verzinkt, schwarz / Glas, klar  
Applique; acier galvanisé, noir / verre, transparent

### 96239 VALDEO

wall light; zinc-plated steel, black / glass, clear  
Wandleuchte; Stahl verzinkt, schwarz / Glas, klar  
Applique; acier galvanisé, noir / verre, transparent

### 97296 TRECATE

wall light; zinc-plated steel, black / glass, clear  
Wandleuchte; Stahl verzinkt, schwarz / Glas, klar  
Applique; acier galvanisé, noir / verre, transparent

L 110, H 340, A 155



L 165, H 275, A 200

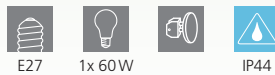

L 160, H 355, A 130

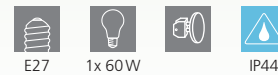



98121



98123

### 98121 MONREALE

wall light; cast aluminium, black / plastic, transparent  
 Wandleuchte; Aluguss, schwarz / Kunststoff, transparent  
 Applique; fonte d'aluminium, noir / plastique, transparent

L 230, H 275, A 255



E27



1x 60 W



IP44



9 002759 981211

### 98123 MONREALE

floor light; cast aluminium, black / plastic, transparent  
 Stehleuchte; Aluguss, schwarz / Kunststoff, transparent  
 lampadaire; fonte d'aluminium, noir / plastique, transparent

H 995, Ø 230, Base: Ø 110



E27



1x 60 W



IP44



9 002759 981235





**94792**



**97226**



**94841**

### 94792 MELGOA

wall light; zinc-plated steel, black / glass, clear  
Wandleuchte; Stahl verzinkt, schwarz / Glas, klar  
Applique; acier galvanisé, noir / verre, transparent

### 97226 CANOVE

wall light; zinc-plated steel, black / glass, clear, satiné  
Wandleuchte; Stahl verzinkt, schwarz / Glas, klar, satiniert  
Applique; acier galvanisé, noir / verre, transparent, satiné

### 94841 PULFERO

wall light; zinc-plated steel, black / plastic, transparent  
Wandleuchte; Stahl verzinkt, schwarz / Kunststoff, transparent  
Applique; acier galvanisé, noir / plastique, transparent

L 300, H 250, A 380



E27

1x 60W

IP44



9 002759 947927

L 230, H 240, A 235

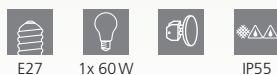

E27

1x 60W

IP55



9 002759 972264

L 220, H 280, A 280



E27

1x 60W

IP44



9 002759 948412



94805



96207

### 94805 BARROSELA

wall light; zinc-plated steel, black / plastic, white  
Wandleuchte; Stahl verzinkt, schwarz / Kunststoff, weiss  
Applique; acier galvanisé, noir / plastique, blanc

L 220, H 240, A 230



E27



1x 40 W



IP44



9 002759 948054



### 96207 ENTRIMO

wall light; zinc-plated steel, black / plastic, white  
Wandleuchte; Stahl verzinkt, schwarz / Kunststoff, weiss  
Applique; acier galvanisé, noir / plastique, blanc

L 200, H 185, A 235



E27



1x 40 W



IP44



9 002759 962074





94842



94843



94866

### 94842 HILBURN

wall light; zinc-plated steel, black / plastic, transparent  
Wandleuchte; Stahl verzinkt, schwarz / Kunststoff, transparent  
Applique; acier galvanisé, noir / plastique, transparent

L 200, H 375, A 170

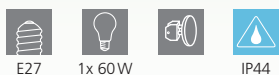

E27 1x 60W IP44



9 002759 948429



### 94843 HILBURN

wall light; zinc-plated steel, black / plastic, transparent  
Wandleuchte; Stahl verzinkt, schwarz / Kunststoff, transparent  
Applique; acier galvanisé, noir / plastique, transparent

L 200, H 280, A 200

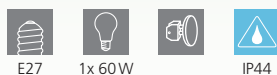

E27 1x 60W IP44



9 002759 948436



### 94866 HILBURN 1

wall light; zinc-plated steel, silver-antique / plastic, transparent  
Wandleuchte; Stahl verzinkt, silber-antik / Kunststoff, transparent  
Applique; acier galvanisé, argent antique / plastique, transparent

L 200, H 280, A 200



E27 1x 60W IP44



9 002759 948665

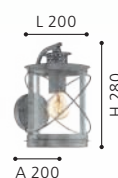



88489

### 88489 MILTON

wall light; steel, zinc-plated / glass, clear

Wandleuchte; Stahl, feuerverzinkt / Glas, klar

Applique; acier, galvanisé à chaud / verre, transparent

H 310, A 310



E27



1x 60 W



IP44



9 002759 884895

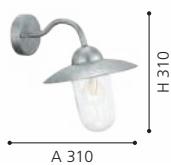



94863



94858

### 94863 MELGOA

wall light; zinc-plated steel, copper-coloured antique / glass, clear

Wandleuchte; Stahl verzinkt, kupferfarben-antik / Glas, klar  
 Applique; acier galvanisé, cuivré antique / verre, transparent

L 300, H 250, A 380



9 002759 948634



### 94858 BARROSELA

wall light; zinc-plated steel, copper-coloured antique / plastic, white

Wandleuchte; Stahl verzinkt, kupferfarben-antik / Kunststoff, weiss

Applique; acier galvanisé, cuivré antique / plastique, blanc

L 220, H 240, A 230



9 002759 948580



### 83589 MILTON

wall light; zinc-plated steel, antique-brown / glass, clear

Wandleuchte; Stahl verzinkt, antik-braun / Glas, klar

Applique; acier galvanisé, marron antique / verre, transparent

B 240, H 310, A 300

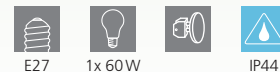

9 002759 835897

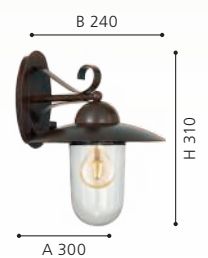





83589



94855



96241

### 94855 PULFERO 1

wall light; zinc-plated steel, brown / plastic, transparent  
Wandleuchte; Stahl verzinkt, braun / Kunststoff, transparent  
Applique; acier galvanisé, marron / plastique, transparent

L 220, H 280, A 280



### 96241 VALDEO

wall light; zinc-plated steel, copper-coloured antique / glass, clear  
Wandleuchte; Stahl verzinkt, kupferfarben-antik / Glas, klar  
Applique; acier galvanisé, cuivré antique / verre, transparent

L 165, H 275, A 200



### 96262 ALBACETE

wall light; zinc-plated steel, brown, copper / glass with air inclusions, clear  
Wandleuchte; Stahl verzinkt, braun, kupfer / Glas mit Luftinclusionen, klar  
Applique; acier galvanisé, marron, cuivre / verre avec inclusions d'air, transparent  
L 265, H 255, A 280





96262

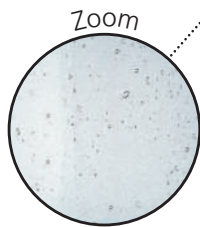

90184

### 90184 SAN TELMO

wall light; zinc-plated steel, cast alumin, antique-brown / glass with air inclusions, clear

Wandleuchte; Stahl verzinkt, Aluguss, antik-braun / Glas mit Lufteinschlüssen, klar

Applique; acier galvanisé, fonte d'alumi, marron antique / verre avec inclusions d'air, transparent

L 180, H 350, A 240



E27



1x 60 W



IP23



9 002759 901844





93097



93407



93098

### 93097 ALORIA

wall light; cast aluminium, black / plastic, clear  
Wandleuchte; Aluguss, schwarz / Kunststoff, klar  
Applique; fonte d'aluminium, noir / plastique, transparent

L 170, H 225, A 190



9 002759 930974



### 93098 ALORIA

wall light; cast aluminium, black / plastic, clear  
Wandleuchte; Aluguss, schwarz / Kunststoff, klar  
Applique; fonte d'aluminium, noir / plastique, transparent

L 170, H 225, A 190



9 002759 930981



### 93407 ALORIA

wall light; cast aluminium, black / plastic, clear  
Wandleuchte; Aluguss, schwarz / Kunststoff, klar  
Applique; fonte d'aluminium, noir / plastique, transparent

L 180, H 200, A 120



9 002759 934071





93099



93408

### 93099 ALORIA

pedestal light; cast aluminium, black / plastic, clear  
 Sockelleuchte; Aluguss, schwarz / Kunststoff, klar  
 luminaire pour socle; fonte d'aluminium, noir / plastique, transparent

L 170, B 170, H 300, Base: Ø 170



E27



1x 60W



IP44



9 002759 930998

### 93408 ALORIA

floor light; cast aluminium, black / plastic, clear  
 Stehleuchte; Aluguss, schwarz / Kunststoff, klar  
 lampadaire; fonte d'aluminium, noir / plastique, transparent

L 170, B 170, H 940, Base: Ø 170



E27



1x 60W



IP44



9 002759 934088



**93095**

DESIGN  
HIGHLIGHT  
DETAIL

### 93095 ALORIA

wall light; cast aluminium, white / plastic, clear  
Wandleuchte; Aluguss, weiss / Kunststoff, klar  
Applique; fonte d'aluminium, blanc / plastique, transparent

L 170, H 225, A 190



E27



1x 60W



IP44



9 002759 930950



### 93403 ALORIA

wall light; cast aluminium, white / plastic, clear  
Wandleuchte; Aluguss, weiss / Kunststoff, klar  
Applique; fonte d'aluminium, blanc / plastique, transparent

L 180, H 200, A 120



E27



1x 60W



IP44



9 002759 934033





93403



**93456**



**93458**



110°, 7 m  
5 sec. - 5 min.

**SAFETY &  
COMFORT**



**93457**

### 93456 NAVEDO

wall light; cast aluminium, black, silver-patina / glass, clear  
Wandleuchte; Aluguss, schwarz, silber-patina / Glas, klar  
Applique; fonte d'aluminium, noir, argent patiné / verre, transparent

L 200, H 475, A 285



9 002759 934569



### 93457 NAVEDO

wall light; cast aluminium, black, silver-patina / glass, clear  
Wandleuchte; Aluguss, schwarz, silber-patina / Glas, klar  
Applique; fonte d'aluminium, noir, argent patiné / verre, transparent

L 200, H 475, A 285



9 002759 934576



### 93458 NAVEDO

wall light; cast aluminium, black, silver-patina / glass, clear  
Wandleuchte; Aluguss, schwarz, silber-patina / Glas, klar  
Applique; fonte d'aluminium, noir, argent patiné / verre, transparent

L 200, H 425, A 285



9 002759 934583







**93459**



**93462**



**93455**

**93459 NAVEDO**

wall light; cast aluminium, black, silver-patina / glass, clear  
Wandleuchte; Aluguss, schwarz, silber-patina / Glas, klar  
Applique; fonte d'aluminium, noir, argent patiné / verre, transparent

L 290, H 430, A 130

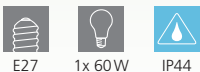

E27 1x 60W IP44



9 002759 934590



**93462 NAVEDO**

pedestal light; cast aluminium, black, silver-patina / glass, clear  
Sockelleuchte; Aluguss, schwarz, silber-patina / Glas, klar  
luminaire pour socle; fonte d'aluminium, noir, argent patiné / verre, transparent

H 470, Ø 230, Base: Ø 170



E27 1x 60W IP44



9 002759 934620



**93455 NAVEDO**

pendant light; cast aluminium, black, silver-patina / glass, clear  
Hängeleuchte; Aluguss, schwarz, silber-patina / Glas, klar  
luminaire en suspension; fonte d'aluminium, noir, argent patiné / verre, transparent

H 1045, Ø 230



E27 1x 60W IP44



9 002759 934552





93446



93447



110°, 7 m  
5 sec. - 5 min.

**SAFETY &  
COMFORT**



93448

### 93446 NAVEDO

wall light; cast aluminium, white / glass, clear  
Wandleuchte; Aluguss, weiss / Glas, klar  
Applique; fonte d'aluminium, blanc / verre, transparent

L 200, H 475, A 285



9 002759 934460



### 93448 NAVEDO

wall light; cast aluminium, white / glass, clear  
Wandleuchte; Aluguss, weiss / Glas, klar  
Applique; fonte d'aluminium, blanc / verre, transparent

L 290, H 430, A 130

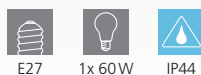

9 002759 934484



### 93447 NAVEDO

wall light; cast aluminium, white / glass, clear  
Wandleuchte; Aluguss, weiss / Glas, klar  
Applique; fonte d'aluminium, blanc / verre, transparent

L 200, H 425, A 285



9 002759 934477





93445

### 93445 NAVEDO

wall light; cast aluminium, white / glass, clear

Wandleuchte; Aluguss, weiss / Glas, klar

Applique; fonte d'aluminium, blanc / verre, transparent

L 200, H 475, A 285



E27



1x 60 W



IP44





93463



93452



93464

### 93463 NAVEDO

floor light; cast aluminium, black, silver-patina / glass, clear  
Stehleuchte; Aluguss, schwarz, silber-patina / Glas, klar  
lampadaire; fonte d'aluminium, noir, argent patiné / verre, transparent

H 1200, Ø 230, Base: Ø 170



E27 1x 60W IP44



9 002759 934637



### 93452 NAVEDO

floor light; cast aluminium, white / glass, clear  
Stehleuchte; Aluguss, weiss / Glas, klar  
lampadaire; fonte d'aluminium, blanc / verre, transparent

H 1200, Ø 230, Base: Ø 170

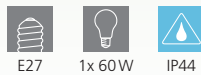

E27 1x 60W IP44



9 002759 934521



### 93464 NAVEDO

floor light; cast aluminium, black, silver-patina / glass, clear  
Stehleuchte; Aluguss, schwarz, silber-patina / Glas, klar  
lampadaire; fonte d'aluminium, noir, argent patiné / verre, transparent

H 2000, Ø 230, Base: Ø 245

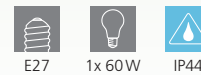

E27 1x 60W IP44



9 002759 934644





93465



93454



### 93465 NAVEDO

floor light; cast aluminium, black, silver-patina / glass, clear  
 Stehleuchte; Aluguss, schwarz, silber-patina / Glas, klar  
 lampadaire; fonte d'aluminium, noir, argent patiné / verre, transparent

H 2200, Ø 560, Base: Ø 230



E27



3x 60W



IP44

Ø 560



H 2200

Ø 230



9 002759 934651

### 93454 NAVEDO

floor light; cast aluminium, white / glass, clear  
 Stehleuchte; Aluguss, weiss / Glas, klar  
 lampadaire; fonte d'aluminium, blanc / verre, transparent

H 2200, Ø 560, Base: Ø 230



E27



3x 60W



IP44

Ø 560



H 2200

Ø 230



9 002759 934545





**22467**



DESIGN  
HIGHLIGHT  
DETAIL

#### 22467 LATERNA 4

wall light; cast aluminium, black / glass, clear  
Wandleuchte; Aluguss, schwarz / Glas, klar  
Applique; fonte d'aluminium, noir / verre, transparent

L 165, H 350, A 210



E27



1x 60W



IP44



9 002759 224677





22468



22469



120°, 8 m  
5 sec. - 9 min.

**SAFETY &  
COMFORT**



22471

#### 22468 LATERNA 4

wall light; cast aluminium, black / glass, clear  
Wandleuchte; Aluguss, schwarz / Glas, klar  
Applique; fonte d'aluminium, noir / verre, transparent

L 165, H 320, A 230



E27



1x 60 W



IP44



9 002759 224684



#### 22469 LATERNA 4

wall light; cast aluminium, black / glass, clear  
Wandleuchte; Aluguss, schwarz / Glas, klar  
Applique; fonte d'aluminium, noir / verre, transparent

L 165, H 360, A 215



E27



1x 60 W



IP44



9 002759 224691



#### 22471 LATERNA 4

pendant light; cast aluminium, black / glass, clear  
Hängeleuchte; Aluguss, schwarz / Glas, klar  
luminaire en suspension; fonte d'aluminium, noir / verre, transparent

H 900, Ø 205



E27



1x 60 W



IP44



9 002759 224714





**22463**



**22464**



120°, 8 m  
5 sec. - 9 min.

**SAFETY &  
COMFORT**

**22463 LATERNA 5**

wall light; cast aluminium, white / glass, clear  
Wandleuchte; Aluguss, weiss / Glas, klar  
Applique; fonte d'aluminium, blanc / verre, transparent

**22464 LATERNA 5**

wall light; cast aluminium, white / glass, clear  
Wandleuchte; Aluguss, weiss / Glas, klar  
Applique; fonte d'aluminium, blanc / verre, transparent

**22462 LATERNA 5**

wall light; cast aluminium, white / glass, clear  
Wandleuchte; Aluguss, weiss / Glas, klar  
Applique; fonte d'aluminium, blanc / verre, transparent

L 165, H 320, A 230



L 165, H 360, A 215

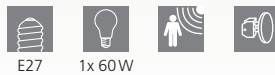

L 165, H 350, A 210

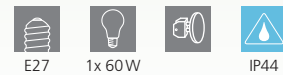





22462



22472



22144



22145

### 22472 LATERNA 4

pedestal light; cast aluminium, black / glass, clear  
Sockelleuchte; Aluguss, schwarz / Glas, klar  
luminaire pour socle; fonte d'aluminium, noir / verre, transparent

H 385, Ø 195, Base: Ø 170



### 22144 LATERNA 4

floor light; cast aluminium, black / glass, clear  
Stehleuchte; Aluguss, schwarz / Glas, klar  
lampadaire; fonte d'aluminium, noir / verre, transparent

H 1000, Ø 205, Base: Ø 170

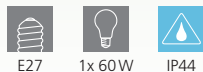

### 22145 LATERNA 4

floor light; cast aluminium, black / glass, clear  
Stehleuchte; Aluguss, schwarz / Glas, klar  
lampadaire; fonte d'aluminium, noir / verre, transparent

H 1920, Ø 550, Base: Ø 260

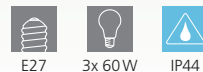



**22466**



**22995**



**22996**

### 22466 LATERNA 5

pedestal light; cast aluminium, white / glass, clear  
 Sockelleuchte; Aluguss, weiss / Glas, klar  
 luminaire pour socle; fonte d'aluminium, blanc / verre, transparent

H 385, Ø 195, Base: Ø 170

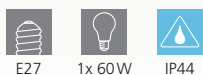

E27 1x 60W IP44



9 002759 224660

### 22995 LATERNA 5

floor light; cast aluminium, white / glass, clear  
 Stehleuchte; Aluguss, weiss / Glas, klar  
 lampadaire; fonte d'aluminium, blanc / verre, transparent

H 1030, Ø 195, Base: Ø 170

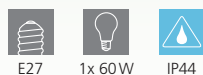

E27 1x 60W IP44



9 002759 229955

### 22996 LATERNA 5

floor light; cast aluminium, white / glass, clear  
 Stehleuchte; Aluguss, weiss / Glas, klar  
 lampadaire; fonte d'aluminium, blanc / verre, transparent

H 1920, Ø 535, Base: Ø 260

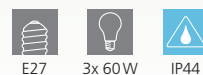

E27 3x 60W IP44



9 002759 229962

# SPOTS, RECESSED & ACCESSORIES

SPOTS, EINBAULEUCHTEN & ZUBEHÖR

SPOTS, LUMINAIRES ENCASTRÉS & ACCESSOIRES

## HIGHLIGHTS FOR OUTDOORS

Any outdoor area can be skilfully presented with spots, fitted lamps and the associated accessories. Stairwells, paths or the favourite spot in your garden will become a highlight this way.

## HIGHLIGHTS FÜR DRAUSSEN

Mit Spots, Einbauleuchten und den dazugehörigen Accessoires lässt sich jeder Außenbereich gekonnt in Szene setzen. Treppenaufgänge, Wege oder der Lieblingsplatz im Garten werden so zum Highlight.



## POINTS FORTS POUR L'EXTÉRIEUR

Des spots, les luminaires encastrables et les accessoires associés mettent en scène avec savoir tout espace extérieur. Les accès à des escaliers, les chemins ou bien votre emplacement préféré deviennent ainsi le centre des attentions.

# OVERVIEW

 PAGINO 172	 SPINETOLI 175	 NEMA 175	 NEMA 1 176	 FAEDO 4 176-177	 FAEDO 3 178-185	 DETECT ME 1 186,189	 DETECT ME 3 186,189
 DETECT ME 6 186,189	 DETECT ME 5 187	 LAMEDO 190	 RIGA 3 190	 TRONTO 191	 SALITTA 192	 ARACENA 193	 ZIMBA 194
 ZIMBA-LED 194	 MARGO 196	 LM_LED_E27 198	 PARK 4 200-201	 CONNECTOR BOX 201	 CUBA 202	 202	

 This product is available in different colors and shapes. / Dieser Artikel ist in unterschiedlichen Farben und Formen verfügbar.  
Cet article est disponible en différentes couleurs et formes.

98176

The spotlights of the luminaire are movable.  
The sensors of the luminaire can be swivelled 180 degrees horizontally and 135 degrees vertically. The sensor of the luminaire can be swivelled horizontally by 340 degrees.

Die Strahler der Leuchte sind beweglich.  
Die Sensoren der Leuchte sind um 180 Grad horizontal und 135 Grad vertikal schwenkbar.  
Der Sensor der Leuchte ist um 340 Grad horizontal schwenkbar.

Les spots du luminaire sont mobiles.  
Les capteurs du luminaire sont orientables de 180 degrés à l'horizontale et de 135 degrés à la verticale.  
et 135 degrés verticalement. Le capteur de la lampe est inclinable de 340 degrés à l'horizontale, peut être orienté.

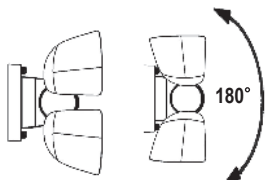
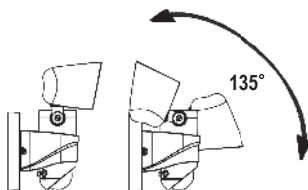
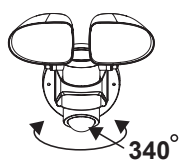

98176



150°, 12 m  
5 sec. - 3 min.

**SAFETY & COMFORT**



**98176 PAGINO**

wall light; plastic, black  
Wandleuchte; Kunststoff, schwarz  
Applique; plastique, noir

L 245, H 220, A 180



13W



1800lm



IP44



9 002759 981761



**98178 PAGINO**

wall light; plastic, black  
Wandleuchte; Kunststoff, schwarz  
Applique; plastique, noir

L 180, H 260, A 160



13W



2200lm



IP44



9 002759 981785





98178



150°, 12 m  
5 sec. - 3 min.

**SAFETY &  
COMFORT**



98184

LED

HIGH  
IP



98184

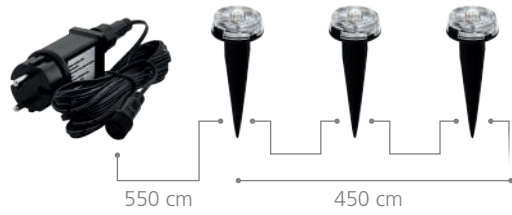

94111



94111

NEMA comes with 3 different coloured bulb shades.

NEMA wird mit 3 verschiedenenfarbigen Leuchtmittelabdeckungen ausgeliefert.

NEMA vient avec 3 couvercles d'ampoule en couleurs différentes.

- GL2642
- GL2643
- GL2641



### 98184 SPINETOLI

ground spike; plastic, transparent / plastic, transparent  
 Erdspieß; Kunststoff, transparent / Kunststoff, transparent  
 piquet de terre; plastique, transparent / plastique, transparent

L 10000, B 30, H 10, ET 500



9x 0,4W



243lm



IP65



9 002759 981846



L 10000

### 94111 NEMA

ground spike; stainless steel, stainless steel  
 Erdspieß; Edelstahl, edelstahl  
 piquet de terre; acier inoxydable, acier inoxydable

L 110, B 85, H 240, ET 165



GU10



1x 4,5W



1x 345lm



1500



IP54



9 002759 941116



L 110

H 240



93384



97471



93385



**93384 NEMA 1**

ground spike; plastic, black / plastic, transparent  
 Erdspieß; Kunststoff, schwarz / Kunststoff, transparent  
 piquet de terre; plastique, noir / plastique, transparent

**93385 NEMA 1**

ground spike; plastic, black / plastic, transparent  
 Erdspieß; Kunststoff, schwarz / Kunststoff, transparent  
 piquet de terre; plastique, noir / plastique, transparent

**97471 FAEDO 4**

ground spike; aluminium, black / glass, clear  
 Erdspieß; Alu, schwarz / Glas, klar  
 piquet de terre; aluminium, noir / verre, transparent

L 115, B 60, H 185

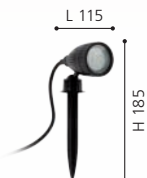

L 115, B 115, H 180



L 115, B 35, H 310

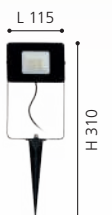



98185

LED

### 98185 FAEDO 4

flood light; aluminium, black / plastic, white  
 Strahler; Alu, schwarz / Kunststoff, weiss  
 projecteur; aluminium, noir / plastique, blanc

L 130, H 90, A 25



10W



900lm



1500



remote control



IP44



9 002759 981853



### 98185

This FAEDO 4 comes with included remote control.

Diese FAEDO 4 wird mit einer Fernbedienung ausgeliefert.

Ce FAEDO 4 est livré avec une télécommande.





97455



97456



97457



### 97455 FAEDO 3

wall light; aluminium, black / glass, clear  
Wandleuchte; Alu, schwarz / Glas, klar  
Applique; aluminium, noir / verre, transparent

L 110, H 80, A 30



### 97456 FAEDO 3

wall light; aluminium, black / glass, clear  
Wandleuchte; Alu, schwarz / Glas, klar  
Applique; aluminium, noir / verre, transparent

L 130, H 95, A 30



### 97457 FAEDO 3

wall light; aluminium, black / glass, clear  
Wandleuchte; Alu, schwarz / Glas, klar  
Applique; aluminium, noir / verre, transparent

L 175, H 135, A 30

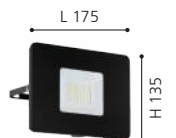
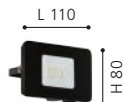



97458



900256



### 97458 FAEDO 3

wall light; aluminium, black / glass, clear  
 Wandleuchte; Alu, schwarz / Glas, klar  
 Applique; aluminium, noir / verre, transparent

L 205, H 145, A 30



### 900256 FAEDO 3

wall light; aluminium, black / glass, clear  
 Wandleuchte; Alu, schwarz / Glas, klar  
 Applique; aluminium, noir / verre, transparent

L 270, H 190, A 35





97459



120°, 12 m  
5 sec. - 60 min.

**SAFETY &  
COMFORT**



97461



120°, 12 m  
5 sec. - 5 min.

**SAFETY &  
COMFORT**



97462



120°, 12 m  
5 sec. - 60 min.

**SAFETY &  
COMFORT**

**97459 FAEDO 3**

wall light; aluminium, black / glass, clear  
Wandleuchte; Alu, schwarz / Glas, klar  
Applique; aluminium, noir / verre, transparent

**97461 FAEDO 3**

wall light; aluminium, black / glass, clear  
Wandleuchte; Alu, schwarz / Glas, klar  
Applique; aluminium, noir / verre, transparent

**97462 FAEDO 3**

wall light; aluminium, black / glass, clear  
Wandleuchte; Alu, schwarz / Glas, klar  
Applique; aluminium, noir / verre, transparent

L 110, H 135, A 50



10W 1000lm



IP44



9 002759 974596



L 130, H 140, A 50



21W 2300lm



IP44



9 002759 974619



L 175, H 190, A 50



31W 3400lm



IP44



9 002759 974626





900257

LED



120°, 1 m  
5 sec. - 10 min.

**SAFETY & COMFORT**



97463

LED



120°, 12 m  
5 sec. - 60 min.

**SAFETY & COMFORT**

### 900257 FAEDO 3

wall light; aluminium, black / glass, clear  
Wandleuchte; Alu, schwarz / Glas, klar  
Applique; aluminium, noir / verre, transparent

L 295, H 260, A 60

LED

102W

neutral  
WHITE

11100lm



IP44

L 295



9 008606 234554

### 97463 FAEDO 3

wall light; aluminium, black / glass, clear  
Wandleuchte; Alu, schwarz / Glas, klar  
Applique; aluminium, noir / verre, transparent

L 205, H 200, A 50

LED

53W

neutral  
WHITE

5800lm



IP44

L 205



9 002759 974633



33152



33153



33154



### 33152 FAEDO 3

wall light; aluminium, white / glass, clear  
Wandleuchte; Alu, weiss / Glas, klar  
Applique; aluminium, blanc / verre, transparent

### 33153 FAEDO 3

wall light; aluminium, white / glass, clear  
Wandleuchte; Alu, weiss / Glas, klar  
Applique; aluminium, blanc / verre, transparent

### 33154 FAEDO 3

wall light; aluminium, white / glass, clear  
Wandleuchte; Alu, weiss / Glas, klar  
Applique; aluminium, blanc / verre, transparent

L 110, H 80, A 30



L 130, H 95, A 30



L 175, B 40, H 135, A 80



9 002759 331528

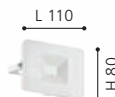

9 002759 331535

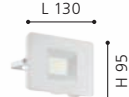

9 002759 331542

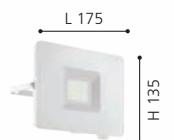





33155



### 33155 FAEDO 3

wall light; aluminium, white / glass, clear  
Wandleuchte; Alu, weiss / Glas, klar  
Applique; aluminium, blanc / verre, transparent

L 205, H 145, A 30

LED

53W

neutral  
WHITE

5800lm



IP65



9 002759 331559

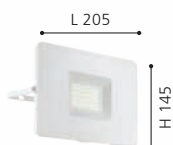



33156

LED



120°, 12 m  
5 sec. - 60 m

**SAFETY &  
COMFORT**



33157

LED



120°, 12 m  
5 sec. - 5 min.

**SAFETY &  
COMFORT**



33158

LED



120°, 12 m  
5 sec. - 60 min.

**SAFETY &  
COMFORT**

### 33156 FAEDO 3

wall light; aluminium, white / glass, clear  
Wandleuchte; Alu, weiss / Glas, klar  
Applique; aluminium, blanc / verre, transparent

L 110, H 135, A 50



10W 1000lm



IP44



9 002759 331566

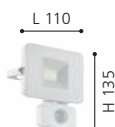

### 33157 FAEDO 3

wall light; aluminium, white / glass, clear  
Wandleuchte; Alu, weiss / Glas, klar  
Applique; aluminium, blanc / verre, transparent

L 130, H 140, A 50



21W 2300lm



IP44



9 002759 331573

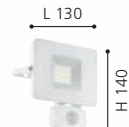

### 33158 FAEDO 3

wall light; aluminium, white / glass, clear  
Wandleuchte; Alu, weiss / Glas, klar  
Applique; aluminium, blanc / verre, transparent

L 175, H 190, A 50



31W 3400lm



IP44



9 002759 331580





33159



120°; 12 m  
5 sec. - 60 min.

**SAFETY &  
COMFORT**

### 33159 FAEDO 3

wall light; aluminium, white / glass, clear  
Wandleuchte; Alu, weiss / Glas, klar  
Applique; aluminium, blanc / verre, transparent

L 205, H 200, A 50

LED

53W

neutral  
WHITE

5800lm



IP44



9 002759 331597

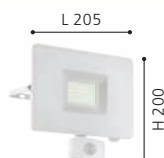



96454



180°, 12 m  
10 sec. - 15 min.

**SAFETY &  
COMFORT**



97465



160°, 12 m  
10 sec. - 15 min.

**SAFETY &  
COMFORT**



97422



360°, 12 m  
10 sec. - 15 min.

**SAFETY &  
COMFORT**

### 96454 DETECT ME 1

motion detector; plastic, black  
Bewegungsmelder; Kunststoff, schwarz  
détecteur de mouvement; plastique, noir

L 55, H 70, A 80



IP44

### 97465 DETECT ME 3

motion detector; plastic, black  
Bewegungsmelder; Kunststoff, schwarz  
détecteur de mouvement; plastique, noir

L 100, H 100, A 55



IP44

### 97422 DETECT ME 6

motion detector; plastic, black / plastic, white  
Bewegungsmelder; Kunststoff, schwarz / Kunststoff, weiss  
détecteur de mouvement; plastique, noir / plastique, blanc

Ø 90, A 55



IP44



9 002759 964542



9 002759 974657

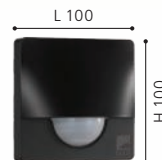

9 002759 974220

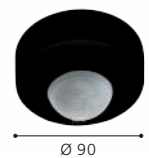



**97419**

Automatic illumination. This photo-electric lighting controller is used for controlling lighting systems for building fronts. It automatically switches light 'ON' at dusk automatically 'OFF' again at dawn. Of course, the light-level threshold at which the sensor responds and turns the light 'ON' is defined by no other than you yourself.

Automatische Beleuchtung. Der Day & Night Sensor dient zur Steuerung von Beleuchtungsanlagen an Hausfronten und schaltet bei Dämmerung automatisch das Licht AN und am Morgen automatisch wieder AUS. Die Dämmerungsschwelle, bei der der Sensor reagiert und die Beleuchtung schaltet, definieren Sie natürlich selbst.

Un éclairage automatique. Un éclairage automatique. L'interrupteur crépusculaire pour la commande des installations d'éclairage pour les façades de maison.

Il allume automatiquement la lumière au crépuscule et l'éteint automatiquement à l'aube. C'est naturellement à vous de définir le seuil de luminosité auquel doit réagir le détecteur et allumer la lumière.



**97419**



**SAFETY & COMFORT**

## 97419 DETECT ME 5

Sensor; plastic, black  
 Sensor; Kunststoff, schwarz  
 Sensor; plastique, noir

L 65, H 95, A 35



IP44

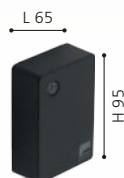



96452



180°, 12 m  
10 sec. - 15 min.

**SAFETY &  
COMFORT**



97464



160°, 12 m  
10 sec. - 15 min.

**SAFETY &  
COMFORT**



DETECT ME 1

DETECT ME 3

DETECT ME 6



MOUNT ON  
CEILING



MOUNT  
ON WALL

		•
•	•	

Accessories incl. / Zubehör inkl. / Accessoires inclus



10 sec. - 15 min.	10 sec. - 15 min.	10 sec. - 15 min.
12 m	12 m	12 m
180°,	160°,	360°,
+/- 40° horizontal +/- 45° vertical		
3 - 2000 lx	3 - 2000 lx	3 - 2000 lx
max. 800 W incandescent max. 400 W fluorescent/LED	max. 1200 W incandescent max. 300 W fluorescent/LED	max. 1200 W incandescent max. 300 W fluorescent/LED

Ideal mounting height / Ideale Montagehöhe / Hauteur de montage ideale: ~ 2m



97421



360°, 12 m  
10 sec. - 15 min.

**SAFETY &  
COMFORT**

### 96452 DETECT ME 1

motion detector; plastic, white  
Bewegungsmelder; Kunststoff, weiss  
détecteur de mouvement; plastique, blanc

L 55, H 70, A 80



IP44



### 97464 DETECT ME 3

motion detector; plastic, white  
Bewegungsmelder; Kunststoff, weiss  
détecteur de mouvement; plastique, blanc

L 100, H 100, A 55



IP44

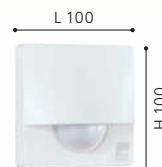

### 97421 DETECT ME 6

motion detector; plastic, white / plastic, white  
Bewegungsmelder; Kunststoff, weiss / Kunststoff, weiss  
détecteur de mouvement; plastique, blanc / plastique, blanc

Ø 90, A 55



IP44





93481



93482



86189



### 93481 LAMEDO

ground recessed light; stainless steel, stainless steel / satin glass, white

Bodeneinbauleuchte; Edelstahl, edelstahl / Glas satiniert, weiss  
luminaire encastrable au; acier inoxydable, acier inoxydable / verre satiné, blanc

L 100, B 100, ET 65



1x 2,5W 230lm



IP65/67



9 002759 934811

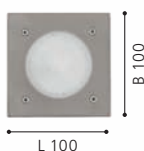

L 100

### 93482 LAMEDO

ground recessed light; stainless steel, stainless steel / satin glass, white

Bodeneinbauleuchte; Edelstahl, edelstahl / Glas satiniert, weiss  
luminaire encastrable au; acier inoxydable, acier inoxydable / verre satiné, blanc

Ø 100, ET 65



1x 2,5W 230lm



IP65/67



9 002759 934828



Ø 100

### 86189 RIGA 3

ground recessed light; stainless steel, stainless steel / plastic, white

Bodeneinbauleuchte; Edelstahl, edelstahl / Kunststoff, weiss  
luminaire encastrable au; acier inoxydable, acier inoxydable / plastique, blanc

H 285, Ø 170



E27 1x 16W IP67



9 002759 861896



Ø 170



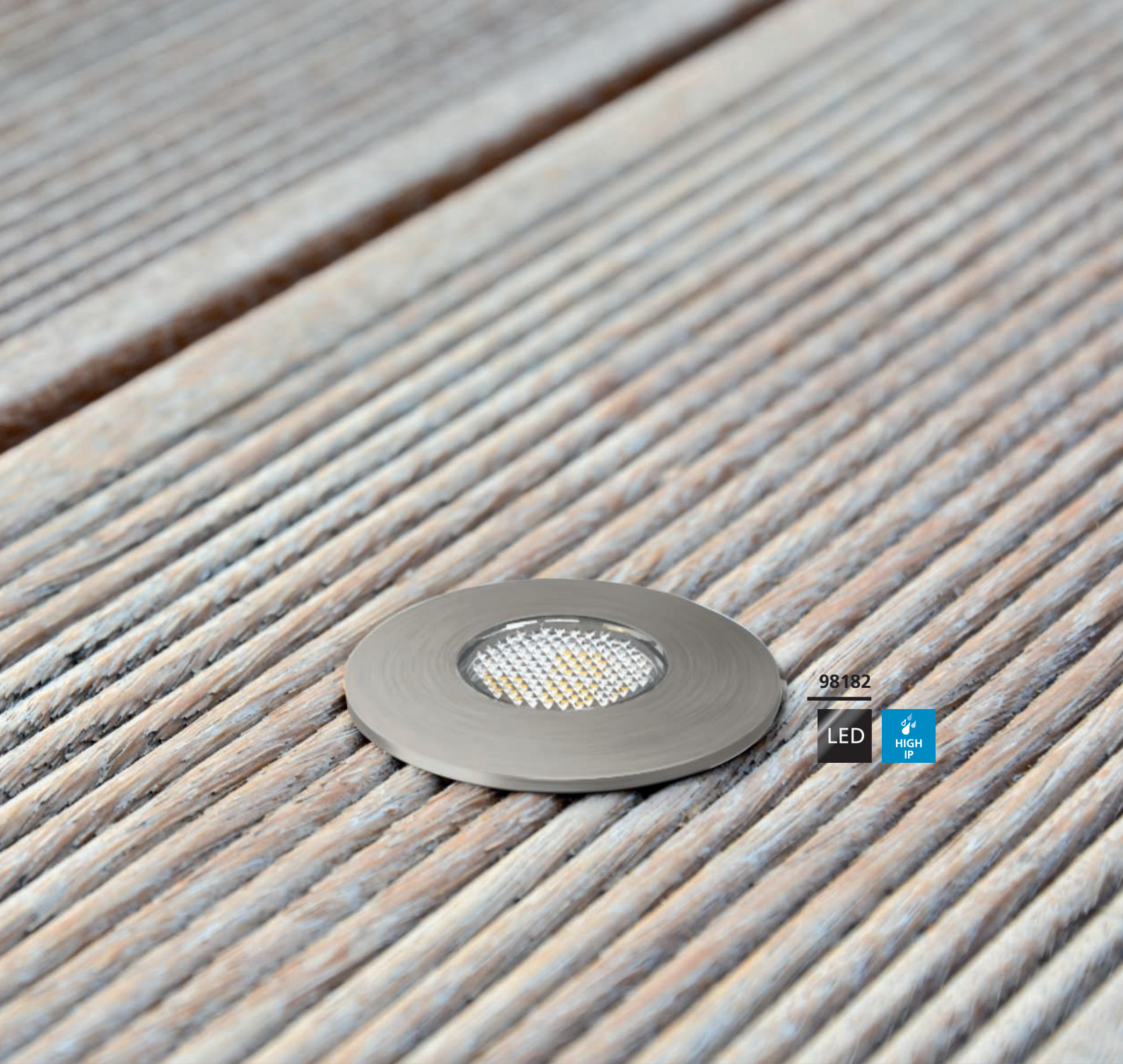

98182



### 98182 TRONTO

ground recessed light; stainless steel, plastic, stainless steel,  
black / plastic, transparent

Bodeneinbauleuchte; Edelstahl, Kunststoff, edelstahl, schwarz /  
Kunststoff, transparent

luminaire encastrable au; acier inoxydable, plastique, acier  
inoxydable, noir / plastique, transparent

H 2, Ø 45, ET 70



1W



50lm



Ø35



IP65/67



9 002759 981822



Ø 45



900263



900264



### 900263 SALITTA

recessed light; aluminium, steel, black / plastic, white  
 Einbauleuchte; Alu, Stahl, schwarz / Kunststoff, weiss  
 luminaire encastrable; aluminium, acier, noir / plastique, blanc

L 400, B 75, H 55, ET 52



### 900264 SALITTA

recessed light; aluminium, steel, black / plastic, white  
 Einbauleuchte; Alu, Stahl, schwarz / Kunststoff, weiss  
 luminaire encastrable; aluminium, acier, noir / plastique, blanc

L 600, B 75, H 55, ET 52





99574

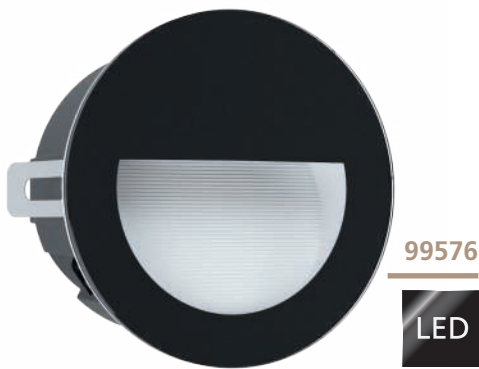

99576



99577



### 99574 ARACENA

recessed light; aluminium, plastic, white, black / glass, black  
 Einbauleuchte; Alu, Kunststoff, weiss, schwarz / Glas, schwarz  
 luminaire encastrable; aluminium, plastique, blanc, noir / verre, noir

L 140, B 140, H 5, ET 95



133x130



9 002759 995744

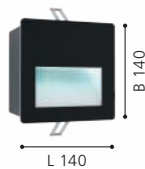

### 99576 ARACENA

recessed light; aluminium, plastic, white, black / glass, black  
 Einbauleuchte; Alu, Kunststoff, weiss, schwarz / Glas, schwarz  
 luminaire encastrable; aluminium, plastique, blanc, noir / verre, noir

H 5, Ø 125, ET 95



Ø 117



9 002759 995768



### 99577 ARACENA

recessed light; aluminium, plastic, white, black / glass, white  
 Einbauleuchte; Alu, Kunststoff, weiss, schwarz / Glas, weiss  
 luminaire encastrable; aluminium, plastique, blanc, noir / verre, blanc

H 5, Ø 125, ET 95



Ø 117



9 002759 995775





88575



95233



### 88575 ZIMBA

recessed light; cast aluminium, silver / satin glass, white  
 Einbauleuchte; Aluguss, silber / Glas satiniert, weiss  
 luminaire encastrable; fonte d'aluminium, argent / verre satiné, blanc

L 227, B 127, H 13, ET 75

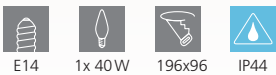

E14 1x 40W 196x96 IP44



9 002759 885755



L 227

### 95233 ZIMBA-LED

recessed light; cast aluminium, silver  
 Einbauleuchte; Aluguss, silber  
 luminaire encastrable; fonte d'aluminium, argent

H 5, Ø 125, ET 95



LED 2,5W neutral WHITE 300lm Ø117



IP65



9 002759 952334



Ø 125

### 95235 ZIMBA-LED

recessed light; cast aluminium, silver  
 Einbauleuchte; Aluguss, silber  
 luminaire encastrable; fonte d'aluminium, argent

L 140, B 140, H 5, ET 95



LED 3,7W neutral WHITE 500lm 133x130



IP65



9 002759 952358

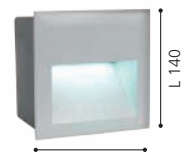

B 140

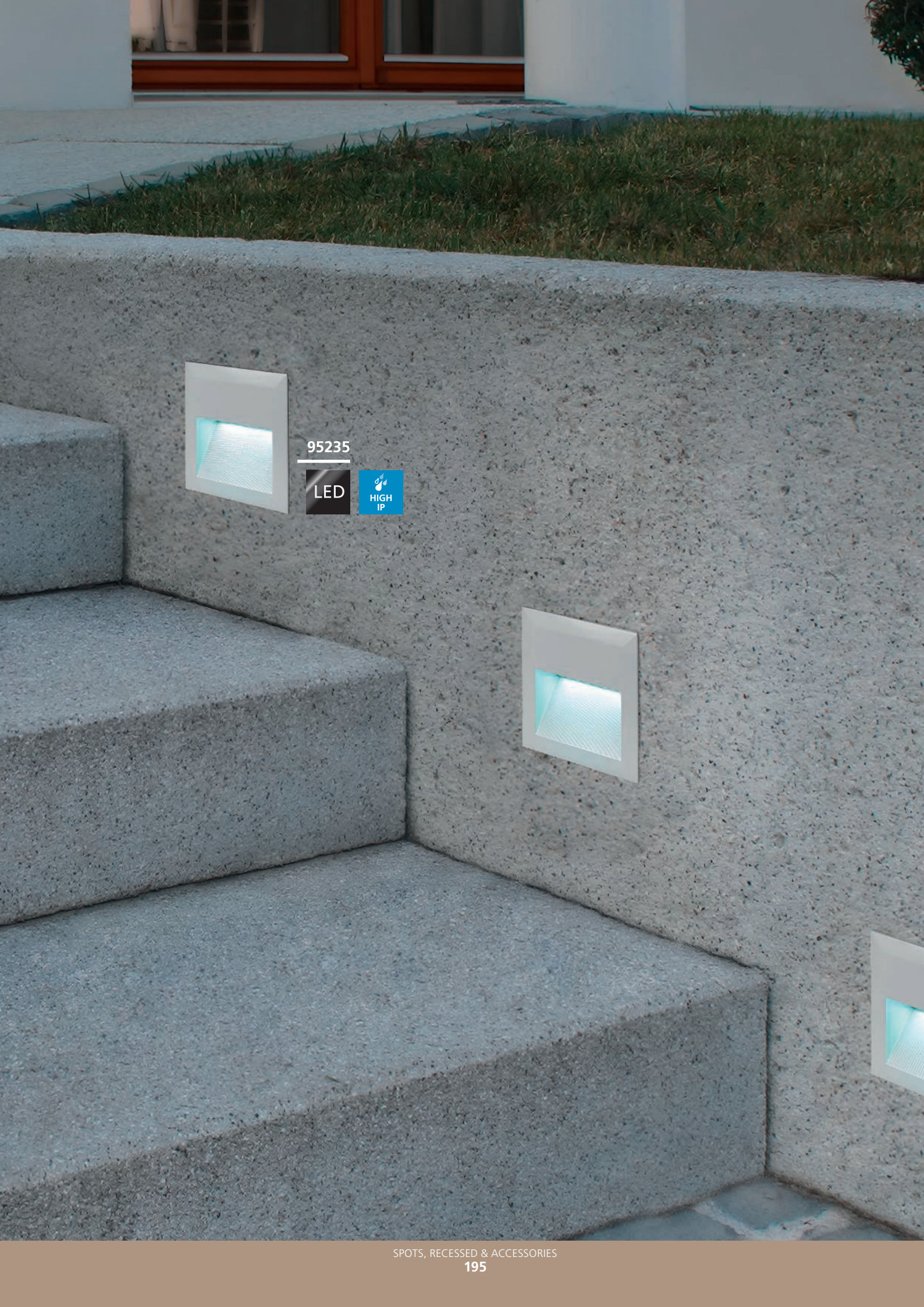

95235

LED

HIGH  
IP





94093



### 94093 MARGO

recessed light; cast aluminium, white / satin glass, white  
 Einbauleuchte; Aluguss, weiss / Glas satiniert, weiss  
 luminaire encastrable; fonte d'aluminium, blanc / verre satiné, blanc

H 10, Ø 84, ET 125



GU10



1x 4,5W



1x  
345lm



Ø 78



IP65/20



9 002759 940935



Ø 84

### 94092 MARGO

recessed light; cast aluminium, stainless steel / satin glass, white  
 Einbauleuchte; Aluguss, edelstahl / Glas satiniert, weiss  
 luminaire encastrable; fonte d'aluminium, acier inoxydable / verre satiné, blanc

H 10, Ø 84, ET 125



GU10



1x 4,5W



1x  
345lm



Ø 78



IP65/20



9 002759 940928



Ø 84



94092

LED

HIGH  
IP



SAFETY &  
COMFORT



DAY & NIGHT  
SENSOR  
INTEGRATED

### 110187 E27-LED-A60

<b>806 lm</b>	<b>warm WHITE</b>	<b>3000 K</b>	
---------------	-------------------	---------------	--

L 106, Ø 60	not dimmable	80 CRI
7.3 W	25000 h	Day/night-Sensor
220-240V,50/60Hz	8	
E27	7.3 W ~ 60 W	



SAFETY &  
COMFORT



DAY & NIGHT  
SENSOR  
INTEGRATED

### 110189 E27-LED-A60

<b>470 lm</b>	<b>warm WHITE</b>	<b>3000 K</b>	
---------------	-------------------	---------------	--

L 106, Ø 60	not dimmable	80 CRI
4.5 W	25000 h	Day/night-Sensor
220-240V,50/60Hz	8	
E27	4.5 W ~ 40 W	



SAFETY &  
COMFORT



SENSOR  
DAY & NIGHT  
SENSOR  
INTEGRATED

### 110186 E27-LED-A60

<b>830 lm</b>	<b>warm WHITE</b>	<b>2700 K</b>	
---------------	-------------------	---------------	--

L 116, Ø 60	not dimmable	80 CRI
9 W	25000 h	Motion Sensor & day/night-Sensor
220-240V,50/60Hz	8	
E27	9 W ~ 60 W	







DAY & NIGHT  
SENSOR  
INTEGRATED

110187, 110189

#### Security and Comfort for little money

This bulb has a Day & Night sensor and switches on automatically at dusk or off at dawn. Thanks to the E27 socket the bulb can easily be exchanged for existing luminaires. With an average electricity price of € 0,16/KWh and an average lighting time of 8 hours/day, the costs amount to approx. € 5,00 per year.

#### Sicherheit und Komfort für wenig Geld

Dieses Leuchtmittel verfügt über einen Day & Night-Sensor und schaltet sich selbstständig bei Dunkelheit ein bzw. bei Helligkeit aus. Dank der E27-Fassung kann das Leuchtmittel einfach in bestehende Leuchten getauscht werden. Bei einem durchschnittlichen Strompreis von € 0,16/KWh und einer durchschnittlichen Leuchtdauer von 8 Stunden/Tag belaufen sich die Kosten auf ca. € 5,00 pro Jahr.

#### Sécurité et confort pour peu d'argent

Cette ampoule possède un capteur Day & Night et s'allume automatiquement au crépuscule ou à l'aube. Grâce à la prise E27, l'ampoule peut être facilement échangée. Avec un prix moyen de l'électricité de € 0,16 / KWh et un temps d'éclairage moyen de 8 heures / jour, les coûts s'élèvent à env. € 5,00 par an.



110186



#### MICROWAVE MOTION SENSOR

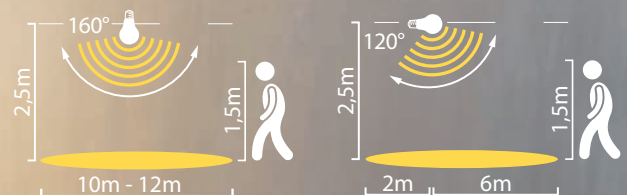



90748



93426

#### 90748 PARK 4

accessory; stainless steel, stainless steel / plastic, green  
Zubehör; Edelstahl, edelstahl / Kunststoff, grün  
Accessoires; acier inoxydable, acier inoxydable / plastique, marron granit

L 110, B 110, H 400, Base: B 155, T 155



IP44



9 002759 907488





91206



### CONNECTOR BOX

No more annoying cables in your garden: bury them simply and safely with the CONNECTOR BOX.

- 91206: 1 supply line and 2 distribution lines
- 91207: 1 supply line and 5 distribution lines

Mit der CONNECTOR BOX können Sie störende Kabel einfach und sicher unter der Erde verschwinden lassen.

- 91206: 1 Zuleitung und 2 Verteilungsleitungen
- 91207: 1 Zuleitung und 5 Verteilungsleitungen

Tous les câbles incommodants disparaissent simplement et sûrement dans votre jardin avec CONNECTOR BOX.

- 91206: 1 alimentation et 2 lignes de distribution
- 91207: 1 alimentation et 5 lignes de distribution



91207



### 93426 PARK 4

accessory; steel, plastic, black  
Zubehör; Stahl, Kunststoff, schwarz  
Accessoires; acier, plastique, noir

L 110, B 110, H 400, Base: B 155, T 155



IP44

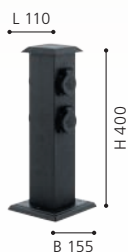

9 002759 934262

### 91206 CONNECTOR BOX

accessory; plastic, black  
Zubehör; Kunststoff, schwarz  
Accessoires; plastique, noir

H 50, Ø 155



IP68



9 002759 912062



### 91207 CONNECTOR BOX

accessory; plastic, black  
Zubehör; Kunststoff, schwarz  
Accessoires; plastique, noir

H 50, Ø 155



IP68



9 002759 912079





**88744**



**88153**

**88744**

With the CUBA ground spike you can stick your floor luminaire in the ground or set it in concrete.

Mit dem CUBA Erdspeer können Sie Ihre Stehleuchte in den Boden stecken oder einbetonieren.

Avec le piquet de terre CUBA vous pouvez fixer votre lampadaire en sol ou au béton.

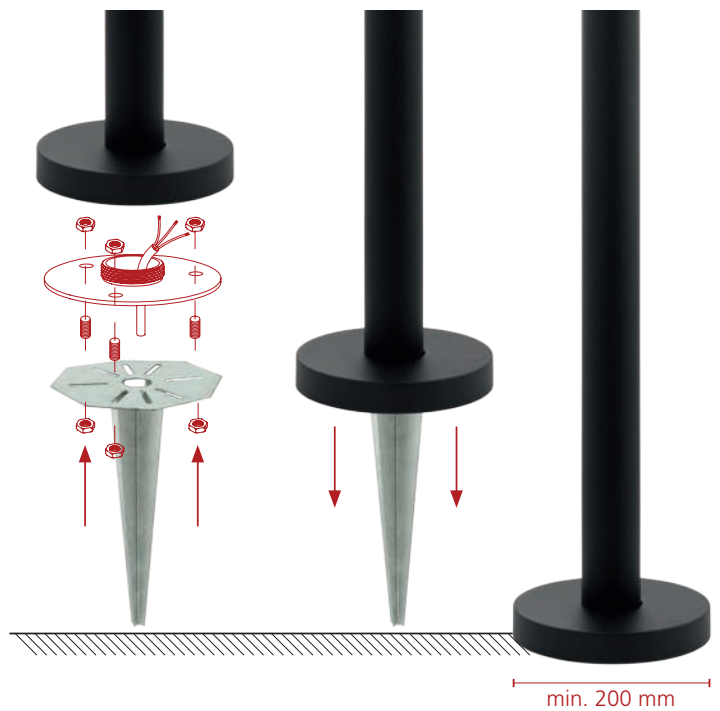

**88744 CUBA**

ground spike; steel, zinc-plated  
Erdspeer; Stahl, feuerverzinkt  
piquet de terre; acier, galvanisé à chaud

H 300, Ø 185



9 002759 887445



**88153**

accessory; steel, black  
Zubehör; Stahl, schwarz  
Accessoires; acier, noir

H 50, Ø 112



9 002759 881535

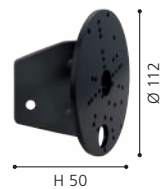

**88152**

accessory; steel, white  
Zubehör; Stahl, weiss  
Accessoires; acier, blanc

H 50, Ø 112



9 002759 881528

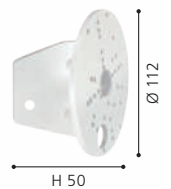



**88152**



**88152, 88153**

The above mentioned pictogram indicates suitable luminaires which can be easily mounted on corners with this accessories.

Das oben gezeigte Piktogramm markiert passende Leuchten, welche mit dem Zubehör einfach an Ecken montiert werden können.

Le pictogramme ci-dessus marque les luminaires correspondant, qui peut être monté avec les accessoires simples dans les coins.

# GARDEN LIVING

## OUTDOOR ATMOSPHERE

If the outdoor living room is to become an oasis of well-being, the right lighting must not be missing. The products from the Garden Living range create the right atmosphere. Cosy table and floor lamps, decorative pendant lights and light chains as well as colourful light bands transform every garden into a unique eye-catcher that invites you to linger and relax in the open air on warm summer evenings.

## ATMOSPHÄRE IM FREIEN

Wenn das Outdoor-Wohnzimmer zur Wohlfühloase werden soll, darf die richtige Beleuchtung nicht fehlen. Die Produkte aus dem Garden Living Sortiment schaffen dafür die richtige Atmosphäre. Wohnliche Tisch- und Stehleuchten, dekorative Hängeleuchten und Lichterketten sowie farbenfrohe Leuchtbänder verwandeln jeden Garten in einen einzigartigen Blickfang, der zum Verweilen und Relaxen an warmen Sommerabenden unter freiem Himmel einlädt.

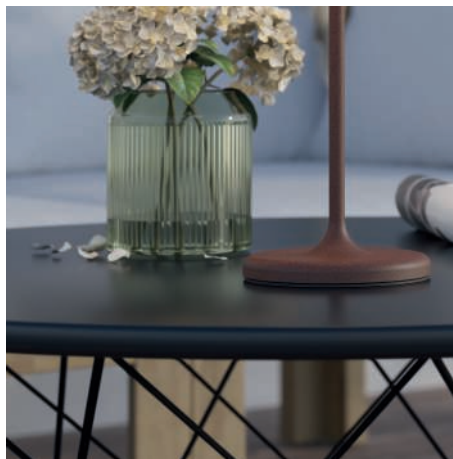

## AMBIANCE EXTÉRIEURE

Pour que le salon extérieur devienne une oasis de bien-être, le bon éclairage ne doit pas manquer. Les produits de la gamme Garden Living créent l'atmosphère adéquate. Des lampes de table et des lampadaires confortables, des suspensions et des chaînes lumineuses décoratives, ainsi que des bandes lumineuses colorées transforment chaque jardin en une attraction unique qui vous invite à vous attarder et à vous détendre en plein air lors des chaudes soirées d'été.

# OVERVIEW

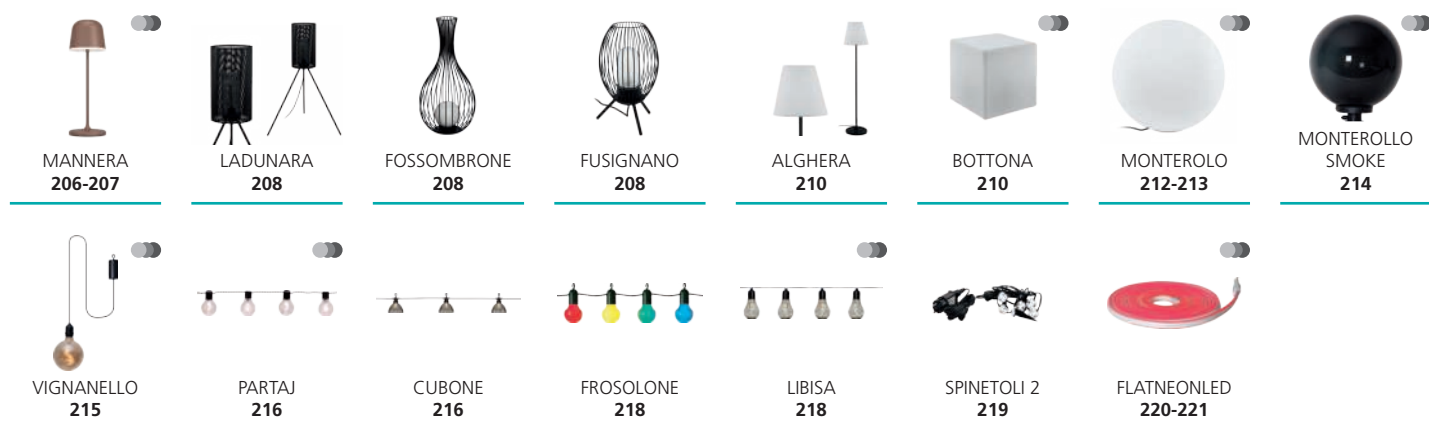

This product is available in different colors and shapes. / Dieser Artikel ist in unterschiedlichen Farben und Formen verfügbar.  
Cet article est disponible en différentes couleurs et formes.





TOUCH  
ME



900457

LED

HIGH  
IP

### 900457 MANNERA

table light; aluminium, steel, black / plastic, white  
Tischleuchte; Alu, Stahl, schwarz / Kunststoff, weiss  
luminaire de table; aluminium, acier, noir / plastique, blanc

H 340, Ø 110, Base: Ø 110

LED

2,2W

warm  
WHITE

200lm



ACCU

Li-ion

1800mAh



IP54



9 008606 243990

Ø 110



H 340

Ø 110



## MANNERA

These luminaires can be switched on and off by touching the specially designed "Touch Me" part of the fixture.

Diese Leuchten können ein- und ausgeschaltet werden, indem man sie an den dafür vorgesehenen "Touch Me" Bereichen berührt.

Ces luminaires peuvent être éteints et allumés simplement en touchant la partie spécialement conçue pour "Touch Me" du luminaire.



### 900459 MANNERA

table light; aluminium, steel, auburn / plastic, white  
Tischleuchte; Alu, Stahl, rostbraun / Kunststoff, weiss  
luminaire de table; aluminium, acier, brun rouille / plastique, blanc

H 340, Ø 110, Base: Ø 110



### 900461 MANNERA

table light; aluminium, steel, sandy / plastic, white  
Tischleuchte; Alu, Stahl, sandfarben / Kunststoff, weiss  
luminaire de table; aluminium, acier, couleur sable / plastique, blanc

H 340, Ø 110, Base: Ø 110



### 900458 MANNERA

table light; aluminium, steel, grey / plastic, white  
Tischleuchte; Alu, Stahl, grau / Kunststoff, weiss  
luminaire de table; aluminium, acier, gris / plastique, blanc

H 340, Ø 110, Base: Ø 110





900259

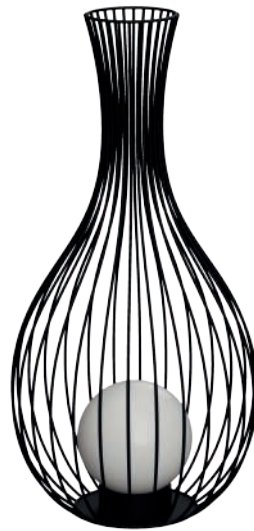

900122



### 900259 LADUNARA

floor light; steel, black  
Stehleuchte; Stahl, schwarz  
lampadaire; acier, noir

### 900122 FOSSOMBRONE

floor light; zinc-plated steel, black / plastic, white  
Stehleuchte; Stahl verzinkt, schwarz / Kunststoff, weiss  
lampadaire; acier galvanisé, noir / plastique, blanc

### 900123 FUSIGNANO

table light; zinc-plated steel, black / glass etched, white  
Tischleuchte; Stahl verzinkt, schwarz / Glas geätzt, weiss  
luminaire de table; acier galvanisé, noir / verre gravé, blanc

H 1170, Ø 250, Base: Ø 660



H 685, Ø 320, Base: Ø 230

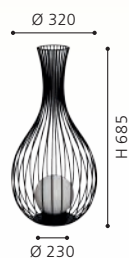
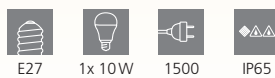

H 410, Ø 265

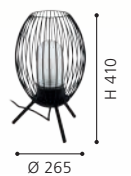
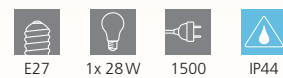



900123



### 900296

On/off switch on the lampshade.  
 Ein/Aus-Schalter am Lampenschirm.  
 Interrupteur marche/arrêt sur l'abat-jour.

900296



### BOTTONA

Bulb not included!  
 Leuchtmittel sind nicht inkludiert!  
 L'ampoule sont non inclus !



### 900296 ALGHERA

floor light; plastic, black / plastic, white  
 Stehleuchte; Kunststoff, schwarz / Kunststoff, weiss  
 lampadaire; plastique, noir / plastique, blanc

H 1485, Ø 390



E27 1x 15W 2000 IP44



9 008606 232598

### 900294 BOTTONA

floor light; plastic, white  
 Stehleuchte; Kunststoff, weiss  
 lampadaire; plastique, blanc

L 300, B 300, H 300



E27 1x 15W 2000 IP65

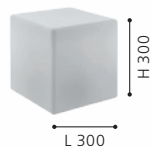

9 008606 232574

### 900295 BOTTONA

floor light; plastic, white  
 Stehleuchte; Kunststoff, weiss  
 lampadaire; plastique, blanc

L 400, B 400, H 400



E27 1x 15W 2000 IP65

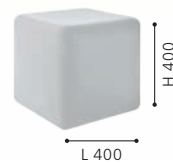

9 008606 232581



900295



900294





98101



98103



### 98101 MONTEROLO

floor light; plastic, white / plastic, white  
 Stehleuchte; Kunststoff, weiss / Kunststoff, weiss  
 lampadaire; plastique, blanc / plastique, blanc

### 98103 MONTEROLO

floor light; plastic, white / plastic, white  
 Stehleuchte; Kunststoff, weiss / Kunststoff, weiss  
 lampadaire; plastique, blanc / plastique, blanc

### 98102 MONTEROLO

floor light; plastic, white / plastic, white  
 Stehleuchte; Kunststoff, weiss / Kunststoff, weiss  
 lampadaire; plastique, blanc / plastique, blanc

H 300, Ø 300, Base: Ø 120



H 500, Ø 500, Base: Ø 195



H 390, Ø 390, Base: Ø 195



9 002759 981013



9 002759 981037



9 002759 981020

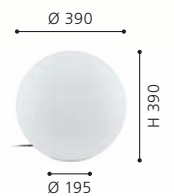



98104



98102



### 98104 MONTEROLO

floor light; plastic, white / plastic, white  
Stehleuchte; Kunststoff, weiss / Kunststoff, weiss  
lampadaire; plastique, blanc / plastique, blanc

H 600, Ø 600, Base: Ø 195



E27



1x 40 W



2000



IP65



9 002759 981044

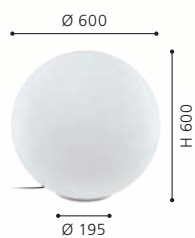



900203

900202

900201

### 900201 MONTEROLLO SMOKE

ground spike; plastic, black / plastic, black-transparent  
 Erdspieß; Kunststoff, schwarz / Kunststoff, schwarz-transparent  
 piquet de terre; plastique, noir / plastique, noir transparent

### 900202 MONTEROLLO SMOKE

ground spike; plastic, black / plastic, black-transparent  
 Erdspieß; Kunststoff, schwarz / Kunststoff, schwarz-transparent  
 piquet de terre; plastique, noir / plastique, noir transparent

### 900203 MONTEROLLO SMOKE

ground spike; plastic, black / plastic, black-transparent  
 Erdspieß; Kunststoff, schwarz / Kunststoff, schwarz-transparent  
 piquet de terre; plastique, noir / plastique, noir transparent

H 240, Ø 200



H 340, Ø 300



H 440, Ø 400



9 008606 229895



9 008606 229901



9 008606 229918







900209



900211



900208



### VIGNANELLO

4x AA batteries needed. Batteries not included!

4x AA Batterien erforderlich. Batterien sind nicht inkludiert!

4x AA batteries nécessaires. Les piles sont non inclus !

### 900209 VIGNANELLO

decoration for hanging; plastic, black / plastic, black-transparent  
 Dekoration zum Aufhängen; Kunststoff, schwarz / Kunststoff, schwarz-transparent

Décoration de Noël à susp; plastique, noir / plastique, noir transparent

H 195, Ø 125



1x 0,06W



9 008606 229932



### 900211 VIGNANELLO

decoration for hanging; plastic, black / plastic, amber  
 Dekoration zum Aufhängen; Kunststoff, schwarz / Kunststoff, amber

Décoration de Noël à susp; plastique, noir / plastique, ambre

H 195, Ø 125



1x 0,06W



9 008606 229949



### 900208 VIGNANELLO

decoration for hanging; plastic, black / plastic, transparent  
 Dekoration zum Aufhängen; Kunststoff, schwarz / Kunststoff, transparent

Décoration de Noël à susp; plastique, noir / plastique, transparent

H 195, Ø 125



1x 0,06W



9 008606 229925





900238

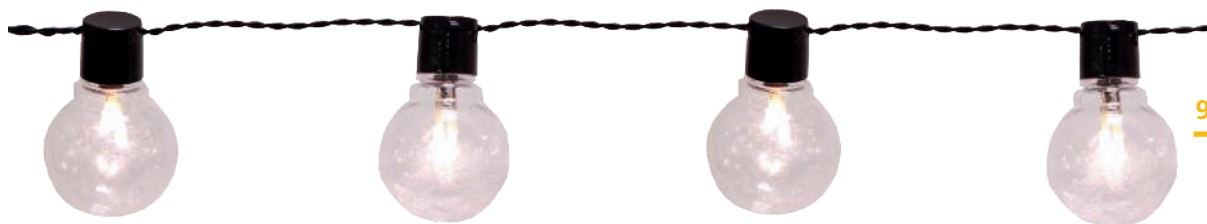

900213



### 900238 PARTAJ

fairy lights; plastic, white / plastic, transparent  
 Lichterkette; Kunststoff, weiss / Kunststoff, transparent  
 Guirlande lumineuse; plastique, blanc / plastique, transparent

### 900213 PARTAJ

fairy lights; plastic, black / plastic, transparent  
 Lichterkette; Kunststoff, schwarz / Kunststoff, transparent  
 Guirlande lumineuse; plastique, noir / plastique, transparent

### 900215 CUBONE

fairy lights; plastic, grey, black / plastic, transparent  
 Lichterkette; Kunststoff, grau, schwarz / Kunststoff, transparent  
 Guirlande lumineuse; plastique, gris, noir / plastique, transparent

L 4500, B 60, H 95

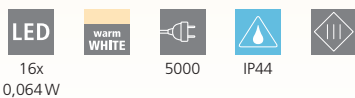

L 4500, B 60, H 95

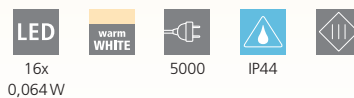

L 4950, B 90, H 105

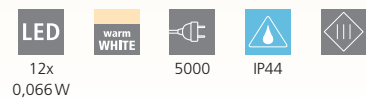

9 008606 229970



9 008606 229758

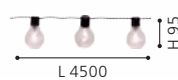

9 008606 229765





900215

LED



900212

LED



900239

LED



900299

LED

### 900117, 900299

Timer function: 8h on and 16h off when timer is activated.

Timerfunktion: 8h an und 16h aus bei Timer Aktivierung.

Fonction minuterie : 8h de marche et 16h d'arrêt lorsque la minuterie est activée.

### 900299

2x AA batteries needed. Batteries not included!

2x AA Batterien erforderlich. Batterien sind nicht inkludiert!

2x AA batteries nécessaires. Les piles sont non inclus !

### 900212 FROSLONE

fairy lights; plastic, green / plastic, coloured  
Lichterkette; Kunststoff, grün / Kunststoff, bunt  
Guirlande lumineuse; plastique, vert / plastique, coloré

L 5700, B 50, H 110



20x  
0,064W



5000



IP44



### 900239 LIBISA

fairy lights; plastic, white  
Lichterkette; Kunststoff, weiss  
Guirlande lumineuse; plastique, blanc

L 7350, B 25, H 35



50x  
0,066W



3000



IP44



### 900299 LIBISA

fairy lights; plastic, black-transparent  
Lichterkette; Kunststoff, schwarz-transparent  
Guirlande lumineuse; plastique, noir transparent

L 4050, B 57, H 110



10x  
0,06W



3000



IP44



9 008606 229741



L 5700



9 008606 229987



L 7350



9 008606 230068



L 4050

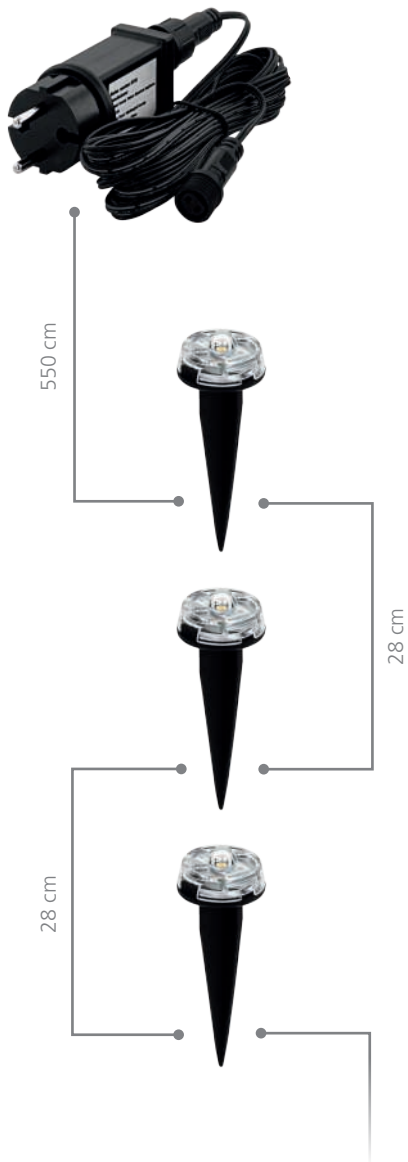

900117

LED



**900117 SPINETOLI 2**

ground spike; plastic, transparent / plastic, transparent  
 Erdspieß; Kunststoff, transparent / Kunststoff, transparent  
 piquet de terre; plastique, transparent / plastique, transparent

L 6900, B 30, H 10, ET 500



6x 0,4W



162lm



5500



IP65



9 008606 231621



L 6900

H 10



900219

LED



900221

LED



900224

LED



900223

LED

### 900219 FLATNEONLED

bar / strip light; plastic, pink  
Leuchtband/-stab; Kunststoff, pink  
bande lumineuse / bâton l; plastique, rose

### 900221 FLATNEONLED

bar / strip light; plastic, blue  
Leuchtband/-stab; Kunststoff, blau  
bande lumineuse / bâton l; plastique, bleu

### 900223 FLATNEONLED

bar / strip light; plastic, red  
Leuchtband/-stab; Kunststoff, rot  
bande lumineuse / bâton l; plastique, rouge

L 5000, B 15, H 6

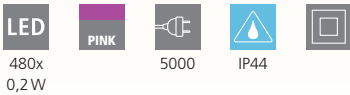

L 5000, B 15, H 6

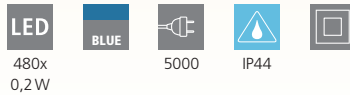

L 5000, B 15, H 6

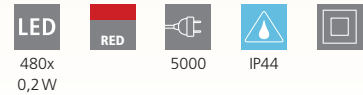

9 008606 229802



L 5000



9 008606 229819



L 5000



9 008606 229833



L 5000

DESIGN  
HIGHLIGHT  
DETAIL



900222

LED

### 900224 FLATNEONLED

bar / strip light; plastic, coloured  
Leuchtband/-stab; Kunststoff, bunt  
bande lumineuse / bâton l; plastique, coloré

L 3000, B 15, H 16



288x  
0,2W



5000



IP44



### 900222 FLATNEONLED

bar / strip light; plastic, green  
Leuchtband/-stab; Kunststoff, grün  
bande lumineuse / bâton l; plastique, marron granit

L 5000, B 15, H 6



480x  
0,2W



5000



IP44



9 008606 229864

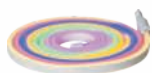

L 3000



9 008606 229826



L 5000

# SOLAR

SOLAR  
SOLAIRE

## THE GREEN ALTERNATIVE

These exterior lights all feature modern solar technology and high-quality batteries. With zero electricity costs, they make the perfect statement for anyone who values sustainability.

Since they don't need cables or a power connection, these lights can be placed anywhere where there is enough sunlight.

## DIE GRÜNE ALTERNATIVE

Diese Außenleuchten verfügen alle über moderne Solartechnologie und hochwertige Akkus. Sie sind das perfekte Statement für alle jene, denen Nachhaltigkeit wichtig ist und verursachen keine Stromkosten. Unabhängig von Kabel- und Stromanschluss sind diese Leuchten überall platzierbar wo genügend Sonne scheint.



## LA SOLUTION ÉCOLOGIQUE

Ces luminaires extérieurs sont tous équipés d'une technologie solaire moderne et de batteries performantes.

Ils représentent le choix idéal pour tous ceux qui accordent une grande importance à la protection de l'environnement. Par ailleurs, ils n'engendrent pas de frais énergétiques. Ces luminaires n'ont pas besoin d'être raccordés à l'alimentation et peuvent donc être placés partout où ils peuvent être exposés au soleil.



# OVERVIEW



 This product is available in different colors and shapes. / Dieser Artikel ist in unterschiedlichen Farben und Formen verfügbar.  
Cet article est disponible en différentes couleurs et formes.

**900243, 900244, 900245, 900246,  
900804, 900805**

The luminaires 900245 & 900246 have 300 lm for 25 seconds when the sensor is activated and then 30 lm constantly. The luminaires 900243 & 900244 have 400 lumens for 30 seconds when the sensor is activated and then 15 lumens constantly. The luminaires 900804 & 900805 have 340 lm for 45 seconds when the sensor is activated and then 15 lm constantly.

Die Leuchten **900245 & 900246** haben bei der Aktivierung des Sensors **300 Lumen für 25 Sekunden** und dann **konstant 30 Lumen**. Die Leuchten **900243 & 900244** haben bei der Aktivierung des Sensors **400 Lumen für 30 Sekunden** und dann **konstant 15 Lumen**. Die Leuchten **900804 & 900805** haben bei der Aktivierung des Sensors **340 Lumen für 45 Sekunden** und dann **konstant 15 Lumen**.

Les lumières 900245 et 900246 ont 300 lumens pendant 25 secondes lorsque le capteur est activé, puis 30 lumens en permanence. Les lumières 900243 et 900244 ont 400 lumens pendant 30 secondes lorsque le capteur est activé, puis 15 lumens en permanence. Les lumières 900804 et 900805 ont 340 lumens pendant 45 secondes lorsque le capteur est activé, puis 15 lumens en permanence.



**900245 BARACCONI**

wall light; aluminium, plastic, black / plastic, transparent  
Wandleuchte; Alu, Kunststoff, schwarz / Kunststoff, transparent  
Applique; aluminium, plastique, noir / plastique, transparent

L 90, H 200, A 200

- LED 18x 0,2W
- warm WHITE 300lm
- Li-ion ACCU 2200 mAh



**900246 BARACCONI**

floor light; aluminium, plastic, black / plastic, satiné  
Stehleuchte; Alu, Kunststoff, schwarz / Kunststoff, satiniert  
lampadaire; aluminium, plastique, noir / plastique, satiné

L 90, B 200, H 800

- LED 18x 0,2W
- warm WHITE 300lm
- Li-ion ACCU 2200 mAh



**900243 CORBEZZOLA**

wall light; plastic, graphite / plastic, white  
Wandleuchte; Kunststoff, graphit / Kunststoff, weiss  
Applique; plastique, noir graphite / plastique, blanc

L 160, H 160, A 200

- LED 6x 0,03 W
- warm WHITE 400lm
- Li-ion ACCU 1500 mAh





900244



SAFETY & COMFORT



900804



110°, 8 m  
45 sec. - 45 sec.

SAFETY & COMFORT



900805



90°, 8 m  
45 sec. - 45 sec.

SAFETY & COMFORT

### 900244 CORBEZZOLA

floor light; plastic, graphite / plastic, white  
Stehleuchte; Kunststoff, graphit / Kunststoff, weiss  
lampadaire; plastique, noir graphite / plastique, blanc

H 900, Ø 160

LED 6x 0,03W 400lm  
warm WHITE  
Li-ion 1500mAh



IP44



9 008606 230037



### 900804 MARTANO

wall light; aluminium, black / plastic, white  
Wandleuchte; Alu, schwarz / Kunststoff, weiss  
Applique; aluminium, noir / plastique, blanc

L 180, B 150, H 270

LED 3,7W 340lm  
neutral WHITE  
Li-ion 2000mAh



IP44



9 008606 261871



L 180

### 900805 MARTANO

pedestal light; aluminium, black / plastic, white  
Sockelleuchte; Alu, schwarz / Kunststoff, weiss  
luminaire pour socle; aluminium, noir / plastique, blanc

L 150, B 150, H 800

LED 3,7W 340lm  
neutral WHITE  
Li-ion 2000mAh



IP44



9 008606 261888



L 150



98757



120°, 6 m  
18 sec. - 25 sec.

SAFETY & COMFORT



98758



120°, 6 m  
5 sec. - 15 sec.

SAFETY & COMFORT



900255



120°, 6 m  
18 sec. - 25 sec.

SAFETY & COMFORT

### 98757, 900255

**Mode A:** Automatically turns on at the dusk (< 30 lux) and remains 20% bright, up to 5 hours after which it turns off.

**Mode B:** Automatically turns on to full brightness (400 lm) when motion is detected in the range < 6 m and then turns to 3% brightness in 20 seconds of no motion.

**Mode C:** Automatically turns on to full brightness (400 lm) when motion is detected in the range < 6 m and then turns off in 30 seconds of no motion.

**Mode A:** Schaltet sich automatisch in den Dämmermodus (< 30 Lux) und bleibt bis zu 5 Stunden bei 20% der Helligkeit, bevor sie automatisch ausschaltet.

**Mode B:** Schaltet sich automatisch auf volle Helligkeit (400 lm), wenn eine Bewegung im Umkreis von 6 Metern erkannt wird, um nach 20 Sekunden ohne Bewegung auf 3% Helligkeit abzumindern.

**Mode C:** Schaltet sich automatisch auf volle Helligkeit (400 lm), wenn eine Bewegung im Umkreis von 6 Metern erkannt wird, um nach 30 Sekunden ohne Bewegung abzuschalten.

**Mode A:** Allume automatiquement le crépuscule (< 30 lux) et conserve 20% de luminosité, jusqu'à 5 heures, après lesquelles il s'éteint.

**Mode B:** Allume automatiquement en pleine luminosité (400 lm) lorsqu'un mouvement est détecté au sein d'une portée de 6 mètres, puis passe à 3% de luminosité, lors d'une absence de mouvement pendant 20 secondes.

**Mode C:** Allume automatiquement en pleine luminosité (400 lm) lorsqu'un mouvement est détecté au sein d'une portée de 6 mètres, puis s'éteint, lors d'une absence de mouvement pendant 30 secondes.

### 98757 LAMOZZO

wall light; plastic, white / plastic, transparent  
Wandleuchte; Kunststoff, weiss / Kunststoff, transparent  
Applique; plastique, blanc / plastique, transparent

L 140, H 210, A 110



3,2W 440lm Li-ion



2000mAh 6h IP54



9 002759 987572



### 900255 LAMOZZO

wall light; plastic, black / plastic, transparent  
Wandleuchte; Kunststoff, schwarz / Kunststoff, transparent  
Applique; plastique, noir / plastique, transparent

L 140, H 210, A 110



3,2W 440lm Li-ion



2000mAh 6h IP54



9 008606 231287



### 98758 LAMOZZO 1

wall light; plastic, black / plastic, transparent  
Wandleuchte; Kunststoff, schwarz / Kunststoff, transparent  
Applique; plastique, noir / plastique, transparent

L 105, H 200, A 90



2W 264lm Li-ion



1200mAh 6h IP44



9 002759 987589



## 98758

	Battery above 30%		Battery below 30%	
	Front light*	Back light*	Front light	Back light
Motion detected	100 %	100 %	100 %	100 %
Motion out of range	weak	weak	off	weak

Automatically turns on to full brightness (400lm) when motion is detected in the range <6m and then turns to 3% brightness in 10 seconds if no motion is detected.

	Batterie über 30 %		Batterie unter 30 %	
	vorne	hinten	vorne	hinten
Bewegung erkannt	100 %	100 %	100 %	100 %
außerhalb Bereich	schwach	schwach	aus	schwach

Schaltet sich automatisch auf volle Helligkeit (400 lm), wenn eine Bewegung im Umkreis von 6 Metern erkannt wird, um nach 10 Sekunden ohne Bewegung auf 3% Helligkeit abzdimmten.

	Batterie de plus de 30 %		Batterie moins de 30 %	
	de face	retour	de face	retour
Mouvement détecté	100 %	100 %	100 %	100 %
hors de portée	faible	faible	éteint	faible

Allume automatiquement en pleine luminosité (400 lm) lorsqu'un mouvement est détecté au sein d'une portée de 6 mètres, puis passe à 3 % de luminosité, lors d'une absence de mouvement pendant 10 secondes.



48944



120°, 5 m

**SAFETY & COMFORT**

## 48968

**3 OPERATING MODES - Mode A** is 200 lumen constant light. **Mode B** is 800 lumen for 20 seconds when Sensor is activated then dimming to 200 lumen for 20 seconds and then off. **Mode C** is 800 lumen for 20 seconds when Sensor is activated the off.

**3 BETRIEBSMODI - Modus A** ist 200 Lumen konstantes Licht. **Modus B** ist 800 Lumen für 20 Sekunden, wenn der Sensor aktiviert wird, dann wird er für 20 Sekunden auf 200 Lumen gedimmt und dann ausgeschaltet. **Modus C** ist 800 Lumen für 20 Sekunden, wenn der Sensor ausgeschaltet ist.

**3 MODES DE FONCTIONNEMENT - Le mode A** est une lumière constante de 200 lumens. **Le mode B** est de 800 lumens pendant 20 secondes lorsque le capteur est activé, puis diminue à 200 lumens pendant 20 secondes, puis s'éteint. **Le mode C** est de 800 lumens pendant 20 secondes lorsque le capteur est activé.



48968



120°, 5 m

**SAFETY & COMFORT**

### 48944 PORRASSA

solar light; plastic, black / plastic, white  
Solarleuchte; Kunststoff, schwarz / Kunststoff, weiss  
luminaire solaire; plastique, noir / plastique, blanc

L 155, H 75, A 100

LED  
40x 0,5W  
cold WHITE  
800lm

Li-ion  
2000mAh



6 - 8h



9 002759 489441



### 48968 UTRERA

solar light; plastic, black / plastic, white  
Solarleuchte; Kunststoff, schwarz / Kunststoff, weiss  
luminaire solaire; plastique, noir / plastique, blanc

L 200, B 90, H 120

LED  
32x  
0,12W  
neutral WHITE  
800lm

Li-ion  
2000mAh



20h



9 002759 489687

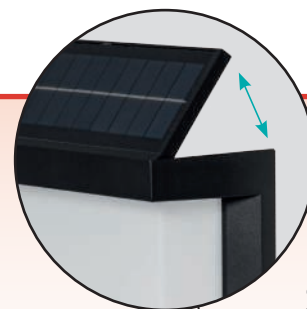

### 48968

The solar panel on the item is foldable.

Das Solarpanel am Artikel ist klappbar.

Le panneau solaire sur l'article est pliable.





900247



120°, 8 m

**SAFETY & COMFORT**



98195



140°, 9 m  
3 sec. - 7 min.

**SAFETY & COMFORT**



98196



140°, 9 m  
3 sec. - 7 min.

**SAFETY & COMFORT**

### 900247 VILLAGRAPPA

ground spike; steel, plastic, black  
Erdspieß; Stahl, Kunststoff, schwarz  
piquet de terre; acier, plastique, noir

### 98195 CASABAS

wall light; plastic, black / plastic, white  
Wandleuchte; Kunststoff, schwarz / Kunststoff, weiss  
Applique; plastique, noir / plastique, blanc

### 98196 CASABAS

wall light; plastic, white / plastic, white  
Wandleuchte; Kunststoff, weiss / Kunststoff, weiss  
Applique; plastique, blanc / plastique, blanc

L 150, B 80, H 160



15x  
0,03W



warm  
WHITE  
800lm



Li-ion



2600mAh



IP44

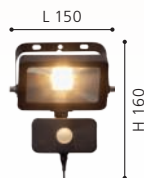

L 150

H 160



9 008606 230044

L 115, H 155, A 130



5W



cold  
WHITE  
470lm



Li-ion



1800mAh



IP44



L 115

H 155

A 130



9 002759 981952

L 115, H 155, A 130



5W



cold  
WHITE  
470lm



Li-ion



1800mAh



IP44



L 115

H 155

A 130



9 002759 981969



98187



90°, 8 m  
30 sec. -

**SAFETY &  
COMFORT**



98191



90°, 8 m  
40 sec. - 7 min.

**SAFETY &  
COMFORT**

**98187 PALIZZI**

wall light; plastic, black / plastic, transparent  
Wandleuchte; Kunststoff, schwarz / Kunststoff, transparent  
Applique; plastique, noir / plastique, transparent

L 155, H 145, A 110



2W



150lm



AA,  
Ni-Mh



600mAh



IP44



L 155



A 110



9 002759 981877

**98191 PASTION**

wall light; plastic, black  
Wandleuchte; Kunststoff, schwarz  
Applique; plastique, noir

L 180, H 120, A 130



4,5W



200lm



Li-ion



2200mAh



6h



L 180



A 130



9 002759 981914

# HOW TO READ

## ERKLÄRUNG

## COMMENT LIRE

SENSOR INCLUDED  
SENSOR INKLUDIERT  
SENSOR INCLUS

This symbol indicates luminaires with a sensor. In addition the Detection angle, Reach, Time setting (min./max.) and Response brightness (lx) is indicated.

Ist die Leuchte mit einem Sensor ausgestattet, wird dies durch ein Sensorsymbol gekennzeichnet. Zusätzlich werden Erfassungswinkel, Reichweite, Zeiteinstellung (max./min.) und die Ansprechhelligkeit (lx) angegeben.

Un produit avec cette symbole ont une détecteur de mouvement. Aussi le angle de détection, la minuterie et Luminosité de déclenchement (lx) sont indiqués.

**900137**  
90°, 6 m  
10 sec - 12 min  
SAFETY & COMFORT

**900138**

**900139**

**900137 ALAMONTE 3**  
wall light; aluminium, steel, black  
Wandleuchte; Alu, Stahl, schwarz  
applique; aluminium, acier, noir

**900138 ALAMONTE 3**  
pedestal light; aluminium, steel, black  
Sockelleuchte; Alu, Stahl, schwarz  
luminaire pour socle; aluminium, acier, noir

**900139 ALAMONTE 3**  
floor light; aluminium, steel, black  
Stehleuchte; Alu, Stahl, schwarz  
lampadaire; aluminium, acier, noir

L 170, H 295, A 100  
E27 1x 60W IP44

L 150, B 150, H 450  
E27 1x 60W IP44

L 150, B 150, H 1000  
E27 1x 60W IP44

9 008606 230112

9 008606 230129

9 008606 230136

CLASSIC  
122

SERIES NAME  
SERIENNAME  
NOM DE LA SÉRIE

ARTICLE NUMBER  
ARTIKELNUMMER  
NUMÉRO D'ARTICLE

DESCRIPTION  
BESCHREIBUNG  
DESCRIPTION

The product description is composed as follows:  
luminaire type; enclosure material, enclosure colour / glass or shade material, glass or shade colour

Die Produktbeschreibung setzt sich wie folgt zusammen:  
Leuchtenart; Gehäusematerial, Gehäusefarbe / Schirm- bzw. Glasmaterial, Schirm- bzw. Glasfarbe

La description du produit est composée comme suit:  
type de luminaire; matériel de boîtier, couleur de boîtier / matériel de verre ou abat-jour, couleur de verre ou abat-jour

DIMENSIONS  
DIMENSIONEN  
DIMENSIONS

all dimensions in mm | alle Größen in mm | toutes dimensions en mm

L = length | Länge | longueur

B = width | Breite | largeur

H = height | Höhe | hauteur

∅ = diameter | Durchmesser | diamètre

A = projection length | Ausladung | amplitude

ET = installation depth | Einbautiefe | profondeur utile

Base = base dimensions | Sockelmaße | dimensions de base

Attention! The dimensions relate solely to the sizes of the luminaire.  
Any air spaces that would be relevant for a safe operating of the lamp were not considered.

Achtung! Die Größen beziehen sich nur auf die Abmessungen der Leuchte. Etwaige Lufträume, die für einen sicheren Betrieb der Leuchte notwendig sind, werden nicht berücksichtigt.

Attention! Les dimensions se réfèrent à la taille de la lampe seulement. Espacements éventuels, que seraient importants pour une opération de la lampe sans danger, n'ont pas été considérés.

SKETCHES  
SKIZZEN  
CROQUIS

The sketches state the most meaningful dimensions. If a product is adjustable by will, a turquoise arrow marks this function and only the maximum dimensions are indicated.

Die Bemaßung der Skizzen umfasst jeweils die aussagekräftigsten Größen. Bei verstellbaren Produkten kennzeichnet ein türkiser Pfeil diese Funktion und nur die maximalen Größen werden angegeben.

Les dimensions des croquis comprennent les plus représentatives. Si un produit est réglable au choix, une flèche turquoise affiche cette fonction et rien que les dimensions maximales sont indiquées.



PRODUCT IN THE AMBIANCE  
PRODUKTE IM AMBIENTE  
PRODUITS DANS L'AMBIENCE

You can find the article number next to each product in the ambiance pictures.  
Sie finden die Artikelnummer neben jeder Abbildung des Produktes auf unseren Ambientebildern.  
Vous pouvez trouver le numéro d'article à côté de chaque produit dans les images de l'ambiance.



900136

900136 ALAMONTE 3

wall light; aluminium, steel, black  
Wandleuchte; Alu, Stahl, schwarz  
applique; aluminium, acier, noir

L 170, H 260, A 100



9 408406 230105

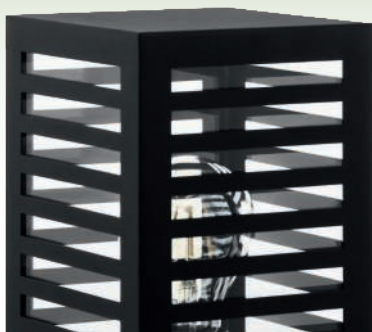

CLASSIC  
123

PICTOGRAMMES  
PIKTOGRAMME  
PICTOGRAMMES

Technical details are represented as pictograms. An overview over all pictograms can be found on the next pages.

Technische Details werden als Piktogramme dargestellt. Eine Übersicht über alle Piktogramme finden Sie auf den nächsten Seiten.

Les détails techniques sont représentés sous forme de pictogrammes. Vous trouverez un aperçu de tous les pictogrammes dans les pages suivantes.

ENERGY EFFICIENCY LABELS  
ENERGIEEFFIZIENZ-LABEL  
LABEL DE L'EFFICACITÉ ÉNERGÉTIQUE

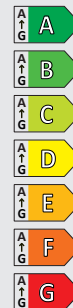
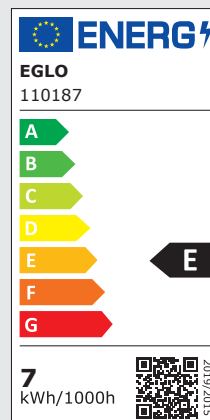

The new energy label must be indicated on all light sources with a luminous flux between 60 and 82,000 lumens and OLED. This applies to lamps, LED modules and luminaires where the light source cannot be removed without destroying it.

Das neue Energielabel muss auf allen Lichtquellen mit einem Lichtstrom zwischen 60 und 82.000 Lumen und OLED angegeben werden. Dies gilt für Lampen, LED-Module und Leuchten, bei denen die Lichtquelle nicht zerstörungsfrei entnommen werden kann.

Le nouveau label énergétique doit être indiqué sur toutes les sources lumineuses dont le flux lumineux est compris entre 60 et 82 000 lumens et sur les OLED. Cela s'applique aux lampes, aux modules LED et aux luminaires dont la source lumineuse ne peut être retirée sans être détruite.

The information on the label includes: / Die Angaben auf dem Etikett beinhalten: / Les informations figurant sur l'étiquette sont les suivantes :

- > Name/Trademark  
Name/Warenzeichen  
Nom/marque de commerce
- > Model / Modell / Modèle
- > Energy label scale A-G / Energielabel-Skala A-G / Échelle d'étiquetage énergétique A-G
- > Energy consumption for 1,000 hours of use/  
Energieverbrauch bei 1.000 Stunden Nutzung/  
Consommation d'énergie pour 1 000 heures d'utilisation
- > Energy efficiency class of the product/  
Energieeffizienzklasse des Produkts/  
Classe d'efficacité énergétique du produit
- > QR Code to EPREL (Product Database of the European Product Registry for Energylabelling)/  
QR Code zur EPREL (Produktdatenbank der European Product Registry for Energylabelling)/  
Code QR pour EPREL (base de données des produits du registre européen des produits pour l'étiquetage énergétique)

The energy spectrum ranges from G to A.  
Das Energiespektrum reicht von G bis A.  
Le spectre énergétique va de G à A.

# EGLO WORLDWIDE

EGLO WELTWEIT / EGLO DANS LE MONDE



 **AUSTRIA**  
EGLO LEUCHTEN GMBH  
Heiligkreuz 22  
6136 Pill  
T: +43 5242 6996 0 | F: +43 5242 6996 972  
info-austria@eglo.com

 **AUSTRALIA**  
EGLO LIGHTING AUSTRALIA  
5/339 Archerfield Road  
4077 Richlands | Queensland  
T: +61 7 3375 1413 | F: +61 7 3375 1412  
info@eglolighting.com.au

 **BELGIUM**  
EGLO BELGIUM BV  
Antwerpsesteenweg 247  
2950 Kapellen  
T: +32 3 250 60 80 | F: +32 3 219 80 67  
info-belgium@eglo.com

 **BOSNIA AND HERZEGOVINA**  
EGLO RASVJETA BH D.O.O.  
Ormanica bb  
76250 Gradacac  
T: +387 35 86 85 00 | F: +387 35 82 44 41  
info-Bosnia-Herzegovina@eglo.com

 **BULGARIA**  
EGLO BULGARIA EOOD  
Main Road Burgas-Sofia | 5th kilometer | Building EGLO  
8000 Burgas  
T: +359 56 960 403 | F: +359 56 53 05 95  
info-bulgaria@eglo.com

 **CANADA**  
EGLO CANADA INC.  
20700 Route Transcanadienne  
H9X 4B7 Baie D'Ufré, Quebec  
T: +1 514 457 5483 | F: +1 514 457 5487  
info-canada@eglo.com

 **CHILE**  
EGLO CHILE ILUMINACIÓN LTDA.  
Av. Américo Vespucio Norte 1930  
Conchalí - Santiago de Chile  
T: +562 2 595 2222  
info-chile@eglo.com

 **CHINA**  
DONGGUAN EGLO LIGHTING COMMERCIAL  
CO LTD  
No.1 | Shangqiao Industrial Rd Shangqiao, Dongcheng  
Dongguancity, Guanzhouprovince  
T: +86 769 2203 3866 | F: +86 769 2203 6866  
info-china@eglo.com

 **COLOMBIA**  
EGLO COLOMBIA ILUMINACIÓN SAS  
Autopista Norte 800 Mts adelante del Peaje de los Andes  
Costado Oriental Km 19 Lote 30  
Bogotá - Chia  
T: +57 (1) 744 2339  
info-global@eglo.com

 **COSTA RICA**  
EGLO COSTA RICA  
Centro Comercial Calle Real local #8  
Guachipilín de Escazú de la sucursal del BAC  
San Jose 800 metros al norte | San Jose  
T: +506-2289-4690 | F: +506-2100-6384  
info-costarica@eglo.com

 **CROATIA**  
EGLO RASVJETA D.O.O.  
Jadranska avenija 9a  
10000 Zagreb  
T: +385 1 379 40 62 | F: +385 1 379 41 04  
info-croatia@eglo.com

 **CZECH REPUBLIC**  
EGLO CZ+SK s.r.o.  
Náchodská 2479/63  
193 00 Praha 9 Horní Pocernice  
T: +420 281 924 163 | F: +420 281 925 205  
info-czechrepublic@eglo.com

 **DENMARK**  
EGLO DANMARK A/S  
Agerbakken 20  
8362 Hørning  
T: +45 70 22 55 11 | F: +45 70 22 55 221  
info-denmark@eglo.com

 **ESTONIA**  
MOODNE VALGUSTUS AS  
Rävalapst. 7  
10143 Tallinn  
T: +372 667 6670 | F: +372 631 3195  
info-global@eglo.com

 **FINLAND**  
EGLO FINLAND OY  
Malmiraitti 17A  
700 Helsinki  
T: +358 20 7649 820 | F: +358 20 7649 821  
info-finland@eglo.com

 **FRANCE**  
EGLO FRANCE LUMINAIRE SARL  
Z.A. Jeune Bois | 2 Rue de la Martinique  
68274 Wittenheim  
T: +33 3 89 62 50 45 | F: +33 389 6250 49  
info-france@eglo.com

 **GERMANY**  
EGLO LEUCHTEN HANDELS GMBH  
Kleinbahnstr. 35  
59759 Arnsberg  
T: +49 2932 6269 0 | F: +49 2932 6269 39  
info-germany@eglo.com

 **GREAT BRITAIN AND IRELAND**  
EGLO UK LTD.  
Unit 12 Cirrus Park, Lower Farm Road, Moulton Park  
Industrial Estate, Northampton NN3 6UR  
T: +44 1604 790 986 | F: +44 1604 670 282  
info-greatbritain@eglo.com

**GREECE**

EGLO HELLAS A.E.

Sykias 2 and parodos dekeleias  
13679 Acharnai  
T: +30 21 0800 2363 | F: +30 210 240 07 29  
info-greece@eglo.com

**HUNGARY - PRODUCTION AND LOGISTICS**

EGLO MAGYARORSZAG KFT.

Fő út. 155  
3060 Paszto  
T: + 36 32 560 050 | F: +36 32 560 040  
info-hungary@eglo.com

**INDIA**

EGLO INDIA PRIVATE LIMITED

A-307, Ansal Chambers - 1, 3, Bhikaji Cama Place,  
110066 Delhi  
T: +91 85279 44288  
info-india@eglo.com

**ITALY**

EGLO ITALIANA S.R.L.

Via Giotto, 4  
31021 Mogliano Veneto (TV)  
T: +39 041 45 66 232 / -245/ -251 |  
F: +39 041 45 74 066 / -071  
info-italy@eglo.com

**KAZAKHSTAN**

EGLO KAZAKHSTAN LLP

Al-Farabi Avenue 7, Office 72, 14rd floor, Block 4A,  
Nurly-Tau Business Center  
50059 Almaty  
T: +7 727 293 25 20 | M: +7 701 031 00 00  
info-kazakhstan@eglo.com

**KOSOVO**

EGLO KOSOVA LLC

Lugisht e qytetit pn  
20000 Prizren  
T: +383 44 216 687 | SHOP: +383 49 699 100  
info-kosovo@eglo.com

**LATVIA**

MOODNE VALGUSTUS AS

Rävalapst.7  
10143 Tallinn  
T: +370 652 49923 | T: +372 667 6670  
info-latvia@eglo.com

**LITHUANIA**

MOODNE VALGUSTUS AS

Rävalapst.7  
10143 Tallinn  
T: +370 652 49923 | T: +372 667 6671  
info-latvia@eglo.com

**MAGYARORSZÁG – ÉRTÉKESÍTÉS**

EGLO LUX KFT.

Fő út. 143/A  
2120 Dunakeszi  
T: +36 27 341 353 | F: +36 27 341 409  
info-hungary@eglo.com

**MALAYSIA**

EGLO ASIA SDN BHD

No. 13, Jalan Pelukis U1/46B, Temasya 18, Glenmarie,  
40150 Shah Alam, Selangor Darul Ehsan  
T: +6011 1050 2336 | F: +603 5567 9415  
info-malaysia@eglo.com

**MEXICO**

EGLO MÉXICO ILUMINACIÓN S DE RL DE CV

Prolongación Avenida López Mateos Sur N°3561,  
Fraccionamiento Los Gavilanes  
C.P. 45645 Tlajomulco de Zúñiga | Jalisco  
T: +52 33 3687 20 95  
info-mexico@eglo.com

**MIDDLE EAST**

EGLO LIGHTING MIDDLE EAST FZE

P.O. BOX 262073, LOB6, OFFICE G18  
Jebel Ali, Dubai, UAE  
T: +97 148810080 | F: +97 148810081  
gulf@eglo.com

**MOROCCO - EGLO AFRICA**

EGLO MAGHREB LUMINAIRES SARL

219 Bd Med Zerktoouni. Suite: 67  
20330 Casablanca  
T: +212 522 98 80 25 / -05  
info-global@eglo.com | info.africa@eglo.com

**THE NETHERLANDS**

EGLO VERLICHTING NEDERLAND B.V.

Innovatiepark 20  
4906 AA Oosterhout (NBR)  
T: +31 162 48 28 30  
info.netherlands@eglo.com

**NORWAY**

MS Belysning AS

Heiaveien 4  
1900 Fetstund  
T: +47 63 888500 | F: +47 63 888501  
info-norway@eglo.com

**PERU**

EGLO PERU S.A.C

Av Primavera 1419  
Distrito de Santiago de Surco y Departamento de Lima  
T: +51 902 763 635  
info-peru@eglo.com

**POLAND**

EGLO POLSKA SP. Z O.O.

Ul. Dźwiękowa 2  
02-857 Warszawa  
T: +48 22 644 57 55 | F: +48 22 644 89 82  
info-poland@eglo.com

**PORTUGAL**

EGLO PORTUGAL ILUMINAÇÃO, LDA

Rua Fonte Parada, 125  
4595-434 Seroa-Paços de Ferreira  
T: +351 255 890 000 | F: +351 255 892 346  
info-portugal@eglo.com

**ROMANIA**

EGLO ROMANIA PRODEXIM SRL.

Str. Atomistilor nr. 1D  
77125 Magurele - Ilfov  
T: +40 314 250 902 | F: +40 314 250 899  
info-romania@eglo.com

**RUSSIA**

EGLO LIGHTING LLC

Varshavskoe shosse 3 | Office 23  
117105 Moscow  
T: +7495 789 4311 | F: +7495 789 4312  
info-russia@eglo.com

**SERBIA**

EGLO RASVETA DOO

Stefana Prvovenčanog 28  
11000 Beograd  
T: +381 11 3981 366 | F: +381 11 3981 389  
info-serbia@eglo.com

**SLOVAKIA**

EGLO CZ+SK s.r.o

Náchodská 2479/63  
193 00 Praha 9 Horní Počernice  
T: +421 313 211 551 | F: +421 313 211 556  
info-slovakia@eglo.com

**SLOVENIA**

EGLO RASVJETA D.O.O.

Jadranska avenija 9a  
10000 Zagreb  
T: +386 158 093 18  
info-slovenia@eglo.com

**SPAIN**

EGLO ESPAÑA ILUMINACION S.L.

Avda. de Castilla 1 (Edf. Best Point) 2º-16A  
28830 San Fernando de Henares, Madrid  
T: +34 91 677 9044 | F: +34 91 677 0304  
info-spain@eglo.com

**SWEDEN**

EGLO SVERIGE AB

Star Street 1  
512 50 Svenljunga  
T: +46 340 623 505 | F: +46 340 623 605  
info-sweden@eglo.com

**SWITZERLAND**

EGLO SCHWEIZ AG

Seetalstraße 142  
6032 Emmen  
T: +41 41 268 69 59 | F: +41 41 268 69 58  
info-switzerland@eglo.com

**TURKEY**

EGLO Aydınlatma ithalat ihracat Ltd. Şti.

Eyüp Sultan Mah. Sekmen Cad. No:18/2  
34855 Sancaktepe / Istanbul Samandira  
T: +90 216 311 09 -02 / -03 / -04 |  
F: +90 216 311 09 / -05  
info-turkey@eglo.com

**UKRAINE**

EGLO UKRAINE LTD

Vatslava Gavela boulevard, 6/7-A,  
03124 Kyiv  
T: +38 044 463 98 41 | F: +38 044 468 84 67  
info-ukraina@eglo.com

**USA**



















EGLO USA, INC.

3640 Royal South Parkway  
30349 Atlanta, Georgia  
T: +1 404 477 5601 | F: +1 404 393 7053  
info-usa@eglo.com



























































# LEGEND

## PICTOGRAM / PIKTOGRAMME / PICTOGRAMME

### SOCKETS FASSUNGEN DOUILLES

 LED	 G4	 G53
 2G7	 G5	 GU5,3 / MR16
 2G11	 G9	 GU10
 2GX13	 G10Q	 GX53
 E14	 G13	 GY6,35
 E27	 G23	 R7s

### BULBS LEUCHTMITTEL AMPOULES

 E14 / C35	 E27 / A60 Halogen	 E27 / E140 Filament
 E14 / C35f	 E27 / R63 Halogen	 E27 / PS160 Filament
 E14 / D45	 E27 / A60 LED	 E27 / T30 Filament
 E14 / C35f LED	 E27 / A60 Filament	 E27 / T32 Filament
 E14 / D45 Halogen	 E27 / A65 LED	 G4 / T9
 E14 / C35 Halogen	 E27 / A75 Filament	 G4 / LT9
 E14 / T22	 E27 / G45 LED	 G4 / LT14
 E14 / C35 Filament	 E27 / G45 Filament	 G9
 E14 / C37 Filament	 E27 / G80 Filament	 G9 LED
 E14 / C35f Filament	 E27 / G95	 GU10
 E14 / C37f Filament	 E27 / G95 Filament	 GU10 LED
 E14 / P45 LED	 E27 / G125	 GU10 SMD LED
 E14 / P45 Filament	 E27 / G95 LED	 GX53 / LF75
 E14 / P50	 E27 / G200 Filament	<b>LED</b> LED board / LED Platine / LED bord
 E14 / ST48 Filament	 E27 / R63 LED	 MR16
 E14 / ST64 Filament	 E27 / ST48 Filament	 MR16 LED
 E14 / T20 LED	 E27 / ST64 Filament	 R7s / 78mm
 E27 / A60	 E27 / B80 Filament	 R7s / 118mm
 E27 / G90	 E27 / BR150 Filament	 R7s / 78mm LED
 E27 / QR63	 E27 / DP165 Filament	 R7s / 118mm LED

**LIGHT COLOUR & LUMEN**  
**LICHTFARBE & LUMEN**  
**COULEUR LUMINEUX & LUMEN**

The colours of the LED are represented as pictogrammes (see below), their luminous flux directly beneath. The luminous flux is quoted in lumen and describes the amount of light generated by the LED. The higher the value, the brighter is the lamp. Lumens are LED boards and are the light measurement value in bulbs.

Die Farben der LED werden als Piktogramm (siehe unten) dargestellt, deren Lichtstrom direkt darunter. Der Lichtstrom wird in Lumen gemessen und gibt die erzeugte Lichtmenge der LED an. Je höher der Wert, desto heller das Produkt. Lichtstromangaben (Lumen) sind Platinen- bzw. Leuchtmittelwerte.

Les couleurs de LED ont représentés sous forme de pictogrammes, leur flux lumineux directement en dessous. L'unité de flux lumineux est le lumen et il mesure la quantité de lumière générée par les LED. Plus la valeur est élevée, plus la lampe est lumineuse. Les lumens sont l'unité de mesure de l'intensité lumineuse des ampoules et des panneaux led intégrés.

	RGB RGB RGB		RGB + tunable white RGB + tunable white RGB + tunable white
	RGB + white RGB + weiß RGB + blanc		tunable white tunable white tunable white
	RGB + warmwhite RGB + warmweiß RGB + blanc chaud		warm white warmweiß blanc chaud
	RGB + coldwhite RGB + kaltweiß RGB + blanc froid		cold white kaltweiß blanc froid
	RGB + neutralwhite RGB + neutralweiß RGB + blanc neutrale		neutral white neutralweiß blanc neutre

**SWITCHES & SENSORS**  
**SCHALTER & SENSOREN**  
**INTERRUPTEUR & CAPTEURS**

	incl. cable & plug inkl. Kabel & Stecker câble & connecteur inclus		pedal switch Trittschalter interrupteur à pied		swedish plug Stecker Schweden connecteur swede
	internal dimmer eingebauter Dimmer variateur intégré		cable switch Kabelschalter interrupteur à câble		"Touch me" ON/OFF "Touch me" EIN/AUS "Touch me" ON/OFF
	button switch Druckknopf interrupteur de pression		incl. cable & plug transformer inkl. Kabel & Stecktransformator câble & transformateur à prise		"Touch me" ON/OFF & dimm "Touch me" EIN/AUS & Dimmen "Touch me" ON/OFF & graduable
	function switch Funktionsschalter interrupteur fonction		remote control Fernbedienung télécommande		pull switch Zugschalter interrupteur à bascule
	rocker switch Wippschalter interrupteur à bascule		Day & Night Sensor Tag & Nacht Sensor sensor jour & nuit		Timer - automatic on/off Zeitschaltuhr - automatisches Ein- & Ausschalten minuterie - peut être éteint et allumé automatiquement
	pedal dimmer Trittdimmer variateur à pied		sensor Sensor sensor		

**FUNKTIONS & COMFORT**  
**FUNKTIONEN & KOMFORT**  
**FONCTIONS & CONFORT**

	incl. battery inkl. Akku incl. pile		cutout (in mm) Ausschnitt (in mm) perçage du panneau (en mm)		packaging / delivery unit Verpackungs- / Liefereinheit unité d'emballage / de livraison
	incl. battery inkl. Batterie incl. pile		dimmmable dimmmbar mit externen Dimmer graduable		shortable kürzbar réductible
	battery specifications Batteriespezifikationen spécifications des piles		not dimmmable nicht dimmmbar ne pas graduable		Voltage Volt Voltage
	beam angle Ausstrahlwinkel angle de rayonnement		Can be operated via control unit Bedienbar über Steuergerät Peut être commandé par une unité de contrôle		Watt
	corner mount possible Eckmontage möglich montage en coin possible		replaceable LED austauschbare LED LED remplaçables		USB connection USB-Anschluss Connexion USB
	Colour Rendering Index		loadable in kg belastbar in kg chargeable en kg		Qi-Charger

**PROTECTION CLASS**  
**SCHUTZKLASSE**  
**CLASSE DE PROTECTION**

The protection class indicates to what extent the lamp is protected against electric shock. All lamps in this catalogue are at least protected with the protection class 1 - a higher class is specified in the information box of the respective lamp.

Die Schutzklasse gibt an, inwiefern ein Produkt gegen einen elektrischen Schlag gesichert ist. Alle Leuchten in diesem Katalog sind mit mindestens Schutzklasse 1 gesichert, bei höheren Klassen wird das Symbol im Infokasten der Leuchte angegeben.

La classe de protection indique, dans quelle mesure la lampe est protégée contre les chocs électriques. Tous les lampes dans ce catalogue sont protégées au moins avec la classe 1 - une classe plus élevée est indiquée dans l'information de la lampe.

	protection class 1: protective earthing Schutzklasse 1: Schutzerdung classe de protection 1: prise de terre		protection class 2: protective insulation Schutzklasse 2: Schutzisolation classe de protection 2: double isolation ou renforcée		protection class 3: protective low voltage Schutzklasse 3: Schutzkleinspannung classe de protection 3: très basse tension de sécurité
--	---	--	---	--	---

**PROTECTION RATING**  
**SCHUTZGRAD**  
**INDICE DE PROTECTION**

The protection rating ensures the operational safety of luminaires. The first number specifies the extent of the protection against the ingress of foreign bodies; the second number identifies the humidity protection grade. All luminaires in this catalogue are at least protected with the rating IP20 - a higher rating is specified in the information box of the luminaire.

Der Schutzgrad gewährleistet die Betriebssicherheit von Leuchten. Die erste Ziffer des IP Grades beschreibt den Schutzbereich gegen das Eindringen von Fremdkörpern, die zweite Ziffer informiert über den Grad des Feuchtigkeitsschutzes. Alle Leuchten in diesem Katalog sind mit mindestens Schutzgrad IP20 gesichert, bei höheren Graden wird das Symbol im Infokasten der Leuchte angegeben.

L'indice de protection assure la sécurité opérationnelle des luminaires. Le premier chiffre indique à quel point la protection est efficace contre l'insertion de corps étrangers; le second chiffre indique quant à lui le degré de protection par rapport à l'humidité. Tous les luminaires dans ce catalogue sont protégés au moins avec l'indice IP20 - un indice plus élevé est indiqué dans l'information d'article.

	IP33		IP44		IP54		IP65		IP67
--	------	--	------	--	------	--	------	--	------

# REGISTER

SERIES NAMES  
SERIENNAMEN  
NOME DE PRODUITS

name name nom	page seite page	name name nom	page seite page	name name nom	page seite page	name name nom	page seite page
AGOLADA	85	CHIAPPERA	125	HILBURN 1	148	NISIA	58
ALAMONTE	130,135	CHINOA	109	IPHIAS 2	64-65	NISIA-Z	28
ALAMONTE 1	130-132	CISTIerna	97	JABAGA	100	NIVAROLO	70
ALAMONTE 3	128-129	CISTIerna 2	97	JORBA	105	ONCALA	59
ALBACETE	152	CITY	116-117	KIBEA	73	ONJA	118
ALGHERA	210	CONNECT Z	24	LADUNARA	208	PAGINO	172
ALORIA	154-156	CONNECT-Z SENSOR	24	LAMEDO	190	PALIZZI	229
ARACENA	193	CONNECTOR BOX	201	LAMOZZO	226	PALOSCO	45
ARGOLIS 2	64-65	CORBEZZOLA	224-225	LAMOZZO 1	226	PARK	110
ARGOLIS-Z	26	CORNALe	72	LATERNA 4	164-165,168	PARK 4	200-201
ATOLLARI	96	COSTORIO	94	LATERNA 5	166,169	PARTAJ	216
AZZINANO	74	CUBA	202	LESMO	101	PASSIRANO	109
BARACCONI	224	CUBONE	216	LIBISA	218	PASTION	229
BARROSELA	147,150	CULPINA	72	LISIO	140-141	PERNATE	80
BASALGO 1	59	DESELLA 1	105	LM_LED_E27	32	POLIENTO	59
BASALGO-Z	27	DETECT ME 1	186,189	LM_LED_GU10	32	PORRASSA	227
BELCREDA	118	DETECT ME 3	186,189	MADRIZ	62	PRATA VECCHIA	51
BEVERLY	86	DETECT ME 5	187	MANFRIA	40	PREDAZZO	84
BEVERLY 1	87	DETECT ME 6	186,189	MANNERA	206-207	PULFERO	146
BITETTO	94	DONATORI	50	MARGO	196	PULFERO 1	152
BOSARO	87	DONINNI 1	42-43	MARTANO	225	RAVELLO	136-137
BOTTONA	210	ENTRIMO	147	MARUGGIO	103	REDONDO	82
BOVOLONE	144	EREDITA	73	MELGOA	146,150	RIFORANO	38-39
BREGANZO	113	EREMITANA	100	MELZO	46	RIGA	88-89
BREGANZO 1	113	EREMITANA-Z	27	MILTON	149-150	RIGA 3	190
BRIANZA	44	FAEDO 3	178-185	MIRANDOLA	135	RIGA 5	92-93
BUDRONE	127	FAEDO 4	176-177	MONREALE	145	RIGA-LED	90
BUFALATA	95	FANDINA	76	MONTEROLLO SMOKE	214	ROBLEDO	86
CALDIERO	52	FARINDOLA	71	MONTEROLO	212-213	RONCO	66
CALPINO	104	FIUMICINO	48-49	MONTEROLO-Z	30-31	RUBIO	60
CALPINO 2	104	FLATNEONLED	220-221	MORINO	82	SAKEDA	105
CAMARDA	106-107	FORNACI	70	MUSSOTTO	110	SALITTA	79,192
CANOVE	146	FOSSOMBRONE	208	NAVEDO	158-163	SALVANESCO	69
CARRARO	124	FROSOLONE	218	NEMA	175	SAN TELMO	153
CASABAS	228	FUSIGNANO	208	NEMA 1	176	SELINUS	137
CASAZZA	62-63	GORZANO	80	NEMA-Z	27	SERRICELLA	76
CASCINETTA	132-133	HELSINKI	56-57	NEMBRO	40	SESIMBA 1	98
CERNO	114-115	HILBURN	148	NINNARELLA	55	SIDNEY	139

name name nom	page seite page
SIRMIONE	138
SITIA	74
SONCINO	135
SONELLA	66
SORRONARO	61
SPIAZZINA	84
SPINETOLI	175
SPINETOLI 2	219
SPONGANO	102
STAGNONE	53
STOCKHOLM 1	86
TAPARITA	79
TAVERNA	142
TONEGO	90
TRECATE	144
TREVILO	98
TRIBANO	113
TRONO STICK	87
TRONTO	191
UGENTO	78
UTRERA	227
VALDEO	144,152
VENTO 1	69
VENTO 2	69
VERRES	110
VIGNANELLO	215
VILLAGRAPPA	228
VILLAGRAZIA	108
ZIMBA	194
ZIMBA-LED	194



# REGISTER

ARTICLE NUMBER

ARTIKELNUMMER

NUMÉROS D'ARTICLE

Number nummer Numéro	page seite page	Number nummer Numéro	page seite page	Number nummer Numéro	page seite page	Number nummer Numéro	page seite page	Number nummer Numéro	page seite page	Number nummer Numéro	page seite page	Number nummer Numéro	page seite page
12251	32	88139	117	94101	89	96452	189	98121	145	98758	226	900209	215
12253	32	88142	116	94102	89	96454	186	98123	145	99099	24	900211	215
22144	168	88144	116	94103	88	96505	90	98148	48	99106	24	900212	218
22145	168	88152	202	94105	89	97119	90	98149	48	99521	62	900213	216
22462	166	88153	202	94106	88	97146	52	98151	48	99522	63	900215	216
22463	166	88489	149	94107	88	97159	74	98152	49	99533	63	900219	220
22464	166	88575	194	94111	175	97218	110	98153	108	99534	63	900221	220
22466	169	88744	202	94121	69	97222	80	98154	108	99565	115	900222	221
22467	164	89767	118	94128	87	97226	146	98176	172	99566	115	900223	220
22468	165	89768	118	94138	113	97238	110	98178	172	99567	117	900224	221
22469	165	90184	153	94278	59	97241	104	98182	191	99568	117	900238	216
22471	165	90748	200	94779	87	97242	104	98184	175	99569	92	900239	218
22472	168	91206	201	94788	132	97261	144	98185	177	99571	92	900243	224
22995	169	91207	201	94792	146	97284	113	98187	229	99572	60	900244	225
22996	169	92736	90	94799	87	97285	138	98191	229	99573	60	900245	224
30184	140	93095	156	94803	85	97287	138	98195	228	99574	193	900246	224
30185	140	93097	154	94804	85	97288	138	98196	228	99576	193	900247	228
30187	141	93098	154	94805	147	97289	72	98266	42	99577	193	900255	226
30188	140	93099	155	94827	135	97294	135	98269	42	99578	61	900256	179
30191	114	93254	73	94831	130	97296	144	98271	42	99579	61	900257	181
30192	114	93268	86	94832	130	97303	46	98272	43	99583	62	900258	27
30205	58	93318	82	94833	132	97304	46	98273	131	99584	62	900259	208
30206	58	93319	82	94841	146	97307	80	98701	50	99585	73	900261	79
30207	58	93368	82	94842	148	97308	80	98702	50	99586	142	900262	79
32898	93	93384	176	94843	148	97312	118	98703	50	99587	130	900263	192
32899	93	93385	176	94855	152	97419	187	98705	69	99598	142	900264	192
33152	182	93403	156	94858	150	97421	189	98707	44	110186	198	900265	28
33153	182	93407	154	94863	150	97422	186	98708	44	110187	198	900266	28
33154	182	93408	155	94866	148	97451	52	98709	109	110189	198	900267	28
33155	183	93426	201	94871	66	97455	178	98711	109	900117	219	900268	30
33156	184	93445	161	94872	66	97456	178	98713	132	900118	76	900269	31
33157	184	93446	160	95016	59	97457	178	98714	133	900119	76	900271	30
33158	184	93447	160	95097	105	97458	179	98715	133	900121	27	900272	30
33159	185	93448	160	95233	194	97459	180	98719	135	900122	208	900275	100
48944	227	93452	162	95235	194	97461	180	98721	136	900123	208	900276	100
48968	227	93454	163	95982	59	97462	180	98722	136	900124	26	900277	65
81751	56	93455	159	95987	74	97463	181	98723	136	900125	26	900278	64
81752	57	93456	158	95988	74	97464	189	98724	137	900126	26	900279	65
81753	56	93457	158	96013	86	97465	186	98725	38	900131	27	900281	64
82309	116	93458	158	96018	113	97471	176	98726	39	900132	84	900282	65
83278	56	93459	159	96021	98	97632	46	98727	38	900133	76	900283	64
83279	57	93462	159	96207	147	98085	97	98728	38	900136	129	900284	97
83281	57	93463	162	96239	144	98086	97	98729	109	900137	128	900285	124
83433	110	93464	162	96241	152	98088	72	98731	51	900138	128	900286	124
83589	150	93465	163	96256	105	98096	40	98737	45	900139	128	900287	125
83966	139	93481	190	96262	152	98097	40	98738	45	900189	100	900288	127
83971	139	93482	190	96276	96	98101	212	98746	98	900201	214	900289	127
86189	190	93994	84	96277	96	98102	212	98747	98	900202	214	900291	94
86541	86	94092	196	96287	105	98103	212	98751	40	900203	214	900292	101
87105	139	94093	196	96365	69	98104	213	98757	226	900208	215	900294	210



Number  
number  
Numéro

page  
seite  
page

900295	210
900296	210
900297	66
900299	218
900445	104
900457	206
900458	207
900459	207
900461	207
900669	95
900671	95
900672	137
900673	70
900674	70
900675	70
900679	94
900681	79
900682	71
900684	137
900688	55
900689	55
900691	53
900692	53
900698	131
900709	78
900802	125
900803	125
900804	225
900805	225
900807	106
900808	106
900809	106
900811	107
900885	102
900886	102
900887	102
900888	103
900889	103
900891	103



All previous catalogues and price lists are no longer valid with the issue of this catalogue. Errors, misprints, model and price changes and technical modifications are reserved. We deliver based on our terms of delivery and payment. Our products comply with the European light norm EN60598. Products with the ENEC test mark are conforming to the guide line 2006/95/EG. Products with additional safety remarks (e.g protection class, IP) are identified within the product family with the relevant symbol and number. The content of this catalogue is protected under copyright law for EGLO Leuchten GmbH. All rights reserved. Our specific written consent must be obtained before using any illustrations and texts. The pictures are 4C prints and may differ from the original.

The product pictures and ambiances in this catalogue can deviate from reality, and they do not necessarily concur with the usual application of the product. EGLO does not assume liability for the correctness, completeness or the application depiction of the products and/or the product information.

Design, layout and composition: EGLO Leuchten GmbH, A-6136 Pöchlarn - AUSTRIA

Print: Samson Druck GmbH, 5581 St. Margarethen - AUSTRIA

Pictures: EGLO, Star Trading, Adobe Stock, istockphoto.com

---

Mit diesem Katalog verlieren alle vorhergehenden Kataloge und Preislisten ihre Gültigkeit. Irrtümer, Druckfehler, Modell- und Preisänderungen sowie technische Änderungen vorbehalten. Wir liefern zu unseren Liefer- und Zahlungsbedingungen. Unsere Produkte entsprechen der europäischen Leuchtennorm EN 60598. Produkte mit dem ENEC Prüfzeichen sind konform mit der Richtlinie 2006/95/EG. Produkte mit weiteren Sicherheitshinweisen (zB. Schutzklasse, IP) sind mit Symbol und Zahl bei der Produktfamilie ausgezeichnet. Der Inhalt dieses Kataloges ist für die EGLO Leuchten GmbH urheberrechtlich geschützt. Alle Rechte sind vorbehalten. Bilder und Texte dürfen nicht ohne vorherige ausdrückliche, schriftliche Genehmigung verwendet werden. Die Abbildungen sind 4C Drucke und können vom Original abweichen.

Die Katalogbilder und die gezeigten Darstellungen der Produkte können von der Wirklichkeit abweichen und nicht den üblichen Produktanwendungen entsprechen. EGLO übernimmt keine Haftung für die Richtigkeit, Vollständigkeit und Anwendungsdarstellung der Produkte und Produktinformationen.

Gestaltung, Layout und Satz: EGLO Leuchten GmbH, A-6136 Pöchlarn - AUSTRIA

Druck: Samson Druck GmbH, 5581 St. Margarethen - AUSTRIA

Bilder: EGLO, Star Trading, Adobe Stock, istockphoto.com

---

Le présent catalogue remplace tous les catalogues et tarifs précédents. Sous réserve d'erreurs, de fautes d'impression, de modification des modèles et de changement de prix et de technique. Nous livrons sur la base de nos conditions de livraison et de paiement. Nos produits sont conformes aux normes européennes EN 60598 et portent le marquage CE. Les produits portant la marque ENEC sont conformes à la Directive 2006/95/EG. Les produits portant d'autres indications de sécurité (par exemple classe de protection, IP) sont identifiés par le symbole et le nombre correspondants dans la famille de produits.

Le contenu du présent catalogue est protégé pour la société EGLO Leuchten GmbH par un copyright. Tous droits réservés. Toute reproduction d'images et de texte est interdite sans autorisation explicite par écrit préalable. Les images sont imprimées en 4C et peuvent différer de l'original.

Les images des produits et les ambiances dans le catalogue peuvent dévier de la réalité et ne sont pas nécessairement en ligne avec l'usage habituel du produit. EGLO n'engage pas sa responsabilité sur la justesse des images et sur les informations relatives à l'usage pouvant être fait des produits.

Conception, maquette et composition: EGLO Leuchten GmbH, A-6136 Pöchlarn

Presse: Samson Druck GmbH, 5581 St. Margarethen - AUSTRIA

Images: EGLO, Star Trading, Adobe Stock, istockphoto.com

11-2022





EGLO Leuchten GmbH  
Heiligkreuz 22  
A-6136 Pill  
Austria  
Tel. +43 (0) 5242 6996  
Fax +43 (0) 5242 6996-972  
info@eglo.com  
www.eglo.com

---

KATA23



my light | my style