

JUNG

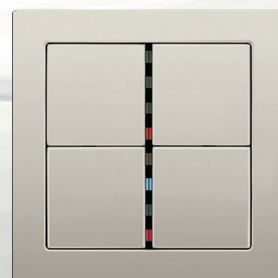

JUNG Bus
A 2-wire System





JUNG Bus

The JUNG Bus is a trendsetting installation solution for private apartments, hotels or even larger buildings. The system offers an easy way to realise bus-type comfort functions. A clear benefit is the simple installation of the central devices Relay station universal and the Dimming station. Lighting, blinds and shutters can be controlled simultaneously with the Sensor Module or the Push-button Module to suit individual requirements.

Feature overview: Switching, Dimming, Blinds control, Central ON/OFF function, Light scene functions, Hotel card control with delayed light fading, simple 2-wire installation, no special software required, sensory touch with 16 switching points, individual layouts of sensory surface, Flat push-buttons in various selections



Sensitive switching and individual design

Sensor Modules

The sensory switching surface of the Sensor Module offers the possibility of freely creating a switch and design an individual object. If required, the front can be fitted with a photo of the room, a stylised drawing or simply text. The required background is inserted cleanly and securely behind a transparent cover. Just the tip of a finger for less than a second is enough to switch a function as lighting, blinds or shutter control, light scenes and central functions.

Systematics

The surface is divided into 16 freely selectable switching points. Each can be used separately or arranged into eight different groups, e.g. regarding the inserted photo or drawing. All switching points are backlit with an LED. As soon as a switching point is touched, a signal tone reports the successful activation.

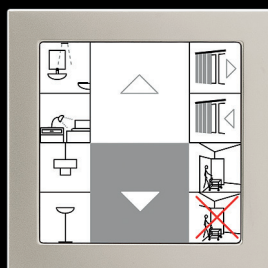

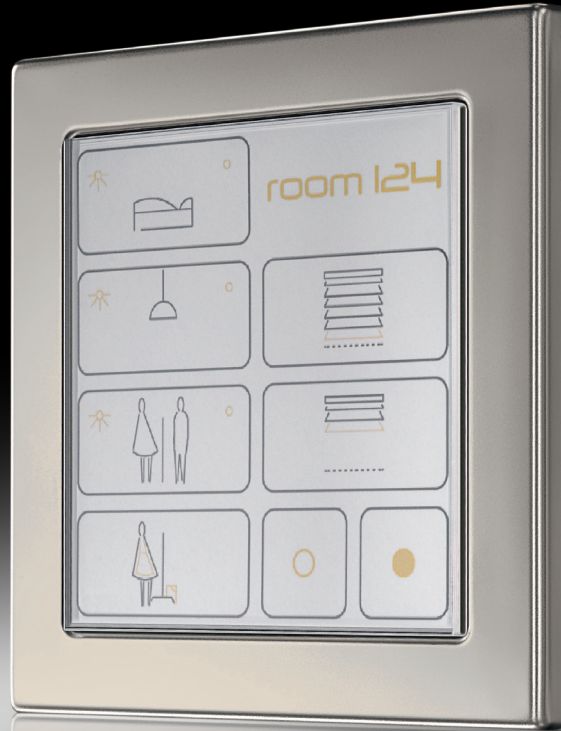

Installation

The sensor module is exclusively connected to the Universal Relay Station. The installation is logically organised. First the special supporting frame is mounted on the flush-box before the design frame and the module is latched onto the supporting frame. Additionally the device can be secured against dismantling with two screws.



Transparent cover



Individual element

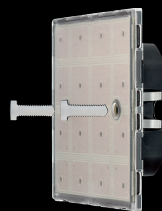

Sensor Module



Design frame



Supporting frame



Acreation in white



LS 990 in white



CD 500 in white

2-wire Push-button Module

Optimum operation with the large buttons offer the new Push-button Modules from JUNG. Available in the A-, CD- and LS ranges the modules enable the control of the Relay Station or Dimming Station with only 2 wires. The Push-button Module can be extended with the Universal Extension Module. This combination allows the control of 16 channels of 2 parallel Relay Stations to operate lighting and blind systems.

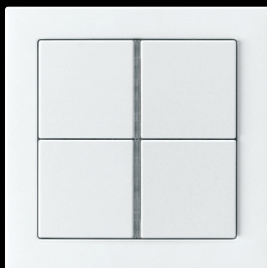

Flat Design in white

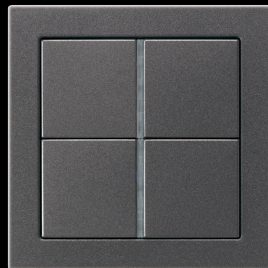

Flat Design in anthracite



Flat Design in aluminium

Dimming Station

The new Universal Dimming Station has four channels available for switching and dimming the lighting. It offers all the features of a JUNG dimmer, including a memory function for the brightness value. When switching off the lighting, the so-called dimming down function can be used. The Dimming Station can also be operated via the integrated keypad without needing to connect a control device. This offers considerable benefits when commissioning. It is generally possible to connect two Dimming Stations in parallel in order to extend the number of channels. If the blinds or shutters should also be regulated, the Dimming Station can easily be connected in parallel with the Universal Relay Station.

Hotel card switch terminal

The connection of hotel card switches to the Dimming Station is likewise possible: after inserting the key card, the room lighting is automatically switched on as a central function. If the key card is removed, the lighting remains switched on for one minute and the Dimming Station can continue to be operated. This is followed by a dimming down phase during which the lighting is dimmed down to the minimum brightness level within an adjustable time and is then switched off.



Hotel card switch

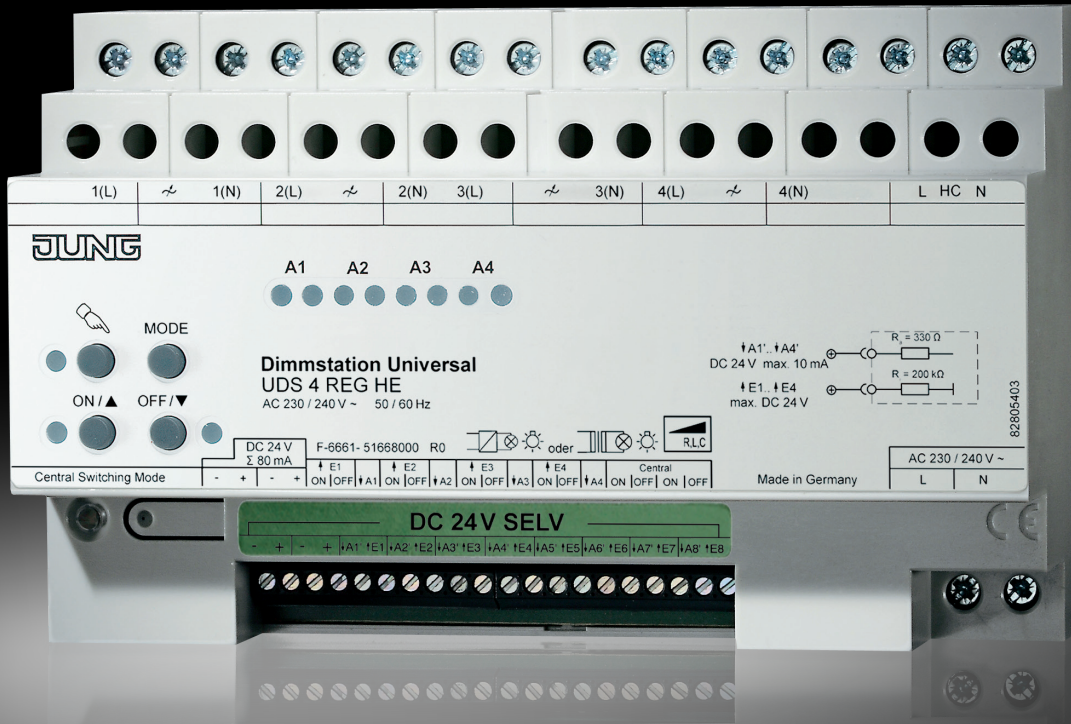

Control devices

The functions of the Universal Dimming Station are controlled in the JUNG bus via Sensor Modules or Push-button Modules. For individual channel control, it is possible to connect conventional push-button sensors via direct wiring. All these operating elements enable the dimming process to be carried out in “2 surface mode”; this means that one button controls the functions “Brighter/ON” while the other controls the functions “Darker/OFF”.

Multifunctional use

Simple installation and selective control of room functions

The new JUNG Bus consists of just a few devices to realise convenient room functions. Within this system, the devices Sensor Module and Push-button Module control the JUNG Relay and Dimming Station and enable the regulation of lighting and the control of shutter, blinds or curtains. Light scenes and central functions complete the system. Only 2 wires are required for the installation of this new technology.



Sensor Module



Push-button Module
with extension unit

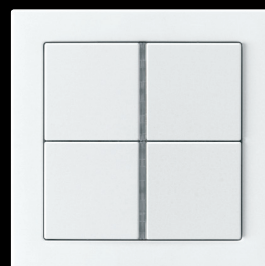

Push-button Module
„JUNG 2-wire bus“

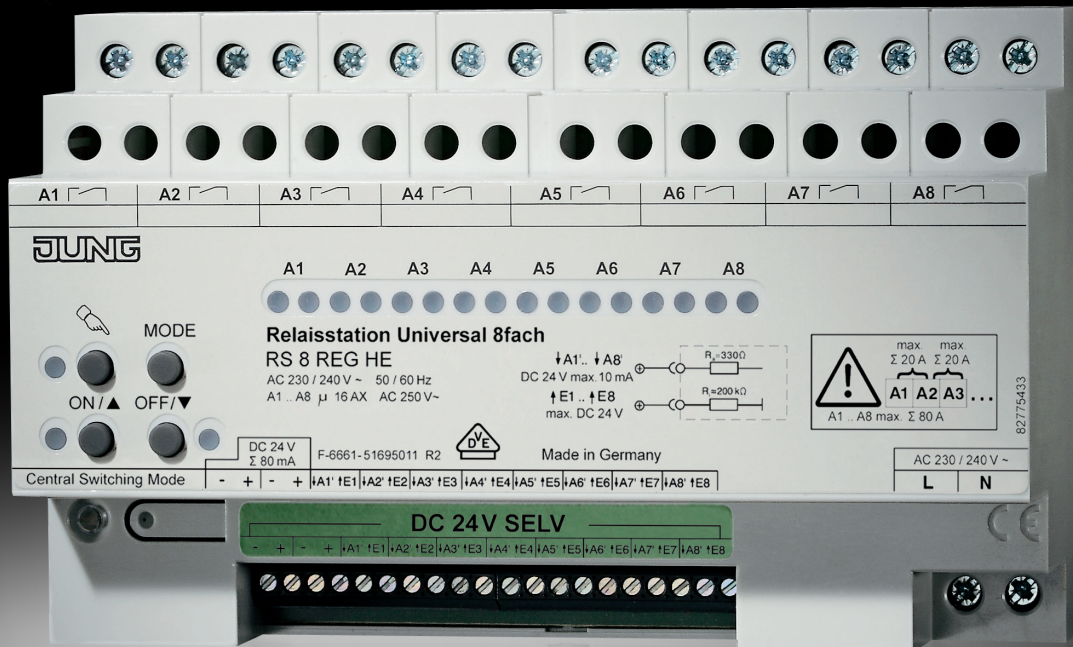

Relay Station

The eight channels of the Universal Relay Station offer high performance with hardly any space requirement. In combination with the Sensor Module or the new Push-button Modules the Relay Station enables the operation of lighting, blinds, shutters and the central switching function "All ON, All OFF". In addition to the control via the 2-wire technology each channel can also be triggered with simple push-button make contacts e.g. the conventional 24 V push-button sensors. Two Relay Stations can be connected in parallel. Practical for commissioning: The Relay Station enables the manual operation via the integrated keypad without needing to connect control units. Status LEDs indicate the respective operation mode.

Connection of 4 control units to the Universal Relay Station

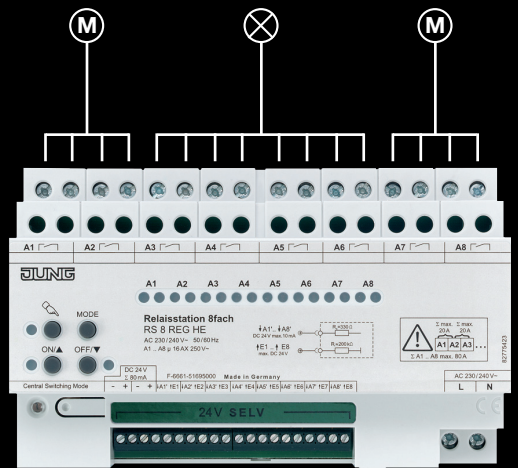

AC 230 V~

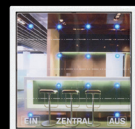

Sensor Module for the sensitive control of room functions

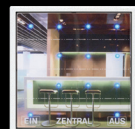

Sensor Module for the sensitive control of room functions



2-wire Push-button Module for switching and dimming the lighting

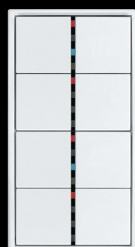

Push-button Module with extension unit

Parallel connection of Relay & Dimming Station

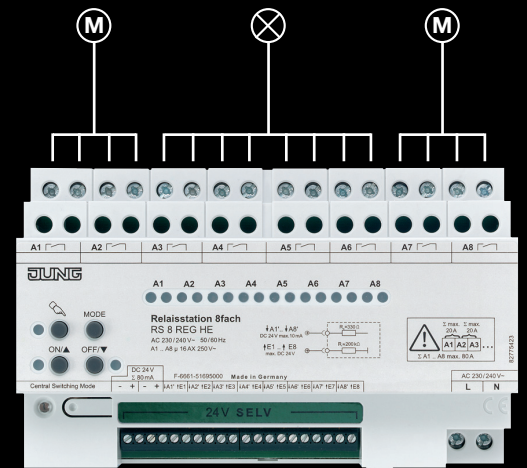

AC 230 V~



Sensor Module for the sensitive control of room functions



Sensor Module for the sensitive control of room functions



2-wire Push-button Module for switching and dimming the lighting

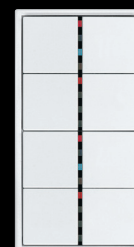

Push-button Module with extension unit

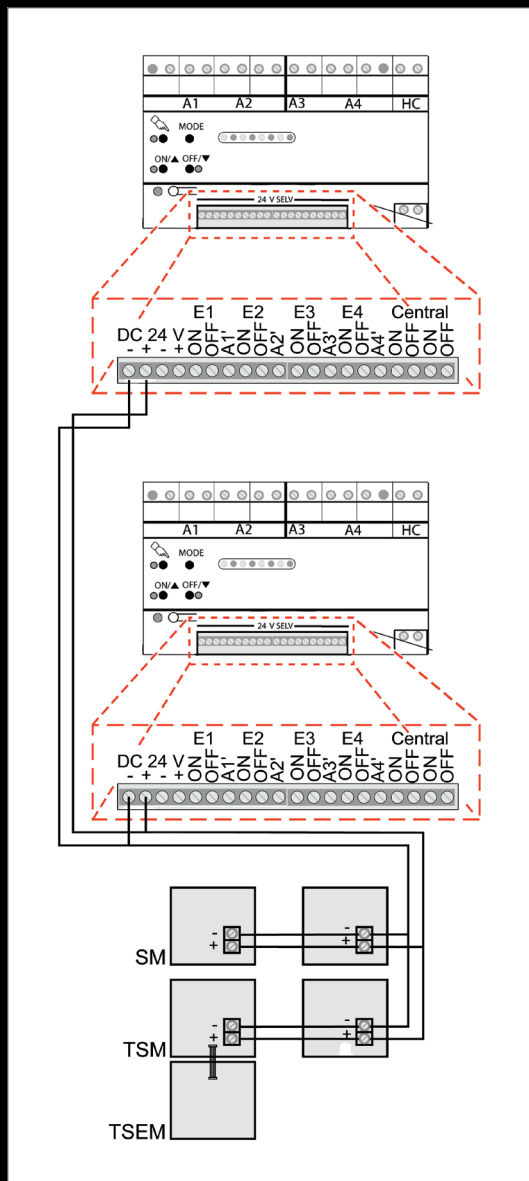
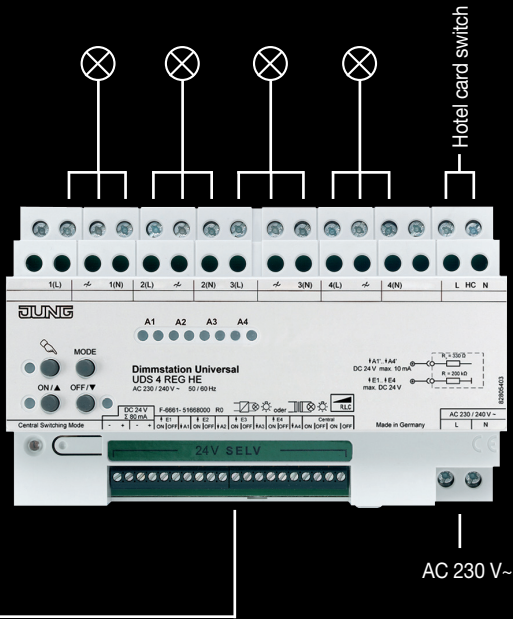

Wiring example of two Universal Dimming Stations with two sensor modules, a push-button module and a push-button module with extension unit. Simply connected via two wires.

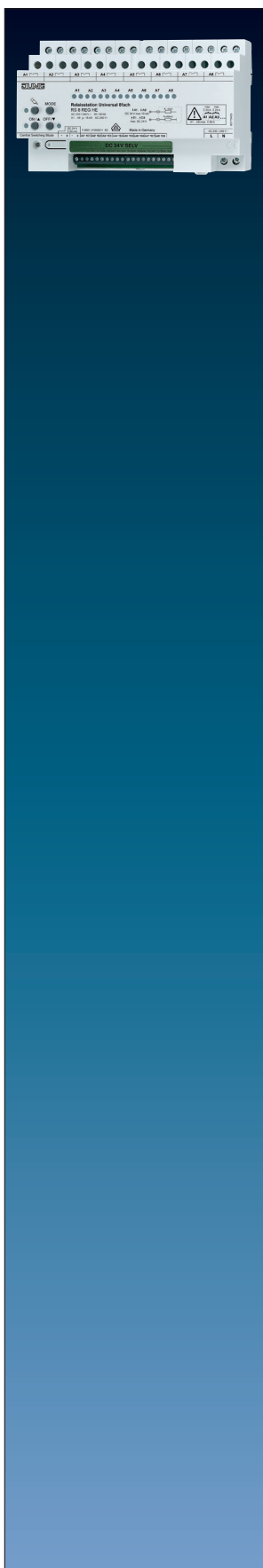

	Ref.-no.
Relay station universal, 8-gang	RS 8 REGHE
Rail mounting device, 8 units with manual electronic operation and LED status indication 8 make contacts	
Designated use	
<ul style="list-style-type: none"> • for switching and push-button control of electrical loads AC 230/240 V (floating contacts) • for the control of blinds, shutters, awnings and similar hangings • Operation by means of push-button sensors, sensor modules or unlit installation buttons 	
Product features	
<ul style="list-style-type: none"> • Local control. The relay station can be controlled using the keypad when the control units are not connected. • Activation of status LEDs on the control units. The relay station has the activation outputs A1'...A8' for this purpose. • 8 floating contacts for switching, push-button control and movement of e.g. blinds • Venetian blind operation with slat adjustment • Mixed operation of switching, push-button and venetian blind control is possible. • Central switching function All On, All Off 	
Technical Data	
Rated voltage:	AC 230/240 V ~, 50/60 Hz
Power loss:	12.5 W
Stand-by power:	0.5 W
Length of control cable:	max. 100 m
Number of control units	
Sensor module (ref.-no. SM 1608) or push-button module (4008 TSM):	max. 4 (also when relay/dimming stations are connected in parallel)
Push-button sensors 24 V AC/DC (make):	depending on push-button sensor, consider current consumption
Control units	
Voltage:	DC 24 V SELV
Max. admissible current:	Σ 80 mA
Switching inputs E1 ... E8	
Internal resistance:	Ri = 200 kΩ
Control voltage:	DC 24 V SELV
Activation outputs A1' ... A8'	
Resistance:	Ra = 330 Ω
Control voltage:	DC 24 V SELV
Max. admissible current:	10 mA
Wiring, mains and load outputs	screw terminals single wire: 1.5 ... 4 mm ² <ul style="list-style-type: none"> • stranded without ferrule: 0.75 ... 4 mm² • stranded with ferrule: 0.5 ... 2.5 mm²
Wiring of switching inputs, activation outputs and control units:	screw terminals single wire: 1.5 mm ² <ul style="list-style-type: none"> • stranded without ferrule: 1.0 mm² • stranded with ferrule: 0.75 mm²
Load outputs A1 ... A8	
Contact type:	floating make contact (μ contact)
Breaking capacity per load output:	AC 250 V ~ / 16 AX
Switching current load outputs:	Σ 80 A
Switching current neighbouring load outputs:	Σ 20 A
Loads per output	
ohmic load:	3000 W
capacitive load:	16 A, max. 140 μF
blind / fan motors:	1380 VA

Starting current: max. 800 A (200 μ s)
 max. 165 A (20 ms)

Lamp loads

Incandescent lamps: 3000 W
 HV halogen lamps: 2500 W
 LV halogen lamps with:
 - TRONIC transformer: 1500 W
 - conventional transformer: 1200 W

Fluorescent lamps:

- non-compensated: 1000 W
 - parallel compensated: 1160 W (140 μ F)
 - lead-lag circuit: 2300 W (140 μ F)
 Electronic ballast: depending on type

Minimum load: AC 12 V, 100 mA

Ambient temperature: -5 °C ... +45 °C

Storing temperature: -25 °C ... +70 °C

Mounting width: 144 mm (8 rail units)

Change-over time

for direction change: 1 sec

Switch-on time, blinds operation: 2 min

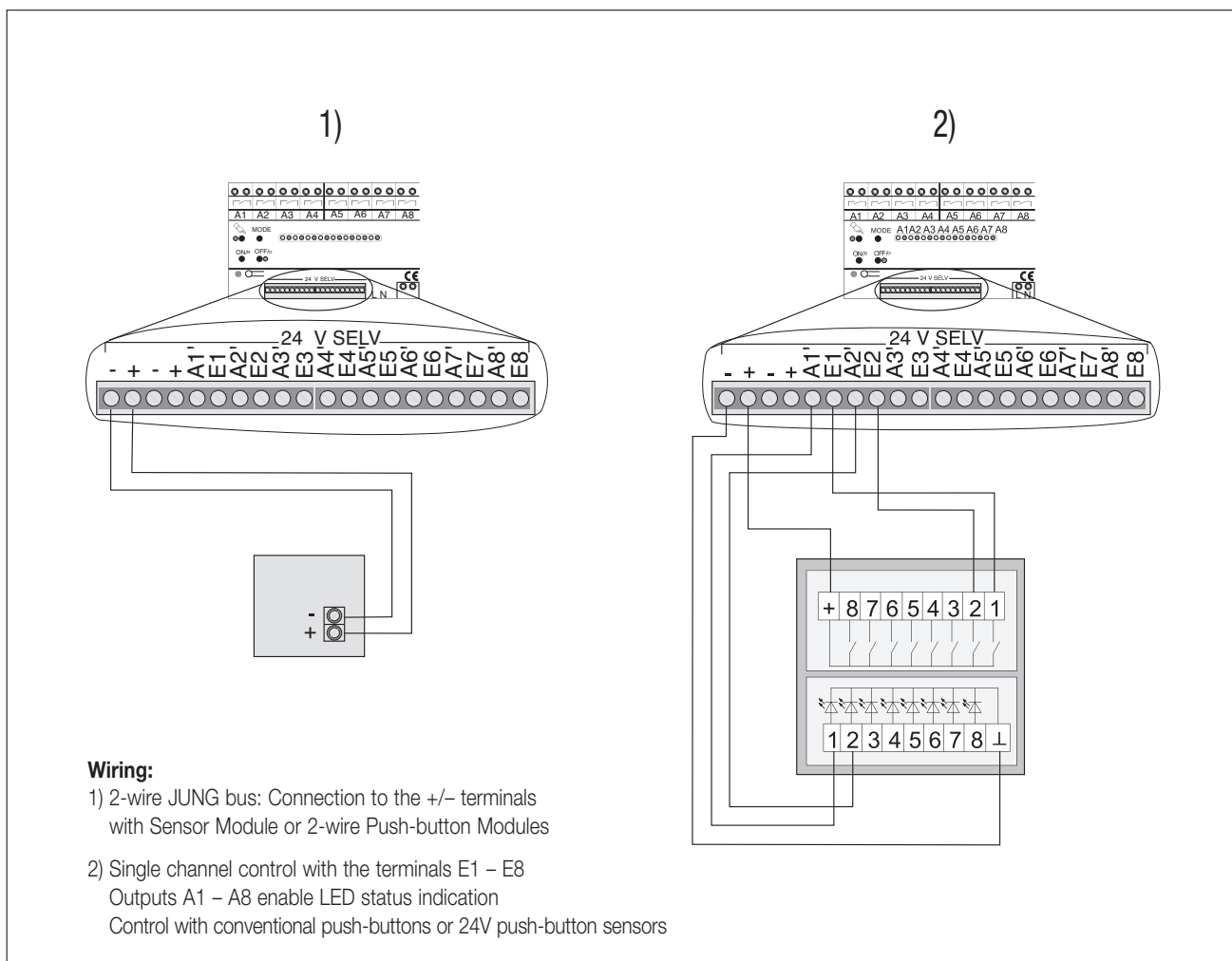
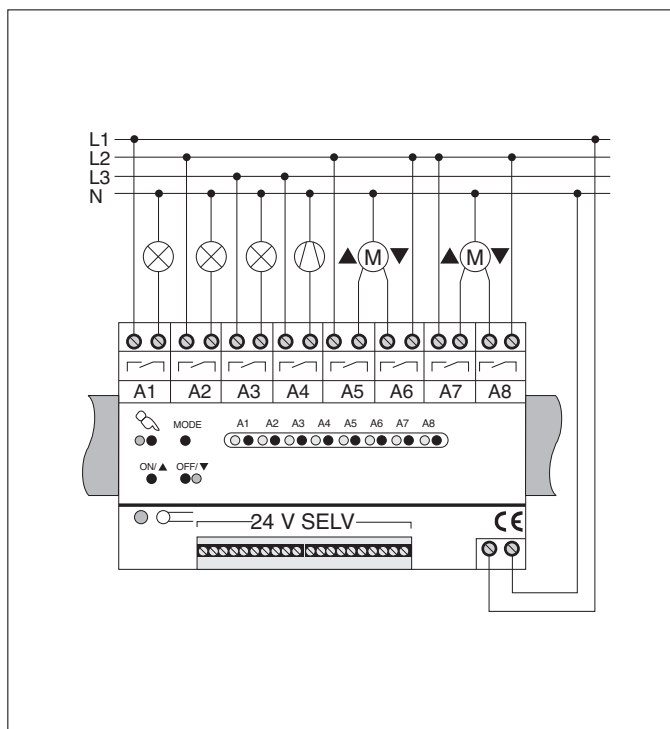

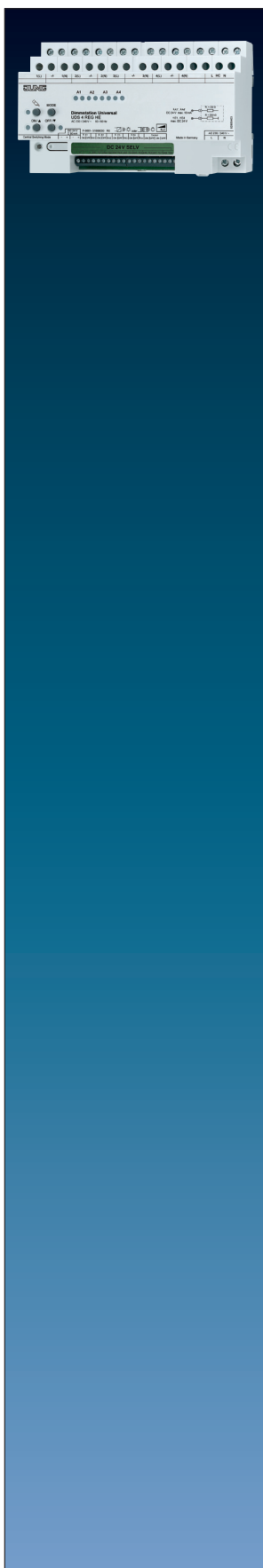

Ref.-no.

Universal Dimming Station 4-gang

Rail mounting device,
8 units

UDS 4 REGHE

Intended use

- Switching and dimming of incandescent lamps, 230 V halogen lamps, TRONIC and conventional transformers
- Mixed loads of the specified types (do not mix C and L loads)
- Operation by means of push-button sensors, sensor modules, push-button modules or unit installation buttons
- It is not possible to operate the device with universal amplifiers in conjunction with electronic transformers! Please use Tronic amplifiers for power extension when operating electronic transformers.

Product features

- Local control. The dimming station can be controlled using the keypad when the control sections are not connected.
- Activation of status LEDs on the control sections. The relay station has the activation outputs A1'...A4' for this purpose.
- Electronic short circuit protection with permanent cut-off after 7 seconds
- Electronic overtemperature protection
- Integrated memory function for each channel (storing of brightness value)
- Lamp-saving soft start
- Switching off with dim-down function
- Increasing the capacity by means of parallel wiring of outputs possible
- Connection of amplifier possible
- Special connection for hotel card switch
- Central switching function All On, All Off
- Parallel connection of two dimming stations (or dimming + relay station) possible

Function hotel card switch

A hotel card switch is connected to the dimming station. When plugging in the hotel card the light will be switched on with the stored brightness level. After removing the hotel card the light remains on and can be controlled for 1 more minute. After the time has elapsed the light starts dimming down to minimum brightness and switches off within 3 minutes. The dimming station can be controlled again after plugging in the hotel card.

Technical Data

Rated voltage: AC 230/240 V ~, 50/60 Hz
 Power loss: max. 20 W
 Stand-by power: max. 2 W

Terminals -, +

Control voltage: DC 24 V SELV
 Max. admissible current: Σ 80 mA
 Length of control cable: max. 100 m

Number of control units
 Sensor module (ref.-no. SM 1608): max. 4 (also when relay/dimming stations are connected in parallel)
 Push-button module (ref.-no. 4008 TSM): max. 4 (also when relay/dimming stations are connected in parallel)
 Push-button sensors 24 V AC/DC (make): depending on push-button sensor, consider current consumption

Switching inputs E1ON/OFF ... E4ON/OFF

Control voltage: DC 24 V SELV
 Resistance Ri: 200 k Ω

Activation outputs A1' ... A4'

Control voltage: DC 24 V SELV
 Max. admissible current: 10 mA
 Resistance Ra: 330 Ω

Wiring

Mains / load outputs / key card switch
 single wire: 1.5 ... 4 mm²
 stranded without ferrule: 0.75 ... 4 mm²
 stranded with ferrule: 0.5 ... 2.5 mm²

Switching inputs / activation outputs / control units:
 single wire: 1.5 mm²
 stranded without ferrule: 1 mm²
 stranded with ferrule: 0.75 mm²

Load outputs A1 ... A4

Contact type: ε
 Length of output cable, per channel: max. 100 m
 Connected load per channel
 Incandescent lamps: 20 ... 150 W
 HV halogen lamps: 20 ... 150 W
 TRONIC transformers: 20 ... 150 W
 conventional transformers: 20 ... 150 VA
 ohmic-capacitive: 20 ... 150 W
 ohmic-inductive: 20 ... 150 VA
 capacitive-inductive: not permitted
 Reduction of load for every 5 °C exceeding 45 °C: -15 %
 Mounting width: 144 mm (8 rail units)

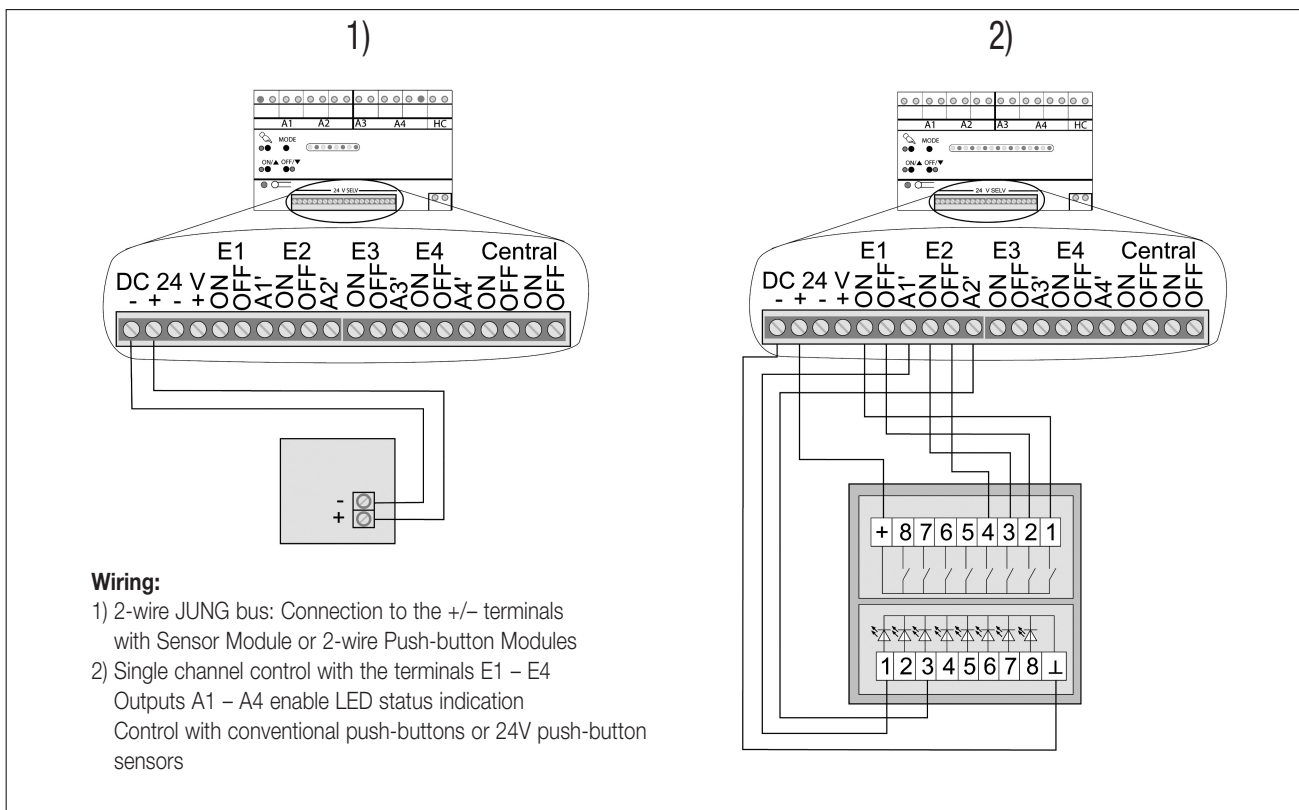
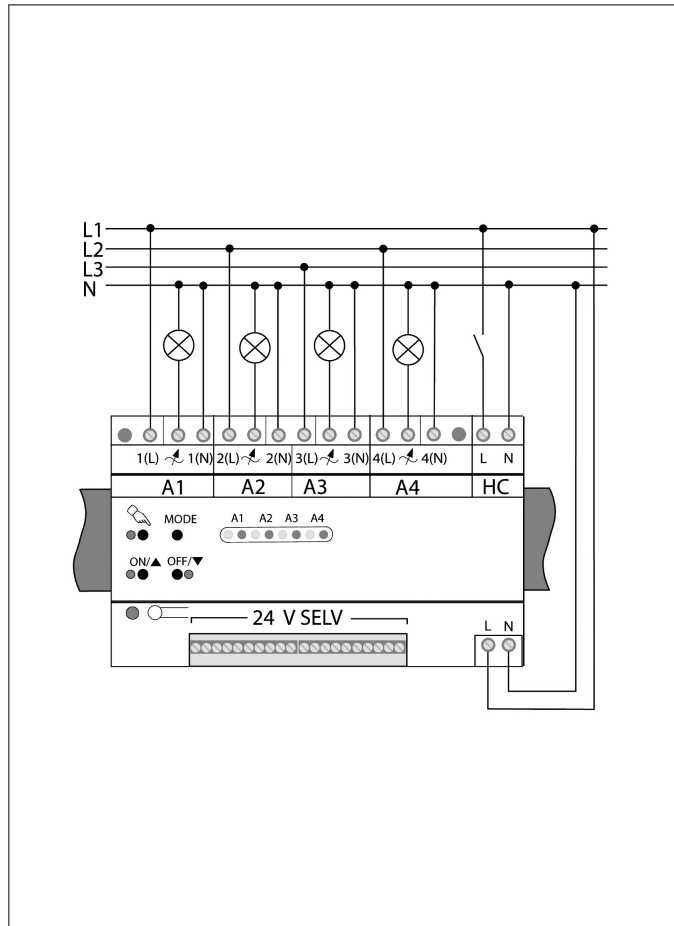

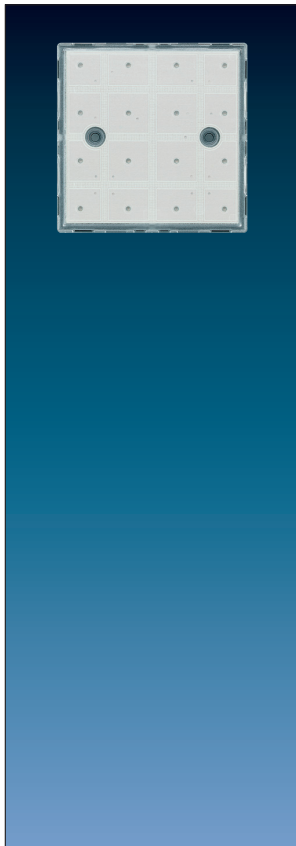

Ref.-no.

SM 1608

Sensor module

for the connection to the universal relay station and dimming station
only for the design frames of the LS ranges

Features

- Channel control of relay and dimming station: Switching, dimming, push-button control, blind control
- 16 channels can be controlled when connected to 2 parallel-wired relay stations
- Up to 4 light scenes can be stored in the sensor module
- Additional central function: all the switching channels of the relay station are controlled centrally
- 16 sensor pads with blue LEDs which can be grouped as required
- Programming without additional tools
- Free assignment of the groups to the channels
- LEDs can be used for status feedback and as orientation lights
- Status feedback of the switching states on all connected sensor modules
- Brightness of the status LEDs can be set in three levels (OFF, 50 %, 100 %)
- Up to 4 sensor modules can be connected to single or parallel connected relay/dimming stations
- Cloning of sensor modules: transfer of the push-button assignment of a sensor module to further sensor modules (used e.g. in two-way circuits or intermediate switch circuits)
- Settings on the device are retained even after mains voltage failure
- Simple installation via 2-wire cable
- Labelling possible (text, graphics, photo)

Technical Data

Power supply:	via relay or dimming station universal DC 24 SELV
Current consumption:	max. 20 mA (all LEDs on)
Wiring:	bus connection block
Ambient temperature:	+5 °C ... +25 °C
Storing temperature:	-25 °C ...+75 °C

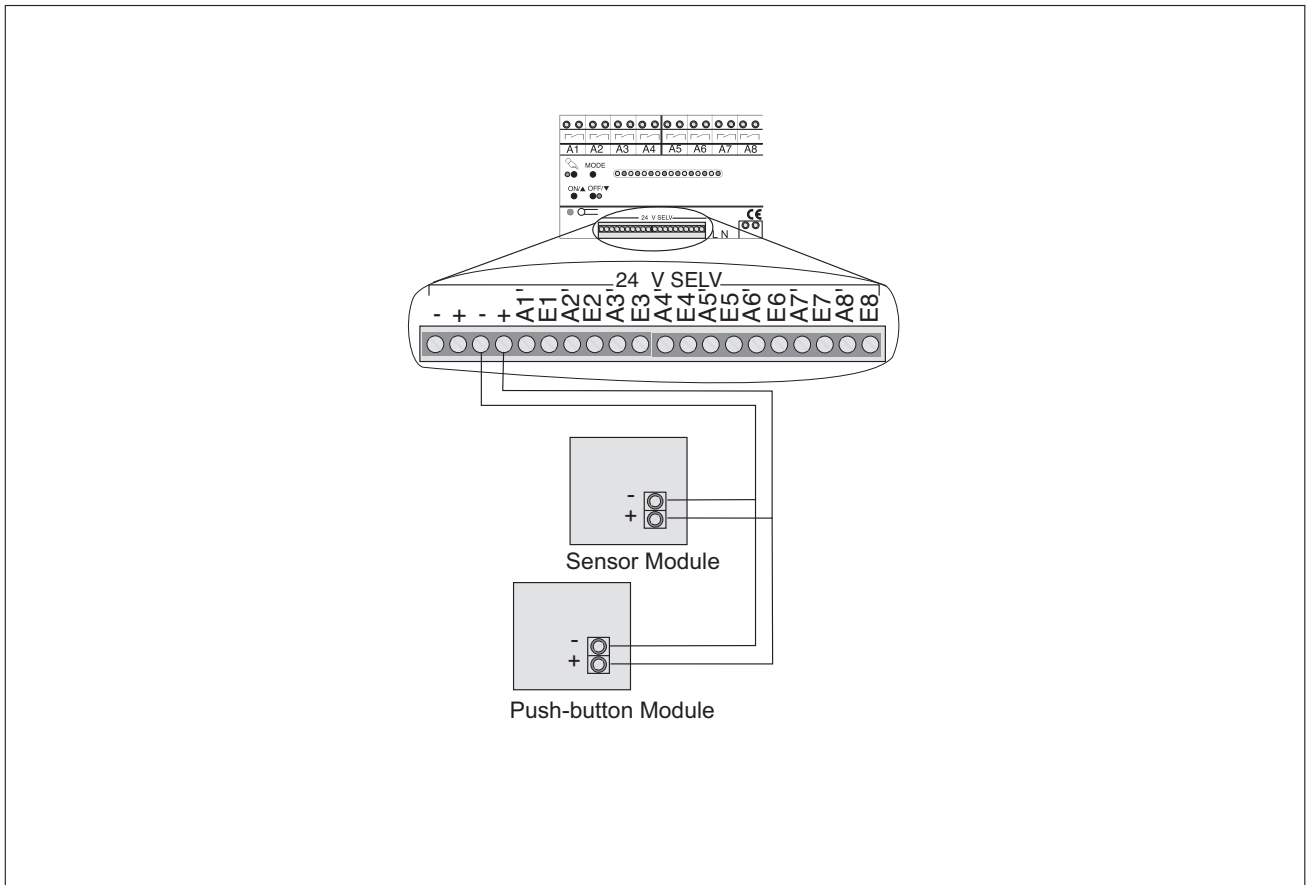

Ref.-no.

Push-button module

4008 TSM

for the connection to the universal relay station and dimming station
 Adapter frames ref.-no. LS 4 AR for LS design ranges is premounted

Features

- Channel control of relay and dimming station: Switching, dimming, push-button control, blind control
- 16 channels of 2 parallel-wired relay/dimming stations can be controlled in combination with push-button extension module ref.-no.: 4094 TSEM
- Up to 4 light scenes can be stored in the push-button module
- Additional central function: all assigned channels of the relay station are controlled centrally
- Push-buttons can be assigned according to cover kit
- Programming without additional tools
- Free assignment of the groups to the channels
- 8 red status LED
- 1 blue operation LED
- Status feedback of the switching states to connected push-button modules and sensor modules
- Up to 4 push-button modules with max. 4 extension modules can be connected to a relay station
- Cloning of modules: transfer the assignment of one module to further modules
- (Cloning of push-button modules with extension module is possible)
- Simple installation via 2-wire cable

Technical Data

Power supply:	via relay station universal DC 24 V SELV
Current consumption:	max. 20 mA (all LEDs on)
Wiring:	bus connection block
Ambient temperature:	+5 ... +25 °C
Storing temperature:	-25 ... +75 °C

Universal push-button extension module

4094 TSEM

for the extension of up to 8 additional push-buttons for the push-button module ref.-no. 4008 TSM
 preferred installation: vertical
 8 red LED: status indication

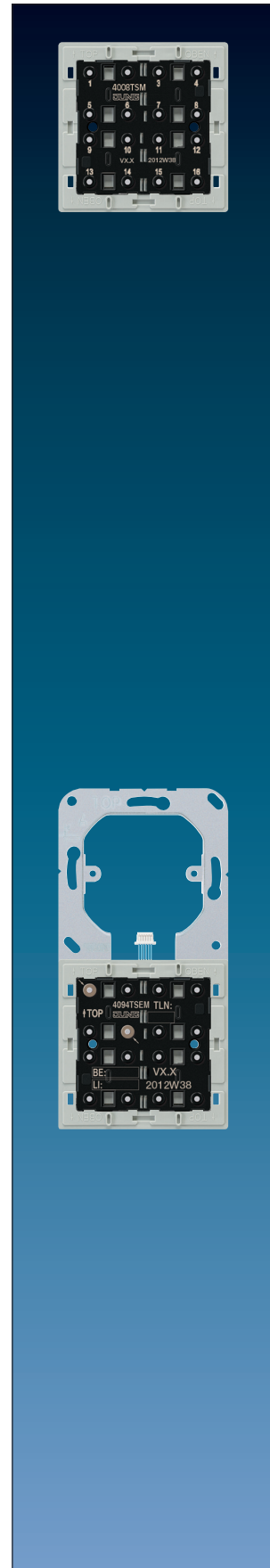
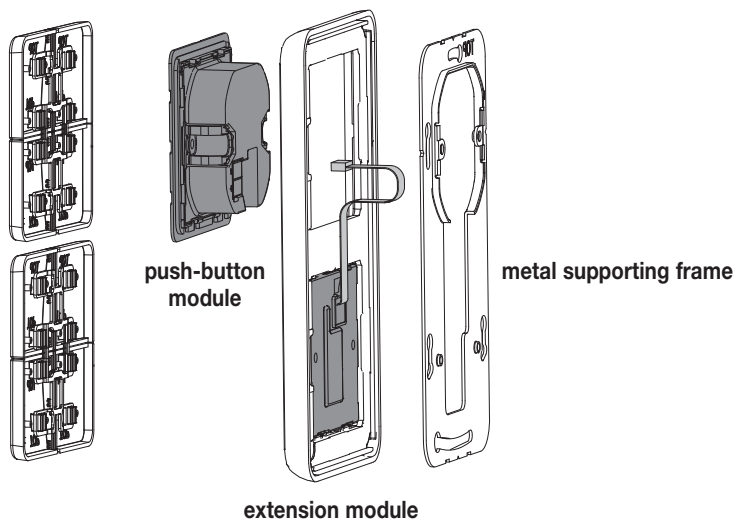

Cover for modules

A ranges



Ref.-no.

1-gang

to clip on modules: 4008 TSM, 4094 TSEM and 4212 TSM

ivory	L	A 401 TSA
white	L	A 401 TSA WW
aluminium	L	A 401 TSA AL
black	P L	A 401 TSA SW
chamapgne	P	A 401 TSA CH
mocha		A 401 TSA MO

1-gang with symbols

ivory	L	A 401 TSAP
white	L	A 401 TSAP WW
aluminium	L	A 401 TSAP AL
black	P L	A 401 TSAP SW
chamapgne	P	A 401 TSAP CH
mocha		A 401 TSAP MO

2-gang

to clip on modules: 4008 TSM, 4094 TSEM and 4224 TSM

ivory	L	A 402 TSA
white	L	A 402 TSA WW
aluminium	L	A 402 TSA AL
black	P L	A 402 TSA SW
chamapgne	P	A 402 TSA CH
mocha		A 402 TSA MO

3-gang

to clip on modules: 4008 TSM, 4094 TSEM and 4236 TSM

ivory	L	A 403 TSA
white	L	A 403 TSA WW
aluminium	L	A 403 TSA AL
black	P L	A 403 TSA SW
chamapgne	P	A 403 TSA CH
mocha		A 403 TSA MO

4-gang

to clip on modules: 4008 TSM, 4094 TSEM and 4248 TSM

ivory	L	A 404 TSA
white	L	A 404 TSA WW
aluminium	L	A 404 TSA AL
black	P L	A 404 TSA SW
chamapgne	P	A 404 TSA CH
mocha		A 404 TSA MO

Cover for modules

A ranges

Ref.-no.

Covers for 2-gang and 3-gang

2-gang: to exchange both covers
3-gang: to exchange right cover

ivory	L	A 402 TSAN
white	L	A 402 TSAN WW
aluminium	L	A 402 TSAN AL
black	P L	A 402 TSAN SW
chamapgne	P	A 402 TSAN CH
mocha		A 402 TSAN MO

Covers with symbols for 2-gang and 3-gang

ivory	L	A 402 TSAP
white	L	A 402 TSAP WW
aluminium	L	A 402 TSAP AL
black	P L	A 402 TSAP SW
chamapgne	P	A 402 TSAP CH
mocha		A 402 TSAP MO

Covers for 3-gang and 4-gang

3-gang: to exchange upper left cover
4-gang: to exchange upper left or lower right cover

ivory	L	A 404 TSAN 14
white	L	A 404 TSAN WW 14
aluminium	L	A 404 TSAN AL 14
black	P L	A 404 TSAN SW 14
chamapgne	P	A 404 TSAN CH 14
mocha		A 404 TSAN MO 14

Covers with symbols for 3-gang and 4-gang

ivory	L	A 404 TSAP 14
white	L	A 404 TSAP WW 14
aluminium	L	A 404 TSAP AL 14
black	P L	A 404 TSAP SW 14
chamapgne	P	A 404 TSAP CH 14
mocha		A 404 TSAP MO 14

Covers for 3-gang and 4-gang

3-gang: to exchange lower left cover
4-gang: to exchange lower left or upper right cover

ivory	L	A 404 TSAN 23
white	L	A 404 TSAN WW 23
aluminium	L	A 404 TSAN AL 23
black	P L	A 404 TSAN SW 23
chamapgne	P	A 404 TSAN CH 23
mocha		A 404 TSAN MO 23

Covers with symbols for 3-gang and 4-gang

ivory	L	A 404 TSAP 23
white	L	A 404 TSAP WW 23
aluminium	L	A 404 TSAP AL 23
black	P L	A 404 TSAP SW 23
chamapgne	P	A 404 TSAP CH 23
mocha		A 404 TSAP MO 23

Important: There are different **covers with symbol** for each position on the push-button module. E.g. for the 4-gang module 2 different types of covers have to be selected. One for the upper left and lower right position, one for the upper right and the lower left position.

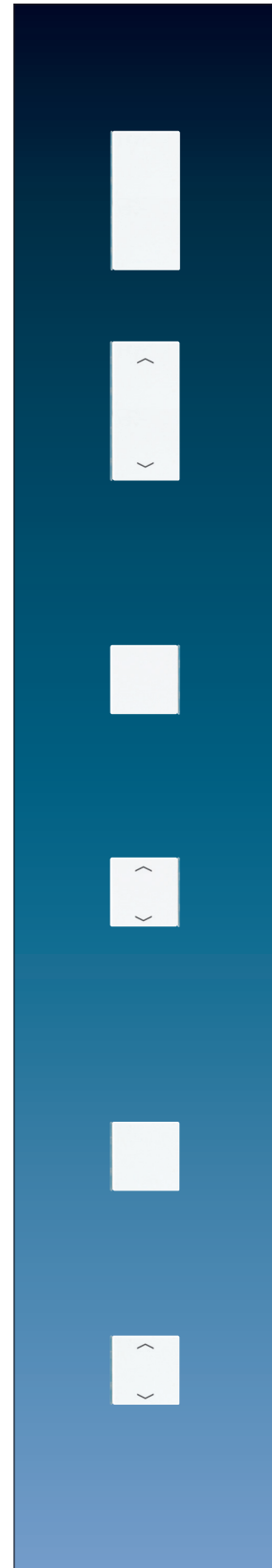

Cover for modules

CD ranges

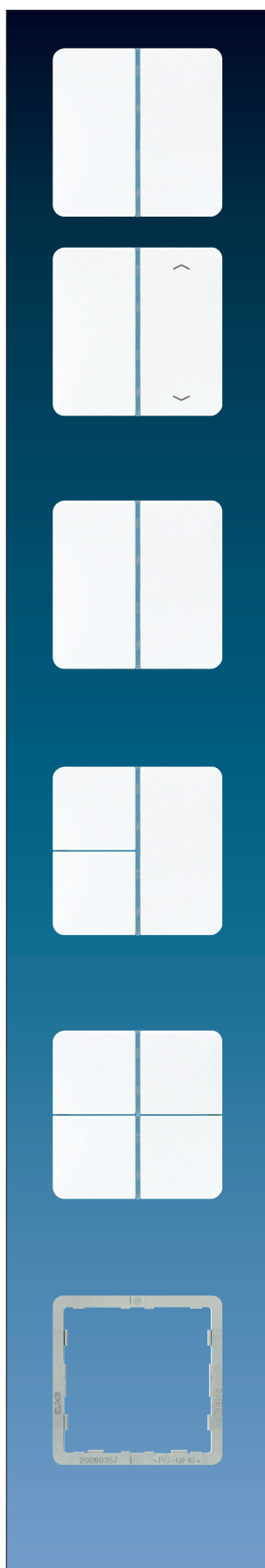

Ref.-no.

1-gang

to clip on modules: 4008 TSM, 4094 TSEM and 4212 TSM

ivory	CD 401 TSA
white	CD 401 TSA WW
grey	CD 401 TSA GR
light grey	CD 401 TSA LG
black	CD 401 TSA SW

1-gang with symbols

ivory	CD 401 TSAP
white	CD 401 TSAP WW
grey	CD 401 TSAP GR
light grey	CD 401 TSAP LG
black	CD 401 TSAP SW

2-gang

to clip on modules: 4008 TSM, 4094 TSEM and 4224 TSM

ivory	CD 402 TSA
white	CD 402 TSA WW
grey	CD 402 TSA GR
light grey	CD 402 TSA LG
black	CD 402 TSA SW

3-gang

to clip on modules: 4008 TSM, 4094 TSEM and 4236 TSM

ivory	CD 403 TSA
white	CD 403 TSA WW
grey	CD 403 TSA GR
light grey	CD 403 TSA LG
black	CD 403 TSA SW

4-gang

to clip on modules: 4008 TSM, 4094 TSEM and 4248 TSM

ivory	CD 404 TSA
white	CD 404 TSA WW
grey	CD 404 TSA GR
light grey	CD 404 TSA LG
black	CD 404 TSA SW

Adapter frame































The adapter frame is required to clip the CD cover kit onto the push-button module.

CD 4 AR

(spare part)

Cover for modules

CD ranges

	Ref.-no.
Covers for 2-gang and 3-gang	
2-gang: to exchange both covers	
3-gang: to exchange right cover	
ivory	 CD 402 TSAN
white	 CD 402 TSAN WW
grey	 CD 402 TSAN GR
light grey	 CD 402 TSAN LG
black	 CD 402 TSAN SW
Covers with symbols for 2-gang and 3-gang	
ivory	 CD 402 TSAP
white	 CD 402 TSAP WW
grey	 CD 402 TSAP GR
light grey	 CD 402 TSAP LG
black	 CD 402 TSAP SW
Covers for 3-gang and 4-gang	
3-gang: to exchange upper left cover	
4-gang: to exchange upper left or lower right cover	
ivory	 CD 404 TSAN 14
white	 CD 404 TSAN WW 14
grey	 CD 404 TSAN GR 14
light grey	 CD 404 TSAN LG 14
black	 CD 404 TSAN SW 14
Covers with symbols for 3-gang and 4-gang	
ivory	 CD 404 TSAP 14
white	 CD 404 TSAP WW 14
grey	 CD 404 TSAP GR 14
light grey	 CD 404 TSAP LG 14
black	 CD 404 TSAP SW 14
Covers for 3-gang and 4-gang	
3-gang: to exchange lower left cover	
4-gang: to exchange lower left or upper right cover	
ivory	 CD 404 TSAN 23
white	 CD 404 TSAN WW 23
grey	 CD 404 TSAN GR 23
light grey	 CD 404 TSAN LG 23
black	 CD 404 TSAN SW 23
Covers with symbols for 3-gang and 4-gang	
ivory	 CD 404 TSAP 23
white	 CD 404 TSAP WW 23
grey	 CD 404 TSAP GR 23
light grey	 CD 404 TSAP LG 23
black	 CD 404 TSAP SW 23

Important: There are different **covers with symbol** for each position on the push-button module. E.g. for the 4-gang module 2 different types of covers have to be selected. One for the upper left and lower right position, one for the upper right and the lower left position.



Cover for modules

LS 990



Ref.-no.

1-gang

to clip on modules: 4008 TSM, 4094 TSEM and 4212 TSM

ivory	LS 401 TSA
white	LS 401 TSA WW
light grey	LS 401 TSA LG
black	LS 401 TSA SW

1-gang with symbols

ivory	LS 401 TSAP
white	LS 401 TSAP WW
light grey	LS 401 TSAP LG
black	LS 401 TSAP SW

2-gang

to clip on modules: 4008 TSM, 4094 TSEM and 4224 TSM

ivory	LS 402 TSA
white	LS 402 TSA WW
light grey	LS 402 TSA LG
black	LS 402 TSA SW

3-gang

to clip on modules: 4008 TSM, 4094 TSEM and 4236 TSM

ivory	LS 403 TSA
white	LS 403 TSA WW
light grey	LS 403 TSA LG
black	LS 403 TSA SW

4-gang

to clip on modules: 4008 TSM, 4094 TSEM and 4248 TSM

























ivory	LS 404 TSA
white	LS 404 TSA WW
light grey	LS 404 TSA LG
black	LS 404 TSA SW

Adapter frame

The adapter frame is required to clip the LS cover kit onto the push-button module.

LS 4 AR

(spare part)

	Ref.-no.
Covers for 2-gang and 3-gang	
2-gang: to exchange both covers	
3-gang: to exchange right cover	
ivory	 LS 402 TSAN
white	 LS 402 TSAN WW
light grey	 LS 402 TSAN LG
black	 LS 402 TSAN SW
Covers with symbols for 2-gang and 3-gang	
ivory	 LS 402 TSAP
white	 LS 402 TSAP WW
light grey	 LS 402 TSAP LG
black	 LS 402 TSAP SW
Covers for 3-gang and 4-gang	
3-gang: to exchange upper left cover	
4-gang: to exchange upper left or lower right cover	
ivory	 LS 404 TSAN 14
white	 LS 404 TSAN WW 14
light grey	 LS 404 TSAN LG 14
black	 LS 404 TSAN SW 14
Covers with symbols for 3-gang and 4-gang	
ivory	 LS 404 TSAP 14
white	 LS 404 TSAP WW 14
light grey	 LS 404 TSAP LG 14
black	 LS 404 TSAP SW 14
Covers for 3-gang and 4-gang	
3-gang: to exchange lower left cover	
4-gang: to exchange lower left or upper right cover	
ivory	 LS 404 TSAN 23
white	 LS 404 TSAN WW 23
light grey	 LS 404 TSAN LG 23
black	 LS 404 TSAN SW 23
Covers with symbols for 3-gang and 4-gang	
ivory	 LS 404 TSAP 23
white	 LS 404 TSAP WW 23
light grey	 LS 404 TSAP LG 23
black	 LS 404 TSAP SW 23

Important: There are different **covers with symbol** for each position on the push-button module. E.g. for the 4-gang module 2 different types of covers have to be selected. One for the upper left and lower right position, one for the upper right and the lower left position.

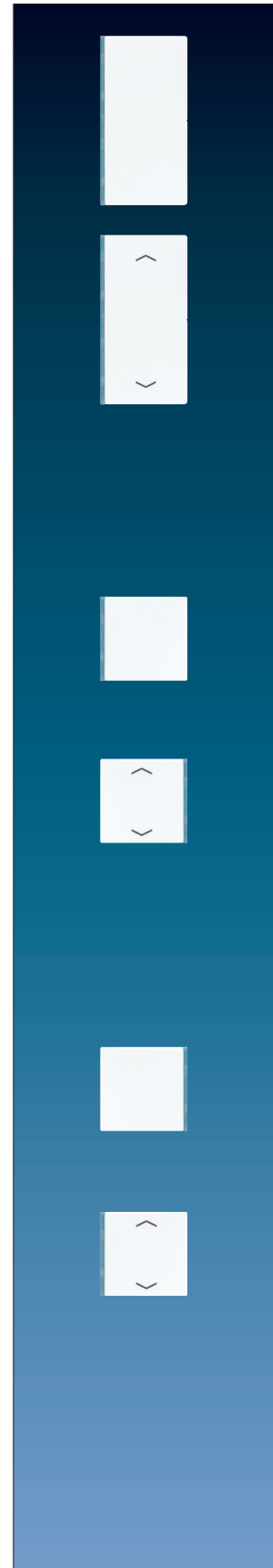

Cover for modules

LS Metal finish

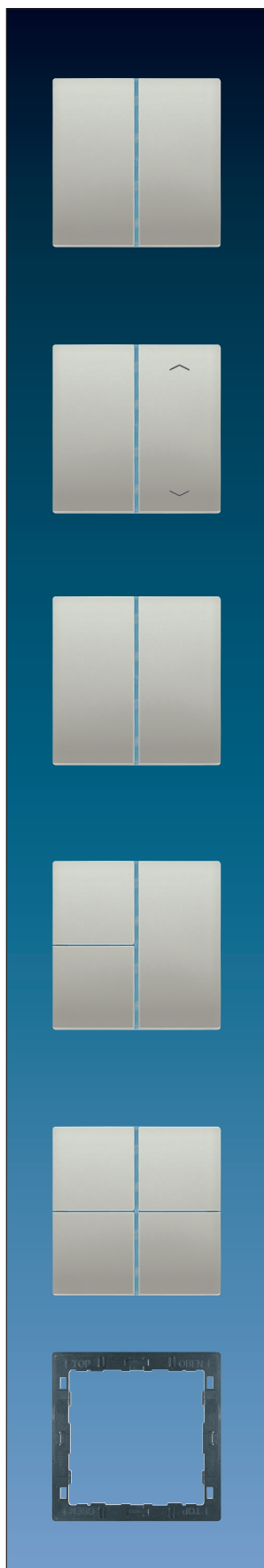

Ref.-no.

1-gang

to clip on modules: 4008 TSM, 4094 TSEM and 4212 TSM

Metal versions

aluminium	P	L	AL 2401 TSA
stainless steel		L	ES 2401 TSA
anthracite (aluminium lacquered)		L	AL 2401 TSA AN
classic brass	P		ME 2401 TSA C
antique brass			ME 2401 TSA AT
dark brass			ME 2401 TSA D

1-gang with symbols

aluminium	P	L	AL 2401 TSAP
stainless steel		L	ES 2401 TSAP
anthracite (aluminium lacquered)		L	AL 2401 TSAP AN
classic brass	P		ME 2401 TSAP C
antique brass			ME 2401 TSAP AT
dark brass			ME 2401 TSAP D

2-gang

to clip on modules: 4008 TSM, 4094 TSEM and 4224 TSM

aluminium	P	L	AL 2402 TSA
stainless steel		L	ES 2402 TSA
anthracite (aluminium lacquered)		L	AL 2402 TSA AN
classic brass	P		ME 2402 TSA C
antique brass			ME 2402 TSA AT
dark brass			ME 2402 TSA D

3-gang

to clip on modules: 4008 TSM, 4094 TSEM and 4236 TSM

aluminium	P	L	AL 2403 TSA
stainless steel		L	ES 2403 TSA
anthracite (aluminium lacquered)		L	AL 2403 TSA AN
classic brass	P		ME 2403 TSA C
antique brass			ME 2403 TSA AT
dark brass			ME 2403 TSA D

4-gang

to clip on modules: 4008 TSM, 4094 TSEM and 4248 TSM

aluminium	P	L	AL 2404 TSA
stainless steel		L	ES 2404 TSA
anthracite (aluminium lacquered)		L	AL 2404 TSA AN
classic brass	P		ME 2404 TSA C
antique brass			ME 2404 TSA AT
dark brass			ME 2404 TSA D

Adapter frame

The adapter frame is required to clip the LS cover kit onto the push-button module.

LS 4 AR

(spare part)

Cover for modules

LS Metal finish

Ref.-no.

Covers for 2-gang and 3-gang

2-gang: to exchange both covers
3-gang: to exchange right cover

aluminium	P L	AL 2402 TSAN
stainless steel	L	ES 2402 TSAN
anthracite (aluminium lacquered)	L	AL 2402 TSAN AN
classic brass	P	ME 2402 TSAN C
antique brass		ME 2402 TSAN AT
dark brass		ME 2402 TSAN D

Covers with symbols for 2-gang and 3-gang

aluminium	P L	AL 2402 TSAP
stainless steel	L	ES 2402 TSAP
anthracite (aluminium lacquered)	L	AL 2402 TSAP AN
classic brass	P	ME 2402 TSAP C
antique brass		ME 2402 TSAP AT
dark brass		ME 2402 TSAP D

Covers for 3-gang and 4-gang

3-gang: to exchange upper left cover
4-gang: to exchange upper left or lower right cover

aluminium	P L	AL 2404 TSAN 14
stainless steel	L	ES 2404 TSAN 14
anthracite (aluminium lacquered)	L	AL 2404 TSAN AN 14
classic brass	P	ME 2404 TSAN C 14
antique brass		ME 2404 TSAN AT 14
dark brass		ME 2404 TSAN D 14

Covers with symbols for 3-gang and 4-gang

aluminium	P L	AL 2404 TSAP 14
stainless steel	L	ES 2404 TSAP 14
anthracite (aluminium lacquered)	L	AL 2404 TSAP AN 14
classic brass	P	ME 2404 TSAP C 14
antique brass		ME 2404 TSAP AT 14
dark brass		ME 2404 TSAP D 14

Covers for 3-gang and 4-gang

3-gang: to exchange lower left cover
4-gang: to exchange lower left or upper right cover

aluminium	P L	AL 2404 TSAN 23
stainless steel	L	ES 2404 TSAN 23
anthracite (aluminium lacquered)	L	AL 2404 TSAN AN 23
classic brass	P	ME 2404 TSAN C 23
antique brass		ME 2404 TSAN AT 23
dark brass		ME 2404 TSAN D 23

Covers with symbols for 3-gang and 4-gang

aluminium	P L	AL 2404 TSAP 23
stainless steel	L	ES 2404 TSAP 23
anthracite (aluminium lacquered)	L	AL 2404 TSAP AN 23
classic brass	P	ME 2404 TSAP C 23
antique brass		ME 2404 TSAP AT 23
dark brass		ME 2404 TSAP D 23

Important: There are different **covers with symbol** for each position on the push-button module. E.g. for the 4-gang module 2 different types of covers have to be selected. One for the upper left and lower right position, one for the upper right and the lower left position.

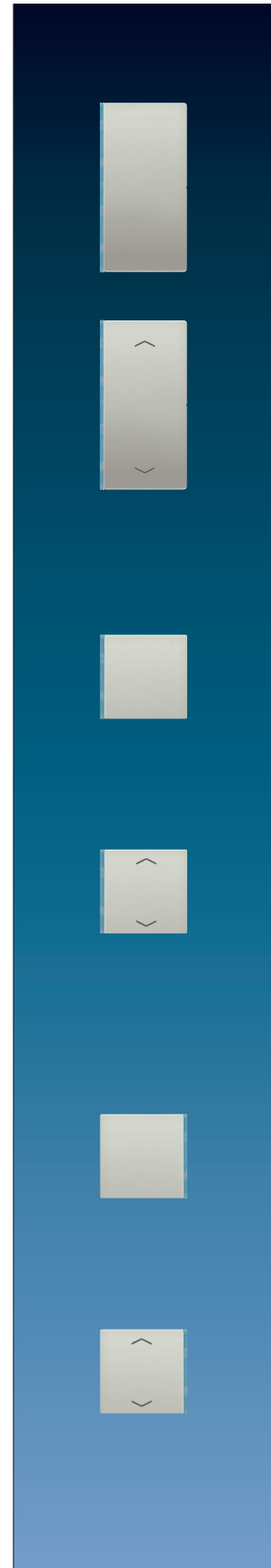

Conventional 24V push-button sensors

The conventional push-button sensors offer the possibility to combine JUNG design ranges with other control systems. Up to 8 make contacts are integrated in a push-button sensor which can be used for the control of PLC systems or other 24V systems. Additionally up to 8 LEDs indicate the respective switching status. In any case this push-button sensors can be used to control the relay station or the dimming station. Choose your favourite cover of the A-, CD and LS ranges which are available in various colours and metal finish variants. The large control buttons are available in same design ranges.



A creation



CD 500



LS 990

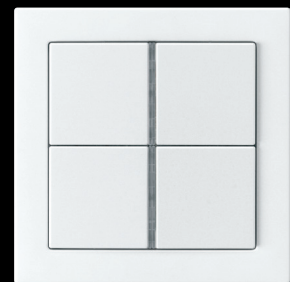

Flat Design

JUNG



Acreation



CD 500



LS 990

Push-button sensor 24 V

A / CD / LS ranges



Ref.-no.

Push-button sensor 24 V AC/DC, 20 mA

for AS 500, A 500, A plus and A creation

2-gang, 2-channel – 4 contacts

ivory	A 2224
white	A 2224 WW
aluminium	A 2224 AL
black	A 2224 SW

4-gang, 4-channel – 8 contacts

ivory	A 2248
white	A 2248 WW
aluminium	A 2248 AL
black	A 2248 SW

for the LS design ranges

2-gang, 2-channel – 4 contacts

ivory	LS 2224
white	LS 2224 WW
light grey	LS 2224 LG
black	LS 2224 SW

Metal versions

aluminium (lacquered)	AL 2224
stainless steel	ES 2224
anthracite (lacquered)	AL 2224 AN

4-gang, 4-channel – 8 contacts

ivory	LS 2248
white	LS 2248 WW
light grey	LS 2248 LG
black	LS 2248 SW

Metal versions

aluminium (lacquered)	AL 2248
stainless steel	ES 2248
anthracite (lacquered)	AL 2248 AN

for the CD design ranges

2-gang, 2-channel – 4 contacts

ivory	CD 2224
white	CD 2224 WW

4-gang, 4-channel – 8 contacts

ivory	CD 2248
white	CD 2248 WW

For individual inscription please visit our website www.jung-label.de

Push-button module 24 V

A / CD / LS ranges

Ref.-no.

Conventional push-button modules for the connection to the universal relay station, dimming station and other control systems with control voltage of max. 24 V AC/DC (SELV), 20 mA.

The module is connected by means of a connection block at the back.
To each push-button two red LEDs are assigned for status indication.

Push-button module 24 V AC/DC, 20 mA

1-gang	1-channel	2 contacts	4212 TSM
2-gang	2-channel	4 contacts	4224 TSM
3-gang	3-channel	6 contacts	4236 TSM
4-gang	4-channel	8 contacts	4248 TSM

Covers on page 18 – 25.

There are different **covers with symbol** for each position on the push-button module.
E.g. for the 4-gang module 2 different types of covers have to be selected. One for the upper left and lower right position, one for the upper right and the lower left position.

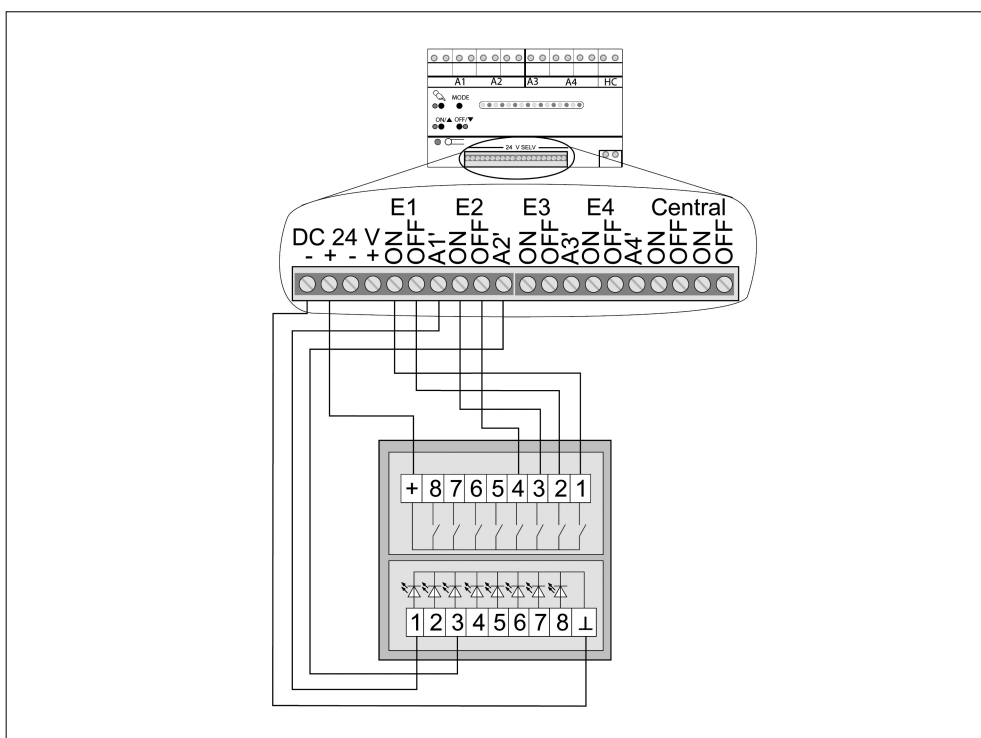

JUNG

P-GB-JBUS 0913



4 011377 078352

ALBRECHT JUNG GMBH & CO. KG
P.O. Box 1320
58569 Schalksmühle
Germany

Tel.: +49 2355 806-553
Fax: +49 2355 806-254
E-mail: mail.vka@jung.de
Internet: www.jung.de

For sales contacts in your country see:
www.jung-salescontact.com



Certified proof
of origine
„Made in Germany“
by TÜV NORD.