

JUNG



The intelligent system
for smart buildings





The trademark

The KNX is a building management and control system tailored to suit the electrical installations. Leading European companies in electrical installation engineering – including JUNG – founded an organisation with the aim to achieve a standardisation and widespread acceptance of the KNX in Europe and worldwide. KNX is a „Societe Coopérative“ under Belgian law with its headquarters in Brussels. The trademark KNX visually underlines the system compatibility of the products.

The purpose of the organisation is to promote building management systems in a standardised form on the European market, to achieve fast, widespread acceptance and develop the trademark to a seal of quality. Technical guidelines for the system and the products, together with quality regulations will be drawn up by the company accordingly. This will ensure that KNX bus equipment from various manufacturers within a system can communicate with each other.

The KNX system

The demands made on modern electrical installations in private homes and on business premises have changed considerably. More and more emphasis is being placed on safety, operational ease and flexible use. The limits for conventional installations with a confusing number of own functional networks for electrical power, heating, lighting and shutter control, burglar alarm system, smoke, gas and fire detectors, however, have long been reached.

Installation and power costs have increased. Subsequent upgrading, renovation and change of system operation is expensive and complicated. The KNX System offers a convincing perspective. The KNX System is an intelligent building management system for measuring, regulating, switching, controlling, signalling and monitoring. Installed additionally to the power supply network, information transmission via a bus line is suitable for all specific applications. This electronic control system does not require a central unit as it is located decentralised in every individual appliance. All consumers connected to this mutual bus line, such as switches, sensors, actuators, displays, control units etc. can exchange information via this communication line which can also be compiled logically for evaluation.

The bus can be installed in line, star or tree structure. All devices can be selected freely and are interactive. The information transmission can contain analogue functions (temperature, time, quantity etc.) and digital functions (yes/no, on/off, light/dark, warm/cold, long/short, more/less). Dimmer functions are of course also possible.

JUNG



Controlling

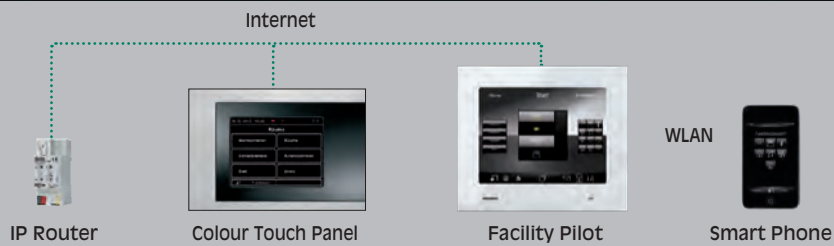

Sensors

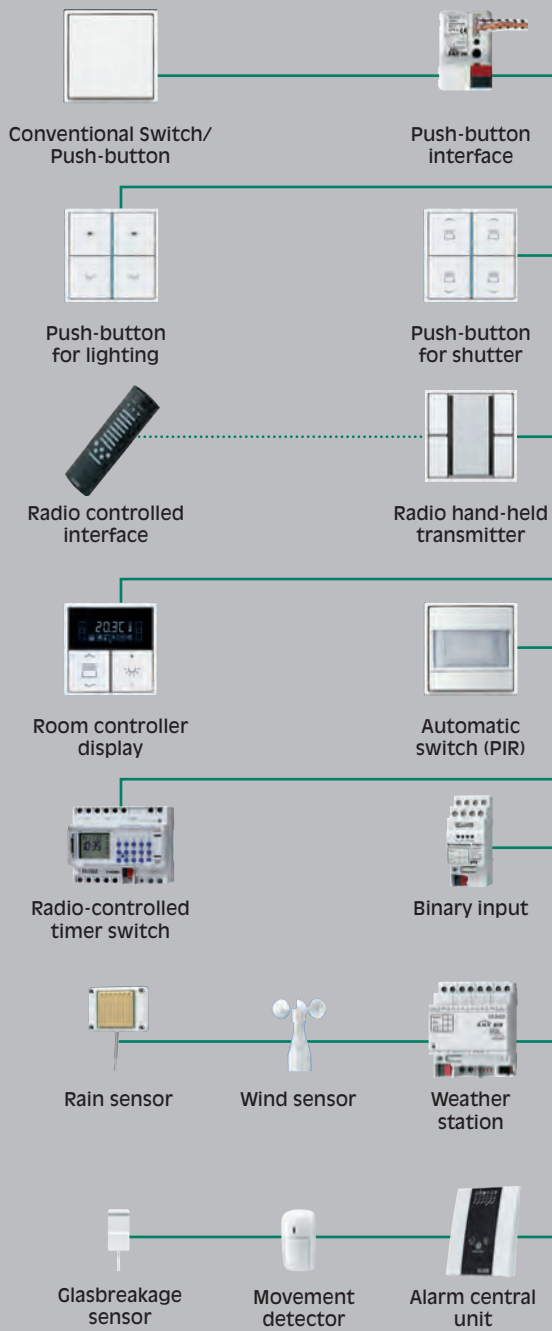

Actuators

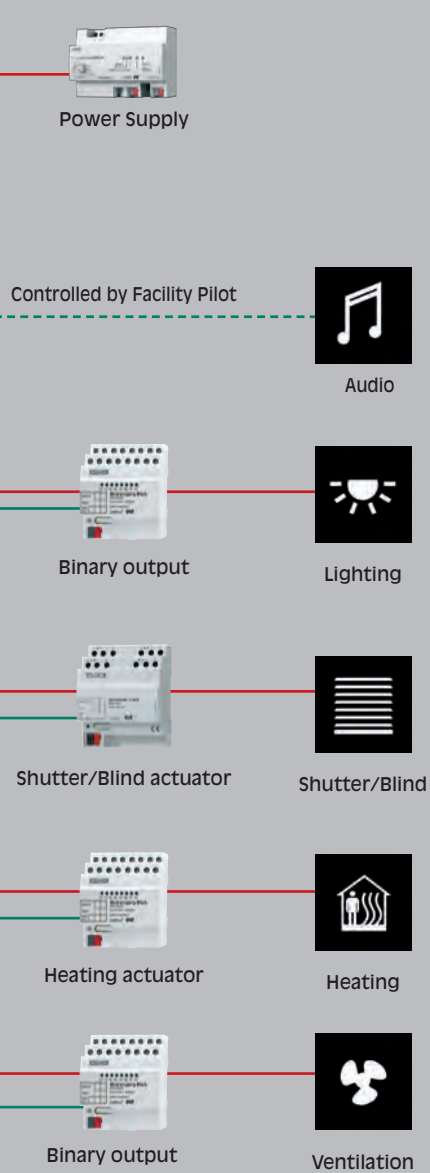

Additional KNX Arealines

The JUNG KNX System

With KNX, all devices are linked to the system and can communicate with each other. The devices send telegrams along the bus line. These are coupled with an address number and can only be processed by the specified recipients with this address number. More than one recipient can be addressed simultaneously with this address so that it is possible to form groups. The recipient(s) receive(s) the telegram and decode(s) the message which in the end contains a command – e.g. to switch on/off or dim. Once the command has been carried out, a variation of this can be sent back to the sensor by actuator as confirmation that the command has been carried out. The complete KNX system is split up into lines. A maximum of 64 devices can be connected to each line. Up to 12 lines are connected to the main line by line couplers. The maximum length per line is 1000 m. The lines can be installed in line, star or tree form. The bus management is designed on a multimaster principle, i.e. a central unit is not necessary. The decentralized access system CSMA/CA (carrier sense multiple access/collision avoidance) ensures fault-free operation of the bus system.

Important signals are assigned greater priority to ensure faster, preferential processing of the telegrams. Priorities, devices address, functions etc. are drawn up on a PC using planning software. The program is loaded into the system locally by personal computer. The use of an intelligent building installation system is recommended particularly in those areas where all demands on an optimised installation have to be fulfilled with a maximum degree of flexibility and comfort and a minimum of expenditure.

Heating, ventilation and air-conditioning systems, detection and alarm systems, light and blind/shutter control and load management can be combined and integrated. The same also applies for the „normal“ installations which, with their multifunctional structure, can be designed with much greater flexibility and ease.

Recommendation: the prophylactic installation of a bus line. The decisive advantage of using an KNX System becomes very apparent at the latest when additional installations are required. Practically all required additional functions can be achieved with the lowest possible wiring and a minimum of line materials. The use of higher ranking bus systems (e.g. backbone bus) makes it possible to equip large industrial and administrative buildings with the JUNG KNX System as well.

The most important components and terminology



A power supply generates the required operating voltage for the connected KNX system equipment via the bus line.



Sensors provide information such as switch commands or physical measured quantities in telegram form via the bus line to the receiver devices (actuators).



Actuators receive telegrams sent by the sensors and convert the in-coming commands into action (e.g. switching or dimming). The actuator also sends status information back onto the bus.



Equipment units which combine bus lines with each other and forward telegrams to other bus lines or limit to specific lines.



Blind/shutter control

The automatic lowering of blinds/shutters according to room temperature avoids the room being heated up necessarily. The control can be central and decentral. Blinds/shutters mounted outside, are protected against damage from high winds by wind sensors which, coupled with the blind/shutter control, prevent or initiate lowering or raising.

Lighting control units can be controlled centrally and decentrally. The illuminance can be reduced by switching off or dimming at programmed times (breaks, weekends, end of working day, company holidays etc.) or according to the room or outside brightness. This saves energy and reduces operating costs as well.

New requirements can be met quickly and safely by reparametering if room usage has been changed. Of course, comfortable light scene controls as well as a fully automated partition wall lighting control can be realised.

Heating, ventilation and air-conditioning systems

The reduction of the temperature in rooms not in use (meeting/conference rooms) is controlled by motion detectors. Time-dependent control of the room temperature also saves energy (e.g. at weekends and public holidays). A coupling with the blind/shutter control is recommended anywhere where there is direct sunlight as this prevents the room from heating up extremely resulting in additional demands on the air-conditioning system. Displays allow constant control of current temperatures.





Monitoring and alarm installations

Using sensors (door and window contacts), monitors or displays indicate which building openings are open and which are closed. Locking can be initiated electromechanically. Faults in the parts of the building or system are also displayed and documented by printer. This ensures that the complete building's installations are monitored.

Entertainment

There is an increasing desire to combine home and building automation with streaming of digital music. This integration is also known as audio multi-room multi-source application. For instance lighting and music control can be integrated in scenes, which can be selected at the push of a button from anywhere in the building. Audio streams are transmitted over Ethernet or wireless (IEEE 802.11) networks from a server with the open-source software to music players, and in turn controlled by the visualisation package Facility-Pilot. Supported audio streams are for instance Internet Radio, MP3, WAV and Ogg Vorbis.

Interfaces enable the coupling of personal computers (PC's) or neighbouring bus systems to the KNX bus systems. PC's for programming or service purposes and printers for documentation can be connected using RS 232 (V24) interfaces.





JUNG App „Smart Remote“

KNX Building Functions Remote Controlled

The JUNG App Smart Remote enables a comfortable and remote control of the entire KNX installation – i. e. lighting, blind/shutter, temperature and even multi media system control. Simply download the JUNG App Smart Remote in the iTunes Store and convert your iPhone, iPod Touch or iPad into your universal remote control.

With the “Welcome function” you are given a welcome home: the blinds go up, the lights are switched on, and the rooms are given your individual preferred temperature.

Control the appropriate lighting scenario with an iPhone? With “Smart Remote”, no problem! Easily control the lighting in the room as well by touching the touch screen.



JUNG

Thanks to the clear, easy-to-understand layout of the JUNG graphical user interfaces (GUI), you can control all room functions completely intuitively with a touch screen – whether it is the appropriate lighting scenario, shade protection, music in every room or your door communication system. This naturally applies just as much to the KNX panels with the Facility Pilot software as it does to the iPhone, iPod touch or iPad with “Smart Remote”.



Contents

	Device	Ref.-No.	Page	
Introduction	Features of the KNX system			
	Terminology			
	Applications			
Sensors Push-Buttons	Push-button x-gang – standard, A/AS-design	A 207x NABS..	12	
	Push-button x-gang – standard, CD 500	.. 207x NABS..	12	
	Push-button x-gang – standard, LS-design	.. 207x NABS..	12	
	Push-button x-gang – universal, A/AS-design	A 209x NABS..	16	
	Push-button x-gang – universal, CD 500	.. 209x NABS..	16	
	Push-button x-gang – universal, LS-design	.. 209x NABS..	16	
	Push-button 4-gang – universal, radio-controlled			
	CD 500	.. 2094 F..	20	
	LS-design	.. 2094 F..	20	
	Light mood push-button, A-design	A 2094 LZ..	22	
	Light mood push-button, CD 500	.. 2094 LZ..	22	
	Light mood push-button, LS-design	.. 2094 LZ..	22	
	Push-button modules – standard	407x TSM	24	
	Push-button modules – universal	409x TSM	24	
	Push-button extensionmodule universal	409x TSEM	25	
	Cover kits for A/AS-design	A 40x TSA..	26	
	Cover kits for CD 500	CD 40x TSA..	28	
	Cover kits for LS/FD designs	..40x TSA..	30	
	Room controller	Room controller display compact module	4093 KRM TSD	34
		Push-button extension module – universal	409x TSEM	35
		Cover kits for A/AS designs	A 4093 TSA..	36
Cover kits for CD 500		CD 4093 TSA..	37	
Cover kits for LS/FD designs		..4093 TSA..	38	
FD Room controller display, 4-gang		RCD 3094 M..	40	
FD Room controller display, 6-gang		RCD 3096 M..	40	
Cover for FD room controller display 4-/6-gang		FD 90x TSA..	42	
Room controller display RCD 3-gang		RCDx 2021..	43	
Room controller display RCD 4-gang		RCDx 2022..	43	
Room controller display RCD 5-gang		RCDx 2023..	43	
Room controller display RCD 6-gang		RCDx 2024..	44	
Room controller display RCD 8-gang		RCDx 2044..	44	
Push-buttons BCU		Push-button BCU 1-gang, switch position	2071.01 LED	47
		Push-button BCU 1-gang, neutral position	2071.02 LED	47
	Push-button BCU 2-gang, switch position	2072.01 LED	47	
	Push-button BCU 2-gang, neutral position	2072.02 LED	47	
	For the corresponding rockers see general Export catalogue.			
	Push-button BCU, WG 800, IP 44	807x LED W	48	
Physical sensors	PIR automatic switch 180°, standard	3180/3280	52	
	PIR automatic switch 180°, comfort	3180-1 A/3280-1 A	54	
	Presence detector, standard	3360	57	
	Presence detector 360°, universal	3360-1	58	
	Brightness controller, flush-mounted	2095 LUX	60	
	Brightness sensor, 3 channel	2160 REG	61	
	Room temperature controller	2178	62	
	Room temperature controller			
	with integrated push-button interface	2178 TS	63	
	Room autostat			
	with integrated push-button interface	2178 ORTS	65	
	CO2 Multi-Sensor	CO2 .. 2178..	67	

Device	Ref.-No.	Page	
Time switch, 4 channel	2154 REG	70	Time switch
Time switch, 2 channel	2152 REG	71	
Push-button interface, 2-gang	2076-2 T	72	Binary inputs
Push-button interface, 4-gang	2076-4 T	72	
Binary input universal, 4-gang, 110 – 230 V	2114 REG	73	
Binary input universal, 8-gang, 110 – 230 V	2118 REG	74	
Binary input universal, 6-gang, 24 V	2126 REG	75	
Weather station "home"	2224 WH	76	Analog inputs
Weather Station REG	2224 REG W	78	
Analog input, 4-gang	2114 REG A	80	
Analog input, extension modul, 4-gang	2214 REG AM	81	
Power supply for weather station and analog input	WSSV 10	82	
Combi sensor	WS 10 KS	82	Analog sensors for weather station
Combi sensor with DCF77 receiver	WS 10 KSDCF	82	
Wind sensor	WS 10 W	83	
Rain sensor	WS 10 R	84	
Brightness sensor	WS 10 H	85	
Dawn sensor	WS 10 D	85	
Temperature sensor	WS 10 T	85	
Power supply 640 mA	2002 REG	86	System Devices
Power supply 320 mA	2005 REG	87	
Uninterrupted power supply 640 MA	USV 640 MA	88	
Lead gel accumulator	BGA 12 AH	89	
Basic cable set	KSB 4	89	
Extension cable set	KSE 2	89	
Line coupler	2142 REG	90	
Data interface for SE installation (USB)	2130 USB REG	92	
Data interface for flush mounted (USB)	2130 USB	93	
IP Interface	IPS 100 REG	94	
IP Router	IPR 100 REG	95	
KNX Logic module	ABL/S2.1	95	
Switch actuator, 2-gang, 16 A	2302.16 REG HM	98	
Switch actuator, 4-gang, 16 A	2304.16 REG HM	99	
Switch actuator, 4-gang, 16 A, C-load	2304.16 REG CHM	100	
Switch actuator, 6-gang, 6 A	2136.6 REG	101	
Switch actuator, 8-gang, 16 A	2308.16 REG HM	102	
Switch actuator, 8-gang, 16 A, C-load	2308.16 REG CHM	103	
Switch actuator, 4-gang, 16 A / Blinds actuator 2-gang	2304.16 REG HE	104	
Switch actuator, 8-gang, 16 A / Blinds actuator 4-gang	2308.16 REG HE	106	
Switch actuator, 16-gang, 16 A / Blinds actuator 8 gang	2316.16 REG HE	108	

Contents

	Device	Ref.-No.	Page
Shutter/blinds	Shutter/blinds actuator, 4-gang, 6 A, 24 V DC	2424 REG H	110
	Shutter/blinds actuator, 2-gang, 230 V AC		
	1-gang 24 V DC	2502 REG HE	111
	Shutter/blinds actuator, 4-gang, 230 V AC		
	2-gang, 24 V DC	2504 REG HE	112
	Shutter/blinds actuator, 8-gang, 230 V AC		
	4-gang, 12 – 48 V DC	2508 REG HE	113
	Shutter actuator, 4-gang, 6 A, 230 V	2504 REG HER	114
Dimming	Universal dimming actuator, 1-gang	3801 REG HE	115
	Universal dimming actuator, 2-gang	3802 REG HE	116
	Universal dimming actuator, 4-gang	3804 REG HE	117
	DALI gateway	2097 REG HE	118
	Control unit, 3-gang, 1 – 10 V interface	2193 REG	120
Heating	Heating actuator, 6-gang	2136 REG HZ	121
	Fan coil actuator 2-gang	FCA 2 REG HE	122
	Room actuator 230 V	RA 23024 REG HE	124
Analog outputs	Analog output, 4-gang	2204.01 REG A	126
	Analog output extension, 4-gang	2204.01 REG AM	127
Heating	Valve drive	2176 SV	128
Flush-mounted actuators	Switch actuator, 1-gang, 16 A	2131.16 UP	129
	Switch actuator, 2-gang, 6 A	2132.6 UP	130
	Switch actuator, 1-gang, 3 A	2501 UP	131
	Heating actuator, 1-gang, 230 V	2501 HZ UP	132
	Room climate interface	2531 UP	133
	Universal dimming actuator, 1-gang	3210 UP	134
Communication	Telecommunication interface, wall mounted	2601	136
	Radio converter, 50 channels	2700 AP	137
Security	Alarm central unit	EAM 4000	138
	Components for EAM 4000		140

Device	Ref.-No.	Page	
Flat Panel PC 10"	SP 10 FAPVD-GB	144	Visualization Panel PC
Flat Panel PC 15"	SP 15 FAPVD-GB	144	
Flat Panel PC 19"	SP 19 FAPVD-GB	144	
Accessories Flat Panel PC		145	
Flat Panel PC 9" wide screen	SP 9 FAPVE-GB	146	
Accessories Flat Panel PC 9"		146	
Colour Touch Panel IP	FP 701 CT IP	147	Display
Design frames for FP 701 CT IP	FP ..781	147	
LCD Mini Panel	MT 701	148	
Frames for MT 701	R 24..	148	
Flush-mounted recessed box	EBG 24	148	
Signal panel	MBT 2424	149	
Facility-Pilot FAP Software			Visualization
Planner version	FAP-PL-3-GB	150	
50 data-point version	FAP-50-3-GB	150	
300 data-point version	FAP-300-3-GB	150	
Full version	FAP-Full-3-GB	150	
Client versions for network application	FAP-CL-3-GB	150	

AI	= Application interface
AM	= Application module
AP	= Surface mounted devices
BCU	= Bus coupling unit
PB	= Push-button
REG	= Series embodiment
SELV	= Safety extra low voltage
SU	= Units for data rails (series embodiment)
TC	= Telecontrol (Telecommunication interface)
UP	= Flush mounted devices

Abbreviations

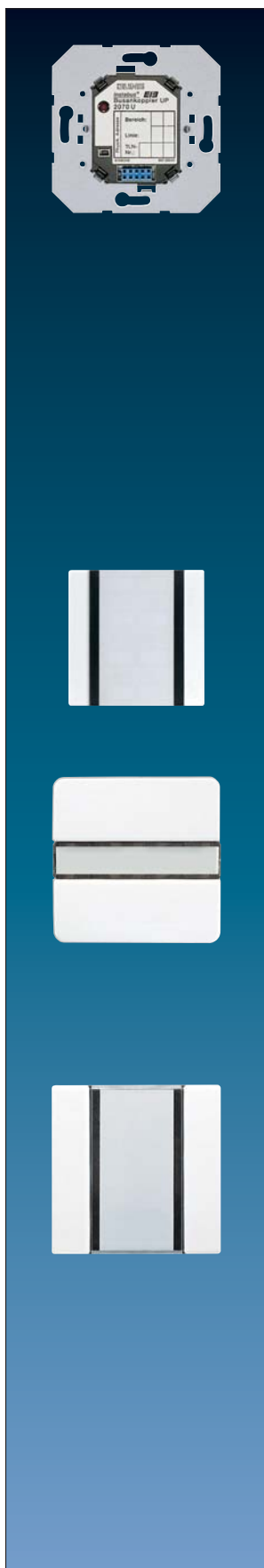

Ref.-no.

Bus coupling unit

screw fixing only, without claws
 ETS product family: System components
 Product type: Bus coupling unit

2070 U

**Standard push-button sensor
 for bus coupling unit ref.-no.: 2070 U**
1-gang

ETS product family: Push-button
 Product type: 1-gang push-button
 2 push-buttons
 1 green LED: operation indication
 1 red LED: status indication

for AS 500, A 500, A plus and A creation

ivory	A 2071 NABS
white	A 2071 NABS WW
aluminium	A 2071 NABS AL
black	A 2071 NABS SW

for CD 500 and CD plus

ivory	2071 NABS
white	CD 2071 NABS WW
grey	CD 2071 NABS GR
light grey	CD 2071 NABS LG
black	CD 2071 NABS SW

for the LS design ranges

ivory	LS 2071 NABS
white	LS 2071 NABS WW
light grey	LS 2071 NABS LG
black	LS 2071 NABS SW

Metal versions

aluminium (lacquered)	AL 2071 NABS
stainless steel	ES 2071 NABS
anthracite (lacquered)	AL 2071 NABS AN
chrome	GCR 2071 NABS
gold-coloured	GO 2071 NABS

Ref.-no.

**Standard push-button sensor
for bus coupling unit ref.-no.: 2070 U
2-gang**

ETS product family: Push-button
Product type: 2-gang push-button
4 push-buttons
1 green LED: operation indication
2 red LEDs: status indication

for AS 500, A 500, A plus and A creation

ivory	A 2072 NABS
white	A 2072 NABS WW
aluminium	A 2072 NABS AL
black	A 2072 NABS SW

for CD 500 and CD plus

ivory	2072 NABS
white	CD 2072 NABS WW
grey	CD 2072 NABS GR
light grey	CD 2072 NABS LG
black	CD 2072 NABS SW

for the LS design ranges

ivory	LS 2072 NABS
white	LS 2072 NABS WW
light grey	LS 2072 NABS LG
black	LS 2072 NABS SW

Metal versions

aluminium (lacquered)	AL 2072 NABS
stainless steel	ES 2072 NABS
anthracite (lacquered)	AL 2072 NABS AN
chrome	GCR 2072 NABS
gold-coloured	GO 2072 NABS

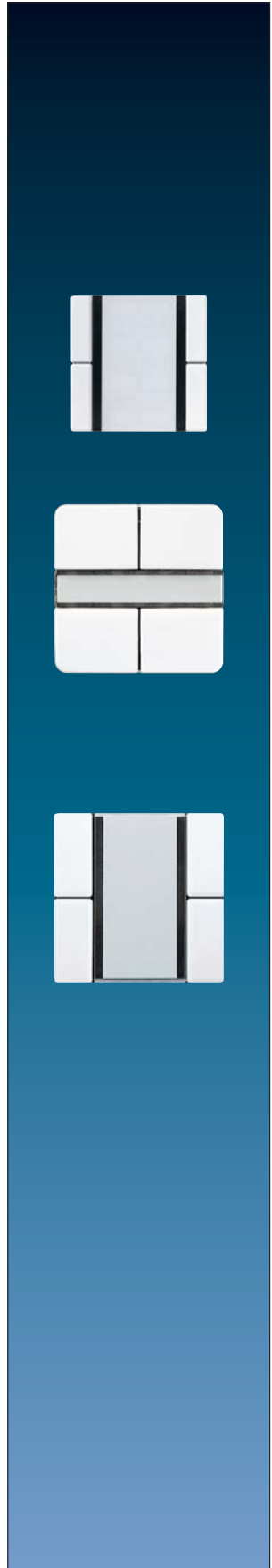

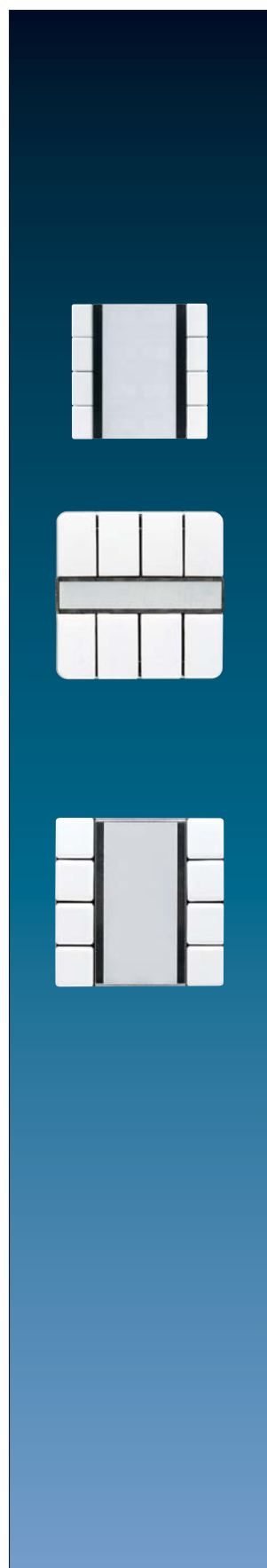

Ref.-no.

**Standard push-button sensor
for bus coupling unit ref.-no.: 2070 U
4-gang**

ETS product family: Push-button
Product type: 4-gang push-button
8 push-buttons
1 green LED: operation indication
4 red LEDs: status indication

for AS 500, A 500, A plus and A creation

ivory	A 2074 NABS
white	A 2074 NABS WW
aluminium	A 2074 NABS AL
black	A 2074 NABS SW

for CD 500 and CD plus

ivory	2074 NABS
white	CD 2074 NABS WW
grey	CD 2074 NABS GR
light grey	CD 2074 NABS LG
black	CD 2074 NABS SW

for the LS design ranges

ivory	LS 2074 NABS
white	LS 2074 NABS WW
light grey	LS 2074 NABS LG
black	LS 2074 NABS SW

Metal versions

aluminium (lacquered)	AL 2074 NABS
stainless steel	ES 2074 NABS
anthracite (lacquered)	AL 2074 NABS AN
chrome	GCR 2074 NABS
gold-coloured	GO 2074 NABS

Function

The push-button is plugged onto a flush mounted bus coupling unit. With an appropriate application program, it sends telegrams, for example to actuators for switching on/off lights, for dimming lights, for recalling and saving light scenes, or for moving blinds/shutters and for adjusting the louvres of blinds.

Status and operation indication is possible with LEDs.

The standard version is equipped with 1 operation LED and 1 status LED for each channel.

The 1-gang and 2-gang version enable a toggle mode.

The application of the 4-gang standard push-button is **always** selected for all 4 channels (4 x switching, 4 x dimming etc.)

Technical data

Power supply:	21 ... 32 V DC via flush-mounted BCU
Connection:	interface 2 x 5-pole
Power consumption:	max. 150 mW
Protection class:	III
Ambient temperature:	-5 ... +45 °C
Storage/transport temperature:	-25 ... +75 °C
Behaviour at voltage failure:	all object values are deleted





Ref.-no.

**Universal push-button sensor
for bus coupling unit ref.-no.: 2070 U
1-gang**

ETS product family: Push-button
Product type: 1-gang push-button
2 push-buttons
1 green LED: operation indication
2 red LEDs: status indication

for AS 500, A 500, A plus and A creation

ivory	A 2091 NABS
white	A 2091 NABS WW
aluminium	A 2091 NABS AL
black	A 2091 NABS SW

for CD 500 and CD plus

ivory	2091 NABS
white	CD 2091 NABS WW
grey	CD 2091 NABS GR
light grey	CD 2091 NABS LG
black	CD 2091 NABS SW

for the LS design ranges

ivory	LS 2091 NABS
white	LS 2091 NABS WW
light grey	LS 2091 NABS LG
black	LS 2091 NABS SW

Metal versions

aluminium (lacquered)	AL 2091 NABS
stainless steel	ES 2091 NABS
anthracite (lacquered)	AL 2091 NABS AN
chrome	GCR 2091 NABS
gold-coloured	GO 2091 NABS
Gold 24 carat	LS 2091 NABS GGO

Ref.-no.

**Universal push-button sensor
for bus coupling unit ref.-no.: 2070 U
2-gang**

ETS product family: Push-button
Product type: 2-gang push-button
4 push-buttons
1 green LED: operation indication
4 red LEDs: status indication

for AS 500, A 500, A plus and A creation

ivory	A 2092 NABS
white	A 2092 NABS WW
aluminium	A 2092 NABS AL
black	A 2092 NABS SW

for CD 500 and CD plus

ivory	2092 NABS
white	CD 2092 NABS WW
grey	CD 2092 NABS GR
light grey	CD 2092 NABS LG
black	CD 2092 NABS SW

for the LS design ranges

ivory	LS 2092 NABS
white	LS 2092 NABS WW
light grey	LS 2092 NABS LG
black	LS 2092 NABS SW

Metal versions

aluminium (lacquered)	AL 2092 NABS
stainless steel	ES 2092 NABS
anthracite (lacquered)	AL 2092 NABS AN
chrome	GCR 2092 NABS
gold-coloured	GO 2092 NABS
Gold 24 carat	LS 2092 NABS GGO



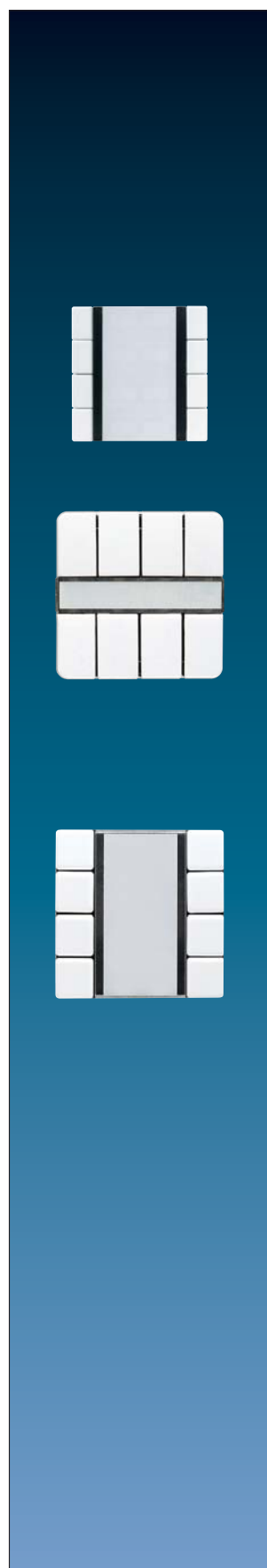

Ref.-no.

**Universal push-button sensor
for bus coupling unit ref.-no.: 2070 U
4-gang**

ETS product family: Push-button
Product type: 4-gang push-button
8 push-buttons
1 green LED: operation indication
8 red LEDs: status indication

for AS 500, A 500, A plus and A creation

ivory	A 2094 NABS
white	A 2094 NABS WW
aluminium	A 2094 NABS AL
black	A 2094 NABS SW

for CD 500 and CD plus

ivory	2094 NABS
white	CD 2094 NABS WW
grey	CD 2094 NABS GR
light grey	CD 2094 NABS LG
black	CD 2094 NABS SW

for the LS design ranges

ivory	LS 2094 NABS
white	LS 2094 NABS WW
light grey	LS 2094 NABS LG
black	LS 2094 NABS SW

Metal versions

aluminium (lacquered)	AL 2094 NABS
stainless steel	ES 2094 NABS
anthracite (lacquered)	AL 2094 NABS AN
chrome	GCR 2094 NABS
gold-coloured	GO 2094 NABS
Gold 24 carat	LS 2094 NABS GGO

Function

The push-button is plugged onto a flush mounted bus coupling unit.

With an appropriate application program, it sends telegrams, for example to actuators for switching on/off lights, for dimming lights, for recalling and saving light scenes, or for moving blinds/shutters and for adjusting the louvres of blinds. An universal push-button sensor can have various functions. Status and operation indication is possible with LEDs.

The universal version is equipped with 1 operation LED and 1 status LED for each button (2 for each channel).

Features

Switching

- Command at pressing/releasing of the push-button adjustable (ON, OFF, Toggle, no function).
- For a two level operation (toggle function), the objects of the relevant push-buttons must have the same group addresses.

Dimming

- Push-button function darker (OFF), brighter (ON) or darker/brighter (Toggle) adjustable.
- Time between dimming and switching and the dimming steps adjustable.
- Telegram repetition and stop telegram possible.
- For a correct function of the single level operation, the connected dimming actuator must send its status back also to the switching object of the push-button.
- With the single level operation only the switching object is retriggered internally and externally. The dimming object (dimming direction) is retriggered only internally so that in case of used extensions (2 or more sensors dim one lamp) the dimming direction will not always be changed at a new push action.
- For a two level operation, the objects of the relevant push-buttons must have the same group addresses.

Shutter/blinds

- Push-button function (Up, Down) and time between short and long-time operation adjustable.
- Louvres adjustment possible.
- This function supports the two level operation only. Therefore the "Step" and "Move" objects of the relevant push-buttons must have the same group addresses.

Value transmitter

- The push-button function, dimming value-, brightness value- or temperature value-transmitter as well as recalling and saving light scenes, can be parameterised.
 - Value adjustment via long push operation (dimming-, brightness-, temperature-value).
 - With value adjustment via long push operation, the new adjusted values are stored only within the RAM. After bus voltage drop or a bus reset, these values will be exchanged with the values programmed with the ETS.
- The value adjustment always is carried out in negative direction. After reaching the minimal value, it will continue automatically with the maximal value.

Technical data

Power supply:	21 ... 32 V DC via flush-mounted BCU
Connection:	interface 2 x 5-pole
Power consumption:	max. 150 mW
Protection class:	III
Ambient temperature:	-5 ... +45 °C
Storage/transport temperature:	-25 ... +75 °C
Behaviour at voltage failure:	all object values are deleted



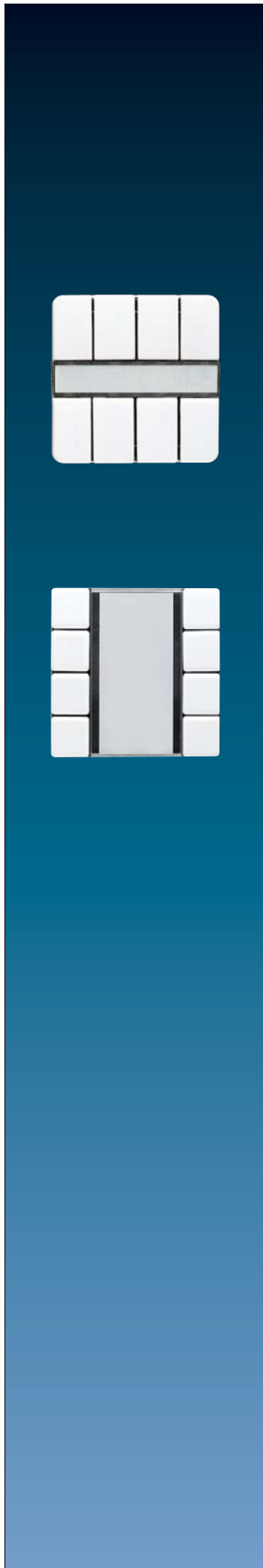

Ref.-no.

**Universal push-button sensor
for bus coupling unit ref.-no.: 2070 U
4-gang with radio receiver**

ETS product family: Push-button
Product type: 4-gang push-button
8 push-buttons
1 green LED: operation indication
1 red LED: radio transmission indication/teaching in mode indication

for CD 500 and CD plus

ivory	2094 F
white	CD 2094 F WW
grey	CD 2094 F GR
light grey	CD 2094 F LG
black	CD 2094 F SW

for the LS design ranges

ivory	LS 2094 F
white	LS 2094 F WW
light grey	LS 2094 F LG
black	LS 2094 F SW

Metal versions

aluminium (lacquered)	AL 2094 F
stainless steel	ES 2094 F
anthracite (lacquered)	AL 2094 F AN
gold-coloured	GO 2094 F

Function

The radio controlled 4-gang universal push-button is plugged onto a flush mounted bus coupling unit.

Its 8 rockers can be adjusted to different functions separately (switching, dimming, blind/shutter control or value transmitter). Depending on the adjusted function, it sends telegrams, e.g. to actuators for switching ON/OFF lights, for dimming lights, for recalling or saving light scenes, for moving shutters/blinds up or down and for adjusting the louvres and even to send brightness or temperature values (2 bytes) to the bus.

Due to the integrated radio receiver, no status LED's are available. In addition to the manual operation, the push button can integrate radio-controlled transmitters to the KNX.

The received radio signals will be transmitted to appropriate KNX telegrams.

The data transfer is unidirectional.

The following radio transmitters can be thought-in to the radio-controlled push-button:

- Hand-held transmitters: 48 KFH, 48 FH, 42 FH.
- Wall-mounted transmitters: 1-gang, 2-gang, 4-gang (the 4-gang transmitter can only control up to 4 channels of the 2094 F)
- Flat wall-mounted transmitters: 1-gang, 2-gang, 4-gang (the 4-gang transmitter can only control up to 4 channels of the 2094 F)
- Universal transmitter: FUS 22 UP
- Multifunction transmitter: FMS 4 UP.
- Observer: FW 180 WW
- Presence detector: FPM 360 WW

Technical data

Power supply:	21 ... 32 V DC via flush-mounted BCU
Connection:	interface 2 x 5-pole
Power consumption:	max. 150 mW
Protection class:	III
Ambient temperature:	-5 ... +45 °C
Storage/transport temperature:	-25 ... +75 °C
Behaviour at bus voltage failure:	no reaction
Behaviour at bus voltage recovery:	all object values are deleted

Input

Number of channels:	max. 8 radio transmitters with max. 12 channels each
Frequency:	433.42 MHz (ASK)
Reception area:	approx. 30 m (free field)



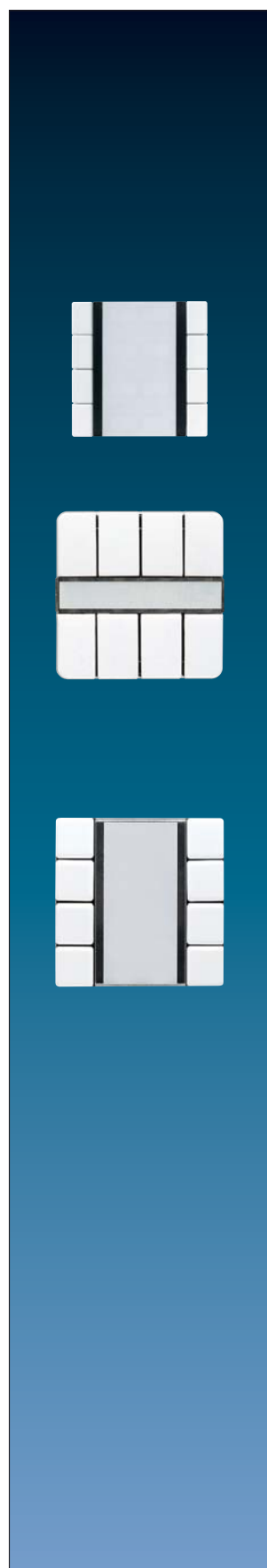

Ref.-no.

**Universal push-button sensor
for bus coupling unit ref.-no.: 2070 U
8-gang light scene**

ETS product family: Push-button
Product type: General push-button
8 push-buttons
1 green LED: operation indication
8 red LEDs: status indication

for AS 500, A 500, A plus and A creation

ivory	A 2094 LZ
white	A 2094 LZ WW
aluminium	A 2094 LZ AL
black	A 2094 LZ SW

for CD 500 and CD plus

ivory	2094 LZ
white	CD 2094 LZ WW
grey	CD 2094 LZ GR
light grey	CD 2094 LZ LG
black	CD 2094 LZ SW

for the LS design ranges

ivory	LS 2094 LZ
white	LS 2094 LZ WW
light grey	LS 2094 LZ LG
black	LS 2094 LZ SW

Metal versions

aluminium (lacquered)	AL 2094 LZ
stainless steel	ES 2094 LZ
anthracite (lacquered)	AL 2094 LZ AN
chrome	GCR 2094 LZ
gold-coloured	GO 2094 LZ

Function

The KNX light scene push-button stores up to 8 different light scenes from incandescent, low/high voltage halogen and fluorescent lamps. It is also possible to integrate blinds/shutters into the light scene control.

The individual light scenes are stored by pressing any of the 8 rockers for about 5 seconds. A LED signals the correct storage procedure. The brightness values for the different light scenes are recalled by pressing briefly. Operation from extension units (satellites) is possible as well. The light scene push-button has three different operation modes. Besides saving and recalling light scenes, it is also possible to switch/dim up to 8 different lighting groups. Hence, there is no necessity of two additional 4-gang push-buttons to adjust the brightness values or the switching conditions ON/OFF. Another mode facilitates a cascade of light scene push-buttons to have more than 8 different lighting groups integrated into the light scene control. Furthermore, special light effects can be realized in the cascade mode with endless operation.

Description of application Light Scene Mode

The push button can save and recall up to eight different light scenes. Each light scene consists of up to eight different object values. These are either brightness values (dimming actuator, 0 ... 255) or switch values (switch/shutter actuator, 0 or 1). By a short push (< 1 sec.) on the rocker, a light scene will be recalled. During the recall action of one light scene all brightness values or switching values of the dimming or switching actuators are transmitted. By a long push (> 5 sec.) on the rocker, an adjusted light scene will be saved. As an acknowledge the corresponding status LED switches on after about 5 sec. During the saving action all brightness values or switching values of the dimming or switching actuators are read out. To read out these values there has to be set an R-flag in the switch object of one switching actuator per group and an R-flag in the brightness value object of one dimming actuator per group. By the light scene extension input object, the light scenes can be recalled and saved from any satellite (other sensors, binary inputs, etc).

Description of application Switch/Dimming Mode

By a special "Three-Rocker-Grip" you can switch-over to the switch/dimming mode. That mode is indicated by the flashing operation LED (green). With that mode the push-button can be used as a switching or dimming sensor for up to eight lighting groups. The device automatically switches-over into the light scene mode as long as there is no manual toggling selected. The switch-over time can be parameterised. If the manual toggling is selected, the Three-Rocker-Grip has to be repeated.

Technical data

Power supply:	21 ... 32 V DC via flush-mounted BCU
Connection:	interface 2 x 5-pole
Power consumption:	max. 150 mW
Protection class:	III
Ambient temperature:	-5 ... +45 °C
Storage/transport temperature:	-25 ... +75 °C
Behaviour at voltage failure:	all object values are deleted

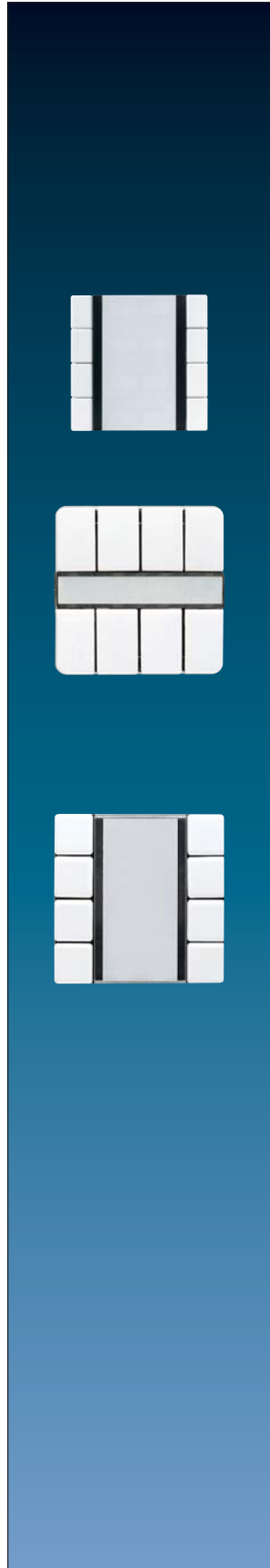

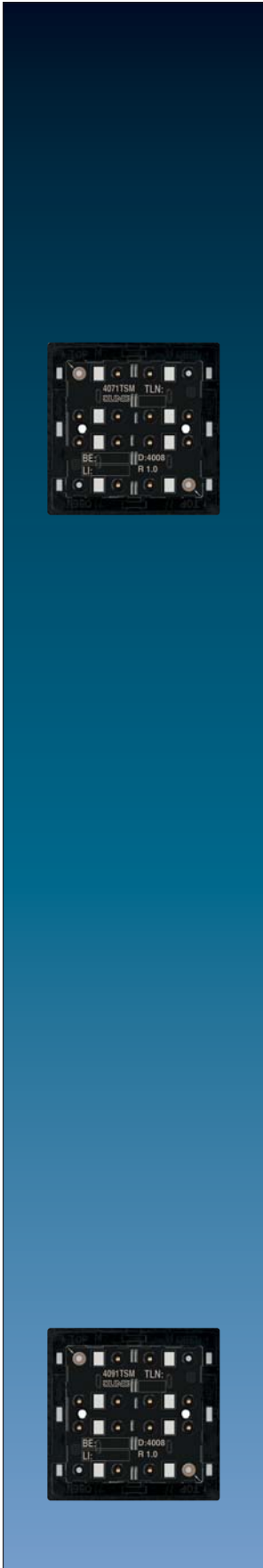

Ref.-no.

Standard push-button module with integrated BCU

to complete with cover kit of A-, CD- and LS ranges
 ETS product family: Push-button
 Product type: push-button
 1 blue LED: operation indication
 1 red LED: status indication

When pressing a button, the push-button module transmits telegrams to the KNX system. These may be telegrams for switching, push-button operation, dimming or for shutter control. It is also possible to program value-transmitting functions such as dimming value transmitter or as light-scene extension. A blue operation LED can serve as orientation light and the red LED indicates the switching status.

1-gang	1 red status indication LED	4071 TSM
2-gang	2 red status indication LEDs	4072 TSM
3-gang	3 red status indication LEDs	4073 TSM
4-gang	4 red status indication LEDs	4074 TSM

Universal push-button module with integrated BCU

to complete with cover kit of A-, CD- and LS ranges
 ETS product family: Push-button
 Product type: push-button
 1 blue LED: operation indication
 3 red LEDs: status indication

The square buttons can be used as one rocker or as two separate push-buttons (keys). The button can be operated either vertically or horizontally. The module has an integrated light scene controller for up to 8 light scenes and 8 groups. The device can be extended with an Universal push-button extension module (409x TSEM) Depending on the adjusted function, it sends telegrams, e.g. to actuators for :

- switching or dimming lights, recalling or saving light scenes
- shutters/blinds control and louvres adjustment
- value transmitter functions e.g. brightness or dimming values or temperature values
- two channel operation available on each push-button
- full surface operation

Each button has two red LEDs which can be:

- switched permanently ON or OFF
- used as status or operation indication
- used to indicate an alarm condition
- controlled by a separate object

1 blue LED which can be:

- switched permanently ON or OFF
- used as an orientating light
- controlled by a separate object

1-gang	2 red status indication LED	4091 TSM
2-gang	4 red status indication LEDs	4092 TSM
3-gang	6 red status indication LEDs	4093 TSM
4-gang	8 red status indication LEDs	4094 TSM

Ref.-no.

Universal push-button extension module

for the extension of up to 4 additional push-buttons for the universal push-button module and the RCD compact module. The extension module offers the same functionality as the universal push-button module (409X TSM) or the buttons of the RCD compact module (4093 KRM TSD).

Preferred installation: vertical
 Red LED for status indication

1-gang	2 red status indication LEDs	4091 TSEM
2-gang	4 red status indication LEDs	4092 TSEM
3-gang	6 red status indication LEDs	4093 TSEM
4-gang	8 red status indication LEDs	4094 TSEM

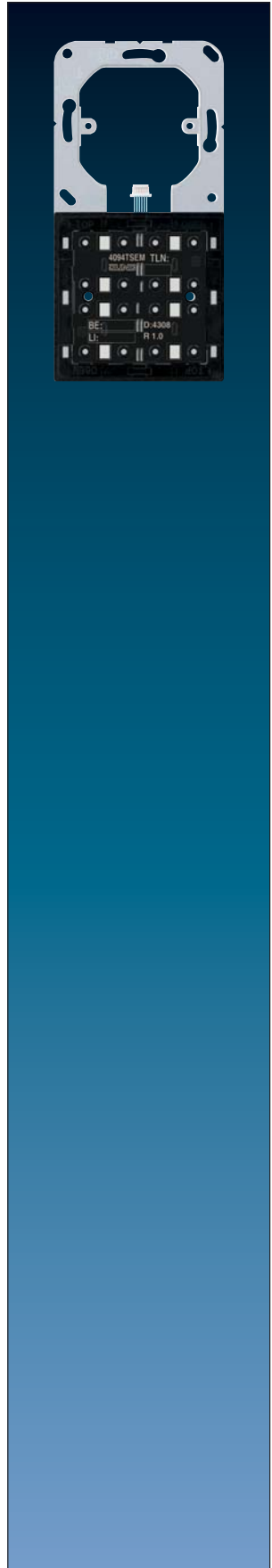

KNX

Cover kits for AS 500, A 500, A plus and A creation

Delivery of cover kits: 1 complete set per ref.-no.!

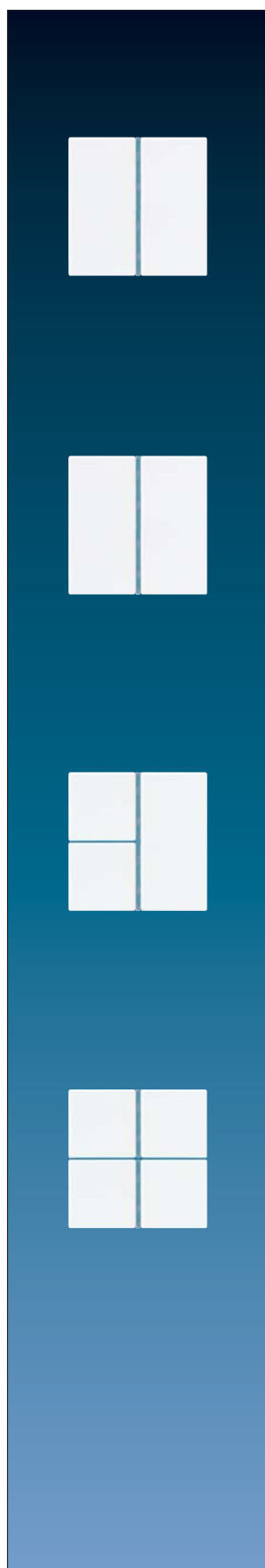

Ref.-no.

Cover kit 1-gang, complete

to clip on push-button module 1-gang:

Standard, ref.-no.: 4071 TSM

Universal, ref.-no.: 4091 TSM

Universal extension, ref.-no.: 4091 TSEM

ivory	A 401 TSA
white	A 401 TSA WW
aluminium	A 401 TSA AL
black	A 401 TSA SW

Cover kit 2-gang, complete

to clip on push-button module 2-gang:

Standard, ref.-no.: 4072 TSM

Universal, ref.-no.: 4092 TSM

Universal extension, ref.-no.: 4092 TSEM

ivory	A 402 TSA
white	A 402 TSA WW
aluminium	A 402 TSA AL
black	A 402 TSA SW

Cover kit 3-gang, complete

to clip on push-button module 3-gang:

Standard, ref.-no.: 4073 TSM

Universal, ref.-no.: 4093 TSM

Universal extension, ref.-no.: 4093 TSEM

ivory	A 403 TSA
white	A 403 TSA WW
aluminium	A 403 TSA AL
black	A 403 TSA SW

Cover kit 4-gang, complete

to clip on push-button module 4-gang:

Standard, ref.-no.: 4074 TSM

Universal, ref.-no.: 4094 TSM

Universal extension, ref.-no.: 4094 TSEM

ivory	A 404 TSA
white	A 404 TSA WW
aluminium	A 404 TSA AL
black	A 404 TSA SW

Professional inscription!

For further information see www.jung-label.de

Cover kits with symbols for AS 500, A 500, A plus and A creation

Delivery of covers with symbols: 1 piece per ref.-no.!

	Ref.-no.
Cover 1-gang	
with symbols ▲▼ to clip on push-button module 1-gang:	
Standard, ref.-no.: 4071 TSM	
Universal, ref.-no.: 4091 TSM	
Universal extension, ref.-no.: 4091 TSEM	
ivory	A 401 TSAP
white	A 401 TSAP WW
aluminium	A 401 TSAP AL
black	A 401 TSAP SW

Cover 2-gang	
with symbols ▲▼	
to exchange the covers of the cover kit 2-gang ref.-no.: A 402 TSA..	
and the right cover of the cover kit 3-gang ref.-no.: A 403 TSA..	
ivory	A 402 TSAP
white	A 402 TSAP WW
aluminium	A 402 TSAP AL
black	A 402 TSAP SW

Cover 4-gang	
with symbols ▲▼	
to exchange the top left cover of the cover kit 3-gang ref.-no.: A 403 TSA..	
and top left and bottom right cover of the cover kit 4-gang ref.-no.: A 404 TSA..	
to exchange the bottom right cover of the cover kit ref.-no.: A 4093 TSA..	
ivory	A 404 TSAP 14
white	A 404 TSAP WW 14
aluminium	A 404 TSAP AL 14
black	A 404 TSAP SW 14

Cover 4-gang	
with symbols ▲▼	
to exchange the bottom left cover of the cover kit 3-gang ref.-no.: A 403 TSA..	
and top right and bottom left cover of the cover kit 4-gang ref.-no.: A 404 TSA..	
to exchange the bottom left cover of the cover kit ref.-no.: A 4093 TSA..	
ivory	A 404 TSAP 23
white	A 404 TSAP WW 23
aluminium	A 404 TSAP AL 23
black	A 404 TSAP SW 23

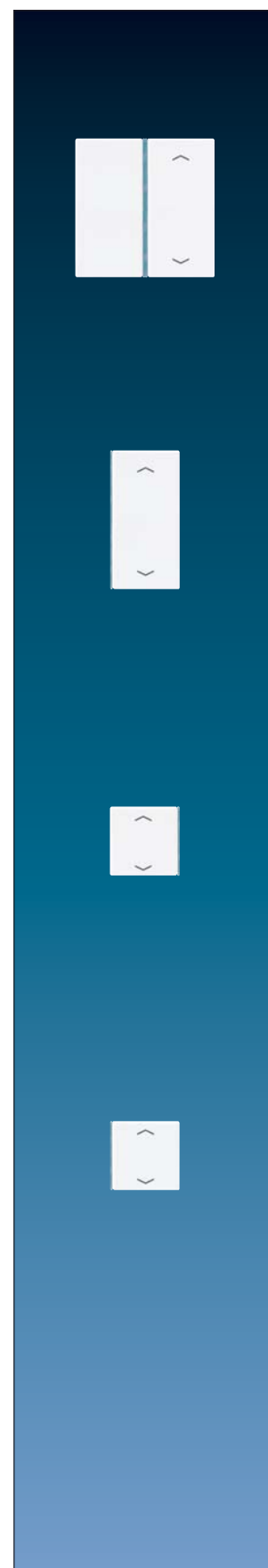

Cover kits for CD 500 and CD plus

Delivery of cover kits: 1 complete set per ref.-no.!

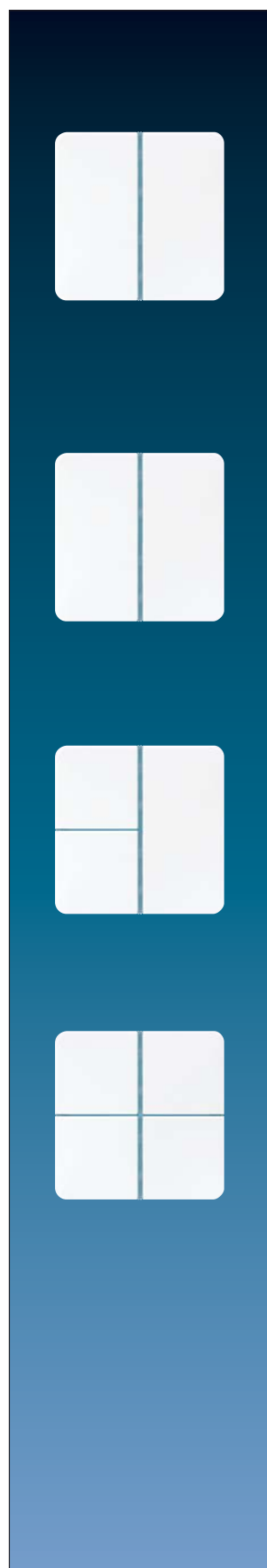

Ref.-no.

Cover kit 1-gang, complete

to clip on push-button module 1-gang:

Standard, ref.-no.: 4071 TSM

Universal, ref.-no.: 4091 TSM

Universal extension, ref.-no.: 4091 TSEM

ivory	CD 401 TSA
white	CD 401 TSA WW
grey	CD 401 TSA GR
light grey	CD 401 TSA LG
black	CD 401 TSA SW

Cover kit 2-gang, complete

to clip on push-button module 2-gang:

Standard, ref.-no.: 4072 TSM

Universal, ref.-no.: 4092 TSM

Universal extension, ref.-no.: 4092 TSEM

ivory	CD 402 TSA
white	CD 402 TSA WW
grey	CD 402 TSA GR
light grey	CD 402 TSA LG
black	CD 402 TSA SW

Cover kit 3-gang, complete

to clip on push-button module 3-gang:

Standard, ref.-no.: 4073 TSM

Universal, ref.-no.: 4093 TSM

Universal extension, ref.-no.: 4093 TSEM

ivory	CD 403 TSA
white	CD 403 TSA WW
grey	CD 403 TSA GR
light grey	CD 403 TSA LG
black	CD 403 TSA SW

Cover kit 4-gang, complete

to clip on push-button module 4-gang:

Standard, ref.-no.: 4074 TSM

Universal, ref.-no.: 4094 TSM

Universal extension, ref.-no.: 4094 TSEM

ivory	CD 404 TSA
white	CD 404 TSA WW
grey	CD 404 TSA GR
light grey	CD 404 TSA LG
black	CD 404 TSA SW

Professional inscription!

For further information see www.jung-label.de

Cover kits with symbols for CD 500 and CD plus

Delivery of covers with symbols: 1 piece per ref.-no.!

	Ref.-no.
Cover 1-gang	
with symbols ▲▼	
to clip on push-button module 1-gang:	
Standard, ref.-no.: 4071 TSM	
Universal, ref.-no.: 4091 TSM	
Universal extension, ref.-no.: 4091 TSEM	
ivory	CD 401 TSAP
white	CD 401 TSAP WW
grey	CD 401 TSAP GR
light grey	CD 401 TSAP LG
black	CD 401 TSAP SW

Cover 2-gang	
with symbols ▲▼	
to exchange the covers of the cover kit 2-gang ref.-no.: CD 402 TSA..	
and the right cover of the cover kit 3-gang ref.-no.: CD 403 TSA..	
ivory	CD 402 TSAP
white	CD 402 TSAP WW
grey	CD 402 TSAP GR
light grey	CD 402 TSAP LG
black	CD 402 TSAP SW

Cover 4-gang	
with symbols ▲▼	
to exchange the top left cover of the cover kit 3-gang ref.-no.: CD 403 TSA..	
and top left and bottom right cover of the cover kit 4-gang ref.-no.: CD 404 TSA..	
ivory	CD 404 TSAP 14
white	CD 404 TSAP WW 14
grey	CD 404 TSAP GR 14
light grey	CD 404 TSAP LG 14
black	CD 404 TSAP SW 14

Cover 4-gang	
with symbols ▲▼	
to exchange the bottom left cover of the cover kit 3-gang ref.-no.: CD 403 TSA..	
and top right and bottom left cover of the cover kit 4-gang ref.-no.: CD 404 TSA..	
ivory	CD 404 TSAP 23
white	CD 404 TSAP WW 23
grey	CD 404 TSAP GR 23
light grey	CD 404 TSAP LG 23
black	CD 404 TSAP SW 23

Adapter frame	
(Spare part)	
to combine push-button modules with CD 500 / CD plus	
Also included in delivery of modules.	
	CD 4 AR

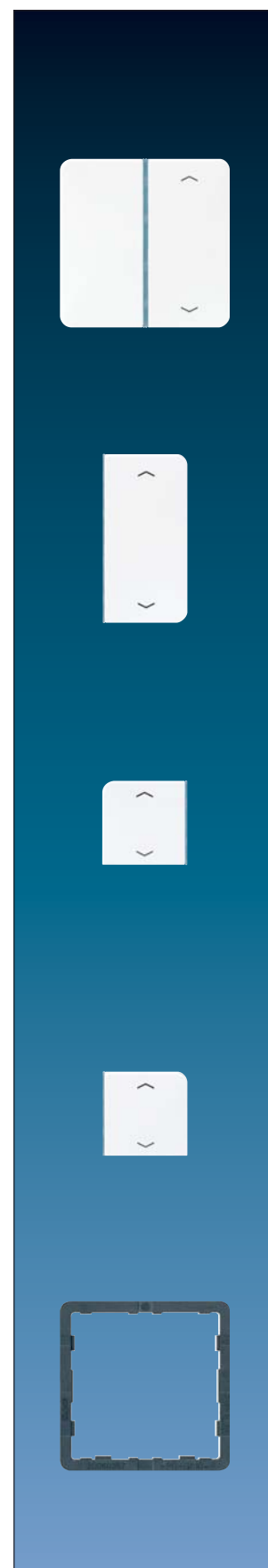

Delivery of cover kits: 1 complete set per ref.-no.!



	Ref.-no.
Cover kit 1-gang, complete	
to clip on push-button module 1-gang:	
Standard, ref.-no.: 4071 TSM • Universal, ref.-no.: 4091 TSM	
Universal extension, ref.-no.: 4091 TSEM	
ivory	LS 401 TSA
white	LS 401 TSA WW
light grey	LS 401 TSA LG
black	LS 401 TSA SW
Metal versions	
aluminium	AL 2401 TSA
stainless steel	ES 2401 TSA
anthracite (aluminium lacquered)	AL 2401 TSA AN
Cover kit 2-gang, complete	
to clip on push-button module 2-gang:	
Standard, ref.-no.: 4072 TSM • Universal, ref.-no.: 4092 TSM	
Universal extension, ref.-no.: 4092 TSEM	
ivory	LS 402 TSA
white	LS 402 TSA WW
light grey	LS 402 TSA LG
black	LS 402 TSA SW
Metal versions	
aluminium	AL 2402 TSA
stainless steel	ES 2402 TSA
anthracite (aluminium lacquered)	AL 2402 TSA AN
Cover kit 3-gang, complete	
to clip on push-button module 3-gang:	
Standard, ref.-no.: 4073 TSM • Universal, ref.-no.: 4093 TSM	
Universal extension, ref.-no.: 4093 TSEM	
ivory	LS 403 TSA
white	LS 403 TSA WW
light grey	LS 403 TSA LG
black	LS 403 TSA SW
Metal versions	
aluminium	AL 2403 TSA
stainless steel	ES 2403 TSA
anthracite (aluminium lacquered)	AL 2403 TSA AN
Cover kit 4-gang, complete	
to clip on push-button module 4-gang:	
Standard, ref.-no.: 4074 TSM • Universal, ref.-no.: 4094 TSM	
Universal extension, ref.-no.: 4094 TSEM	
ivory	LS 404 TSA
white	LS 404 TSA WW
light grey	LS 404 TSA LG
black	LS 404 TSA SW
Metal versions	
aluminium	AL 2404 TSA
stainless steel	ES 2404 TSA
anthracite (aluminium lacquered)	AL 2404 TSA AN

Professional inscription!

For further information see www.jung-label.de

Cover kits with symbols for LS design ranges and Flat Design

Delivery of covers with symbols: 1 piece per ref.-no.!

	Ref.-no.
Cover 1-gang	
with symbols ▲▼	
to clip on push-button module 1-gang:	
Standard, ref.-no.: 4071 TSM • Universal, ref.-no.: 4091 TSM	
Universal extension, ref.-no.: 4091 TSEM	
ivory	LS 401 TSAP
white	LS 401 TSAP WW
light grey	LS 401 TSAP LG
black	LS 401 TSAP SW
Metal versions	
aluminium	AL 2401 TSAP
stainless steel	ES 2401 TSAP
anthracite (aluminium lacquered)	AL 2401 TSAP AN
Cover 2-gang	
with symbols ▲▼	
to exchange the covers of the cover kit 2-gang ref.-no.: ..402 TSA..	
and the right cover of the cover kit 3-gang ref.-no.: ..403 TSA.. in the LS design ranges	
ivory	LS 402 TSAP
white	LS 402 TSAP WW
light grey	LS 402 TSAP LG
black	LS 402 TSAP SW
Metal versions	
aluminium	AL 2402 TSAP
stainless steel	ES 2402 TSAP
anthracite (aluminium lacquered)	AL 2402 TSAP AN
Cover 4-gang	
with symbols ▲▼	
to exchange the top left cover of the cover kit 3-gang ref.-no.: ..403 TSA..	
and top left and bottom right cover of the cover kit 4-gang ref.-no.: ..404 TSA.. in the LS design ranges	
ivory	LS 404 TSAP 14
white	LS 404 TSAP WW 14
light grey	LS 404 TSAP LG 14
black	LS 404 TSAP SW 14
Metal versions	
aluminium	AL 2404 TSAP 14
stainless steel	ES 2404 TSAP 14
anthracite (aluminium lacquered)	AL 2404 TSAP AN 14
Cover 4-gang	
with symbols ▲▼	
to exchange the bottom left cover of the cover kit 3-gang ref.-no.: ..403 TSA..	
and top right and bottom left cover of the cover kit 4-gang ref.-no.: ..404 TSA.. in the LS design ranges	
ivory	LS 404 TSAP 23
white	LS 404 TSAP WW 23
light grey	LS 404 TSAP LG 23
black	LS 404 TSAP SW 23
Metal versions	
aluminium	AL 2404 TSAP 23
stainless steel	ES 2404 TSAP 23
anthracite (aluminium lacquered)	AL 2404 TSAP AN 23
Adapter frame (Spare part)	
to combine push-button modules with LS design ranges and Flat Design	
Also included in delivery of modules.	
	LS 4 AR

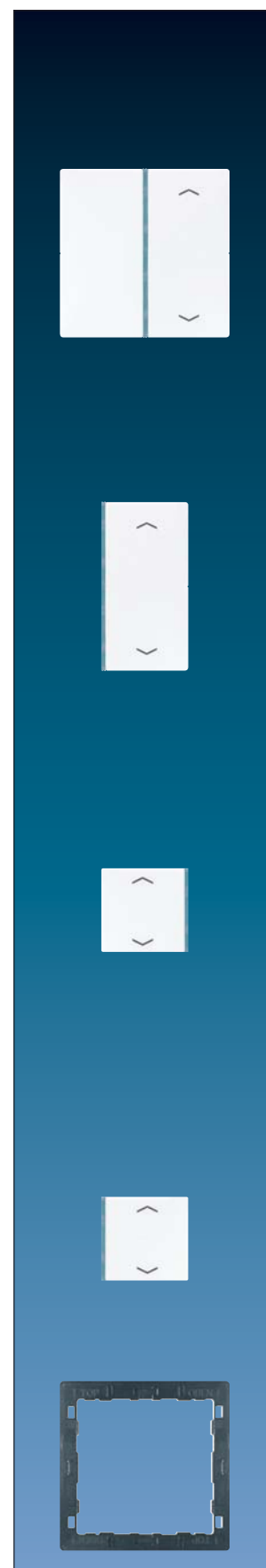

KNX Compact room controller

The Compact room controller with integrated bus coupler enables the central regulation of the lighting, temperature and blinds as a compact room control device. The device has three large operating surfaces for convenient switching, dimming or for blind control. If required, you can also program valuator functions such as dimming, temperature or brightness values and light scene inputs.

For rapid information: you can clearly read the room or setpoint temperature from the inverted monitor with illuminated, digital display as well as the current time in connection with the KNX timer. And for increased flexibility, the connection of the extension module enables an expansion of up to four different push-buttons. The push-buttons are supplied as complete sets for quick installation.



LS 990 version



Compact module combined with extension module in a 2-gang frame



CD 500 version



Acreation version

JUNG



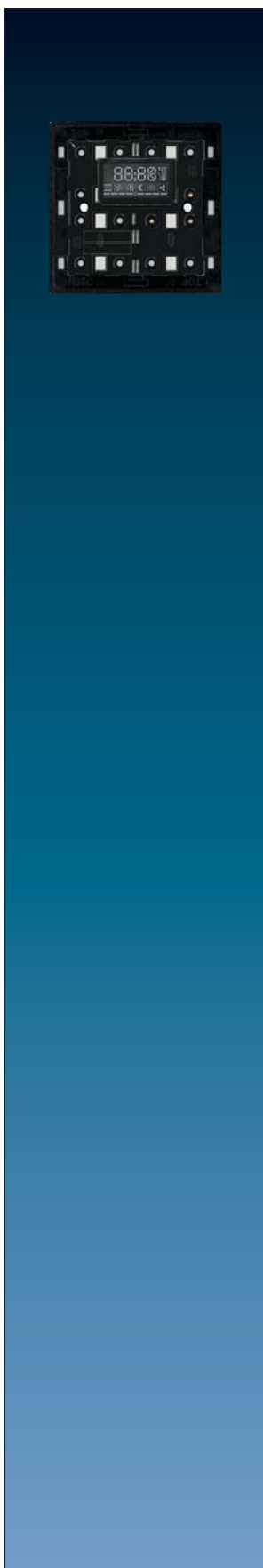

Ref.-no.

Room controller display compact module

(BCU integrated)

ETS product family: Heating, A/C, ventilation or push-button

Product type: regulator

1 blue operation LED

4 red status LEDs

Adapter frames are included in delivery: ref.-no. LS 4 AR for LS design ranges (pre-mounted) and ref.-no. CD 4 AR for CD 500

4093 KRM TS D

recommended mounting height: 1.5 m

Intended use

- Measurement and feedback control of the room temperature
- Operation of loads, e.g. light on/off, dimming, blinds up/down, brightness values, temperatures, recalling and saving light scenes, etc.
- Fan coil application with up to 8 fan speeds and auto function.
- Installation in wall box according to DIN 49 073

Product characteristics

All buttons can be assigned with functions for controller operation.

- Four red status LEDs
- A blue operation LED as an orientation light and to indicate the programming status
- Integrated bus coupling unit
- Connection of push-button extension module
- Integrated room temperature controller
- Room temperature control with setpoint value specification
- Display of room or setpoint temperature
- Display of outdoor temperature – with external sensor, e.g. weather station
- Display of time, in conjunction with KNX time encoder
- Push-button functions for switching, dimming, blinds control, value transmitter, light scenes, etc.
- Push-button or rocker function, vertical or horizontal
- Second operation level for display and temperature settings.

Note: Do not mount the device next to heat sources due to the influence of the integrated temperature sensor.

Technical data

KNX supply:	DC 21 ... 32 VSELV
Current consumption KNX:	max. 20 mA
Connection, KNX:	terminal
Protection class:	III
Ambient temperature:	-5 ...+45 °C
Storage/transport temperature:	-20 ... +75 °C

Delivery of cover kits: 1 complete set per ref.-no!
 Delivery of covers with symbols: 1 piece per ref.-no.!

Ref.-no.

Universal push-button extension module

for the extension of up to 4 additional push-buttons for the devices:

- Universal push-button module
- RCD Compact module

preferred installation: vertical

Adapter frames are included in delivery: ref.-no. LS 4 AR for LS design ranges
 (pre-mounted) and ref.-no. CD 4 AR for CD 500

red LED: status indication

1-gang	4091 TSEM
2-gang	4092 TSEM
3-gang	4093 TSEM
4-gang	4094 TSEM

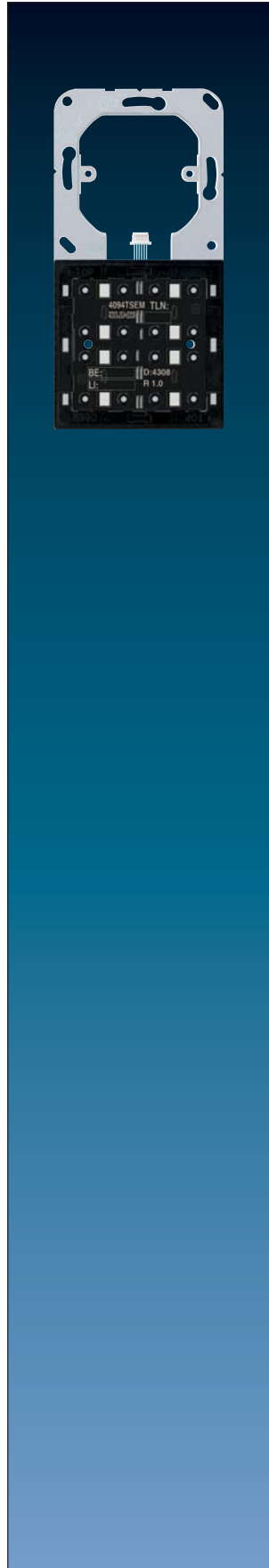

KNX

Cover kits for AS 500, A 500, A plus and A creation

Delivery of cover kits: 1 complete set per ref.-no.!

Delivery of covers with symbols: 1 piece per ref.-no.!

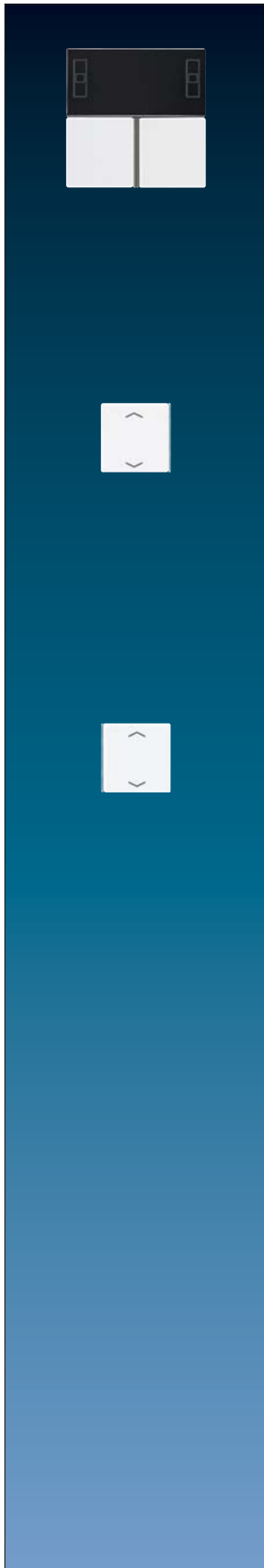

Ref.-no.

Cover kit, complete

to clip on room controller display compact module ref.-no.: 4093 KRM TS D

ivory	A 4093 TSA
white	A 4093 TSA WW
aluminium	A 4093 TSA AL
black	A 4093 TSA SW

Cover 4-gang

with symbols ▲▼

to exchange the bottom right cover of the cover kit ref.-no.: A 4093 TSA..

ivory	A 404 TSAP 14
white	A 404 TSAP WW 14
aluminium	A 404 TSAP AL 14
black	A 404 TSAP SW 14

Cover 4-gang

with symbols ▲▼

to exchange the bottom left cover of the cover kit ref.-no.: A 4093 TSA..

ivory	A 404 TSAP 23
white	A 404 TSAP WW 23
aluminium	A 404 TSAP AL 23
black	A 404 TSAP SW 23

Professional inscription!

For further information see www.jung-label.de

Cover kits for CD 500 and CD plus

Delivery of cover kits: 1 complete set per ref.-no.!

Delivery of covers with symbols: 1 piece per ref.-no.!

	Ref.-no.
Cover kit, complete	
to clip on room controller display compact module ref.-no.: 4093 KRM TS D	
ivory	CD 4093 TSA
white	CD 4093 TSA WW
grey	CD 4093 TSA GR
light grey	CD 4093 TSA LG
black	CD 4093 TSA SW

**Cover 4-gang
with symbols ▲▼**

to exchange the bottom right cover of the cover kit ref.-no.: CD 4093 TSA..

ivory	CD 404 TSAP 14
white	CD 404 TSAP WW 14
grey	CD 404 TSAP GR 14
light grey	CD 404 TSAP LG 14
black	CD 404 TSAP SW 14

**Cover 4-gang
with symbols ▲▼**

to exchange the bottom left cover of the cover kit ref.-no.: CD 4093 TSA..

ivory	CD 404 TSAP 23
white	CD 404 TSAP WW 23
grey	CD 404 TSAP GR 23
light grey	CD 404 TSAP LG 23
black	CD 404 TSAP SW 23

Adapter frame

(Spare part)

to combine push-button modules with CD 500 / CD plus

Also included in delivery of modules.

CD 4 AR

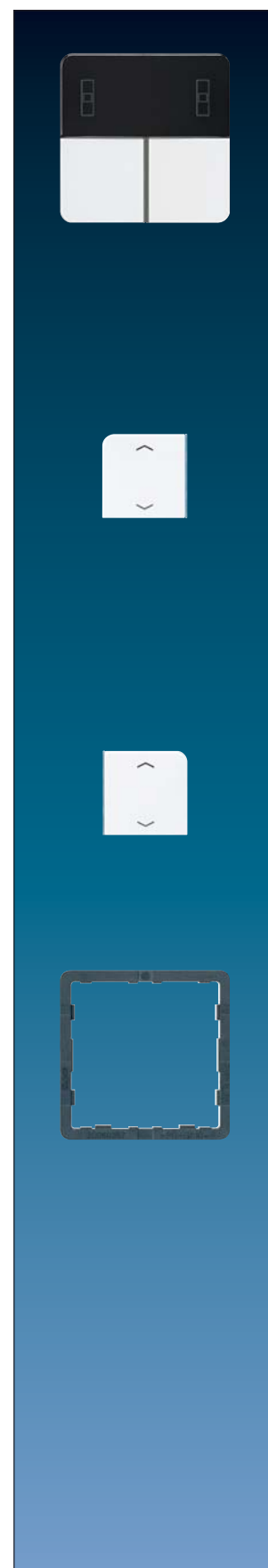

Professional inscription!

For further information see www.jung-label.de

KNX

Cover kits for LS design ranges and Flat Design



Ref.-no.

Cover kit, complete

to clip on room controller display compact module ref.-no.: 4093 KRM TS D

ivory	LS 4093 TSA
white	LS 4093 TSA WW
light grey	LS 4093 TSA LG
black	LS 4093 TSA SW

Metal versions

aluminium	AL 4093 TSA
stainless steel	ES 4093 TSA
anthracite (aluminium lacquered)	AL 4093 TSA AN

Cover 4-gang with symbols ▲▼

to exchange the bottom right cover of the cover kit ref.-no.: .. 4093 TSA .. in the LS design ranges

ivory	LS 404 TSAP 14
white	LS 404 TSAP WW 14
light grey	LS 404 TSAP LG 14
black	LS 404 TSAP SW 14

Metal versions

aluminium	AL 2404 TSAP 14
stainless steel	ES 2404 TSAP 14
anthracite (aluminium lacquered)	AL 2404 TSAP AN 14

Cover 4-gang with symbols ▲▼

to exchange the bottom left cover of the cover kit ref.-no.: .. 4093 TSA .. in the LS design range

ivory	LS 404 TSAP 23
white	LS 404 TSAP WW 23
light grey	LS 404 TSAP LG 23
black	LS 404 TSAP SW 23

Metal versions

aluminium	AL 2404 TSAP 23
stainless steel	ES 2404 TSAP 23
anthracite (aluminium lacquered)	AL 2404 TSAP AN 23

Adapter frame

(Spare part)

to combine push-button modules with LS design ranges and Flat Design

Also included in delivery of modules.

LS 4 AR

Professional inscription!

For further information see www.jung-label.de

Room Controller Display

The RCD in Flat Design is available as a 4 or 6-gang device with a maximum of 24 functions. The innovative device enables the users to conveniently monitor and control all switching operations for lights, blinds or rolling shutters, heating and air conditioning systems.

The Room Controller Display shows its advanced design for convenience and handling. It offers a freely-programmable graphic display for one, two or three lines of full text for alarm messages or music titles. The symbols on the display provide information on the basic functions such as heating or cooling at a glance. In spite of this remarkable functional variety, the unit is easy to use. An advantage of the practical FD control concept, which works according to the easy-to-understand principle of „Pressing the button at the top, bottom, right, left or centre“. The corresponding button covers are available as required, without labeling, with symbols or as solid surface for your own labels. This allows the user to specify their own requirements. The FD RCD has an elegant, attractive appearance, enhanced by the Flat Design. The integrated bus coupling unit allows it to be installed in a single flush wall box.





Ref.-no.

FD room controller display (FD RCD), 4-gang

(BCU integrated)
ETS product family: Heating, A/C, ventilation or push-button
Product type: Regulator
1 blue operation LED
8 red status LEDs

ivory	RCD 3094 M
white	RCD 3094 M WW
light grey	RCD 3094 M LG
Metal versions	
aluminium	RCD AL 3094 M
stainless steel	RCD ES 3094 M
anthracite (aluminium lacquered)	RCD AL 3094 M AN

FD room controller display (FD RCD), 6-gang

(BCU integrated)
ETS product family: Heating, A/C, ventilation or push-button
Product type: Regulator
1 blue operation LED
12 red status LEDs

ivory	RCD 3096 M
white	RCD 3096 M WW
light grey	RCD 3096 M LG
Metal versions	
aluminium	RCD AL 3096 M
stainless steel	RCD ES 3096 M
anthracite (aluminium lacquered)	RCD AL 3096 M AN

Intended use

- Operation of loads, e.g. lights on/off, dimming, blinds/shutters up/down, brightness values, temperatures, recalling and saving light scenes etc.
- Room temperature control
- Fan coil application with up to 8 fan speeds and auto function
- Illuminated LCD display is freely programmable (14 byte string text) with up to 4 pages and up to 3 lines per page
- Installation in mounting box according to DIN 49073

Product characteristics

- Push-button sensor functions switching, dimming, blind/shutter control, value transmitter, light scene, etc.
- Push-button or rockers function, vertical or horizontal
- Two red LEDs per control key as status or key-press indicators
- Display of values and texts
- Integrated room temperature controller
- Room temperature control with setpoint value specification
- Display of room and setpoint temperature, time and date in conjunction with KNX time server
- Indication of outside temperature (only with external sensor)
- Integrated bus coupling unit
- In combination with Facility Pilot and e.g. Squeezebox® multi-room control from Logitech: music play control, display of music titles, artists, etc.
- Display unit for the KNX central alarm unit
- Second operation level for display and temperature settings
- Various symbols and icons are available in order to design the display pages
- Display page recall via external values

Technical data

KNX supply:	DC 21 ... 32 V SELV
Current consumption KNX:	max. 20 mA
Connection, KNX:	terminal
Protection class:	III
Ambient temperature:	-5 ... +45 °C
Storage/transport temperature:	-20 ... +75 °C

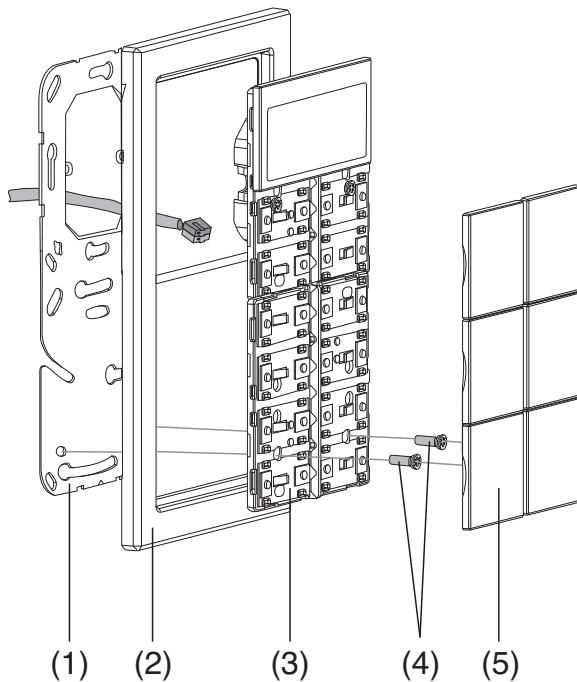
Connection and mounting of the FDRCD ..309x M..:

- Metal supporting frame (1) to be mounted on a wall box. Marking "TOP" = on top; "A" in front for FD frame or "B" in front for LS 990, LS plus frame.
- Attach design-frame (2) onto the supporting frame.
- Connect FD RCD module (3) with standard bus connector to the KNX and attach it to the supporting frame.
- When mounting on a single wall box (no wall box under the lower part) generate space for the lower plastic screws in the wall, approx. 10 mm (e.g. drill 6 mm). Use the supporting frame for positioning.
- Fix the FD RCD module (3) to the supporting frame by means of the plastic screws (4) → dismantling / burglar protection.
Screw the plastic screws slightly only.
- Download the physical address into the device before mounting the design covers (5).

Note: Do not mount the device next to heat sources due to the influence of the integrated temperature sensor.



Delivery of covers: 1 piece per ref.-no.!

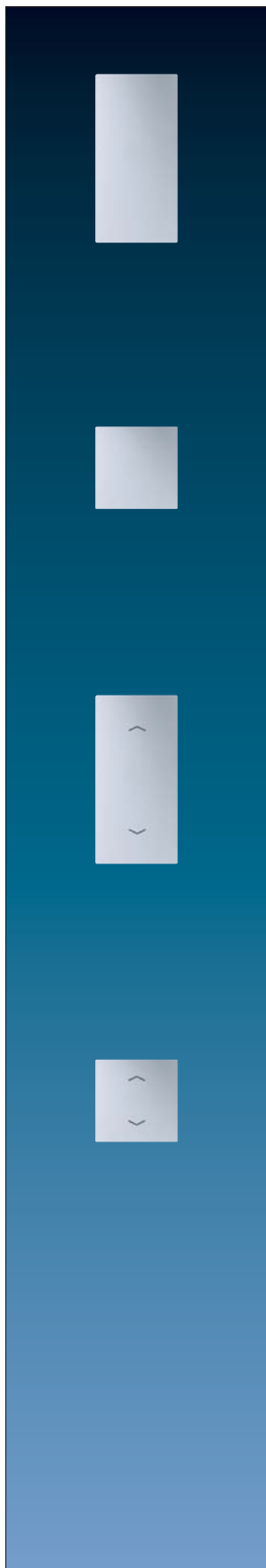

	Ref.-no.
Cover for FD room controller display, 2-gang	
to clip on room controller display 4-gang (lower part) ref.-no.: RCD .. 3094 M ..	
ivory	FD 902 TSA
white	FD 902 TSA WW
light grey	FD 902 TSA LG
Metal versions	
aluminium	FDAL 2902 TSA
stainless steel	FDES 2902 TSA
anthracite (aluminium lacquered)	FDAL 2902 TSA AN
Cover for FD room controller display, 4-gang	
to clip on room controller display 4-gang (upper part) ref.-no.: RCD .. 3094 M ..	
to clip on room controller display 6-gang ref.-no.: RCD .. 3096 M ..	
ivory	FD 904 TSA
white	FD 904 TSA WW
light grey	FD 904 TSA LG
Metal versions	
aluminium	FDAL 2904 TSA
stainless steel	FDES 2904 TSA
anthracite (aluminium lacquered)	FDAL 2904 TSA AN
Cover for FD room controller display, 2-gang with symbols ▲▼	
to clip on room controller display 4-gang (lower part) ref.-no.: RCD .. 3094 M ..	
ivory	FD 902 TSAP
white	FD 902 TSAP WW
light grey	FD 902 TSAP LG
Metal versions	
aluminium	FDAL 2902 TSAP
stainless steel	FDES 2902 TSAP
anthracite (aluminium lacquered)	FDAL 2902 TSAP AN
Cover for FD room controller display, 4-gang with symbols ▲▼	
to clip on room controller display 4-gang (upper part) ref.-no.: RCD .. 3094 M ..	
to clip on room controller display 6-gang ref.-no.: RCD .. 3096 M ..	
ivory	FD 904 TSAP
white	FD 904 TSAP WW
light grey	FD 904 TSAP LG
Metal versions	
aluminium	FDAL 2904 TSAP
stainless steel	FDES 2904 TSAP
anthracite (aluminium lacquered)	FDAL 2904 TSAP AN

Professional inscription!
 For further information see www.jung-label.de

Ref.-no.

Room controller display, 3-gang

(BCU integrated)

Display illuminated, either permanently or when pressing any push-button.

ETS product family: Heating, A/C, ventilation or push-button

Product type: regulator

1 green operation LED

6 red status LEDs

ivory	RCD 2021
white	RCD 2021 WW
light grey	RCD 2021 LG
black	RCD 2021 SW

Metal versions

aluminium (lacquered)	RCD AL 2021
stainless steel	RCD ES 2021
anthracite (lacquered)	RCD AL 2021 AN

Room controller display, 4-gang

ETS product family: Heating, A/C, ventilation or push-button

Product type: regulator

1 green operation LED

8 red status LEDs

ivory	RCD 2022
white	RCD 2022 WW
light grey	RCD 2022 LG
black	RCD 2022 SW

Metal versions

aluminium (lacquered)	RCD AL 2022
stainless steel	RCD ES 2022
anthracite (lacquered)	RCD AL 2022 AN

Room controller display, 5-gang

ETS product family: Heating, A/C, ventilation or push-button

Product type: regulator

1 green operation LED

10 red status LEDs

ivory	RCD 2023
white	RCD 2023 WW
light grey	RCD 2023 LG
black	RCD 2023 SW

Metal versions

aluminium (lacquered)	RCD AL 2023
stainless steel	RCD ES 2023
anthracite (lacquered)	RCD AL 2023 AN





Ref.-no.

Room controller display, 6-gang

ETS product family: Heating, A/C, ventilation or push-button

Product type: regulator

1 green operation LED

12 red status LEDs

ivory	RCD 2024
white	RCD 2024 WW
light grey	RCD 2024 LG
black	RCD 2024 SW

Metal versions

aluminium (lacquered)	RCD AL 2024
stainless steel	RCD ES 2024
anthracite (lacquered)	RCD AL 2024 AN

Room controller display, 8-gang

ETS product family: Heating, A/C, ventilation or push-button

Product type: regulator

1 green operation LED

16 red status LEDs

ivory	RCD 2044
white	RCD 2044 WW
light grey	RCD 2044 LG
black	RCD 2044 SW

Metal versions

aluminium (lacquered)	RCD AL 2044
stainless steel	RCD ES 2044
anthracite (lacquered)	RCD AL 2044 AN

Transparent cover with inlay

for room controller displays "RCD" ref.-no.: RCD 20.., RCD .. 20..

(Spare part)

paper inlay ivory	RCD 20 NA
paper inlay white	RCD 20 NA WW
paper inlay light grey	RCD 20 NA LG
for devices in black, aluminium and anthracite	
paper inlay aluminium	RCD AL 20 NA
for devices in stainless steel	
paper inlay stainless steel	RCD ES 20 NA

Intended use

- Operation of loads, e.g. lights on/off, dimming, blinds/shutters up/down, brightness values, temperatures, recalling and saving light scenes etc.
- Room temperature control
- Fan coil application with up to 4 fan speeds and auto function
- Illuminated LCD display with up to 5 different value indications
- Installation in mounting box according to DIN 49073

Product characteristics

- Push-button sensor functions switching, dimming, blind/shutter control, value transmitter, light scene, etc.
- Push-button or rockers function
- Two red LEDs per control key as status or key-press indicators
- Integrated room temperature controller
- Room temperature control with setpoint value specification
- Display of room and setpoint temperature, time and date in conjunction with KNX Timer switch.
- Indication of outside temperature (only with external sensor)
- Integrated bus coupling unit
- Second operation level for display and temperature settings
- Various icons are available in order to understand the indicated values

Technical data

KNX supply:	DC 21 ... 32 V SELV
Power consumption KNX:	max. 240 mA
Connection, KNX:	terminal
Protection class:	III
Ambient temperature:	-5 ... +45 °C
Storage/transport temperature:	-25 ... +75 °C

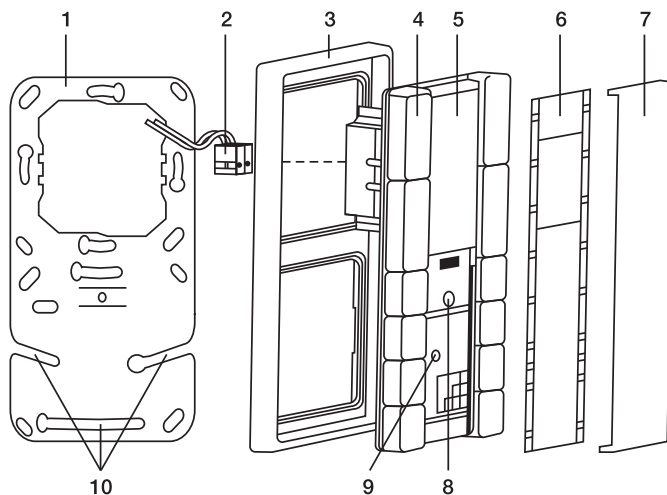
Connection and mounting of RCD 20xx:**Mounting:**

- a. Metal supporting frame (1) to be mounted on one or two vertically arranged wall boxes.
When using only one box, the lower part has to be screwed via the fixing holes (10).
 - b. Attach the frame (3) to the RCD.
 - c. Connect the bus terminal (2) at the back side.
 - d. Attach the RCD (4) and frame (3) on the metal supporting frame (1).
 - e. Screw on the fixing screw (8).
 - f. Remove the protection foil (5) from the display.
 - g. Put on the transparent cover (7) with the inscription foil (6) to the RCD.
- The programming mode is activated by pushing the programming button (9).

Note: Do not mount the device next to heat sources due to the influence of the integrated temperature sensor.





KNX Push-button BCU

The push-button BCU is available for all design ranges and for industrial solutions in WG 800 range (IP44).

The BCU is also available as a 1-gang and 2-gang version with rockers in neutral or switch position. The parameter are of course set with the ETS software.



Ref.-no.

Depending on the version of the push-button BCU – 1-gang rocker or 2-gang rocker – centre plates are used with and without indication lights. The “upper” or “lower” rockers can be controlled with the push-button with “neutral position”, while only the “lower” rocker can be pressed with the push-button with “switch position”.

The push-button BCU can only function with an application program i.e. the push-button BCU consists of the device (hardware) and the application program (software).

Flush-mounted

Push-button BCU, neutral position

Function: switching, dimming, shutter control

LED: always ON, always OFF, status indication

1-gang

2071.02 LED

Can operate up to two different groups (with switch function).

Status indication is possible with LED

Push-button BCU, switch position

Function: switching, dimming

LED: always ON, always OFF

1-gang

2071.01 LED

Can operate one group.

Status indication is possible with LED

Push-button BCU, neutral position

Function: switching, dimming, shutter control

LED: always ON, always OFF, status indication

2-gang

2072.02 LED

Can operate up to four different groups (with switch function).

Status indication is possible with LED

Push-button BCU, switch position

Function: switching, dimming, shutter control

LED: always ON, always OFF

2-gang

2072.01 LED

Can operate up to two different groups (with switch function).

Status indication is possible with LED

Technical data

Voltage:

21 ... 32 V DC

Power consumption:

max. 150 mW

Behaviour at bus voltage failure:

Object values will be set to "0". LEDs are switched off, no telegram is sent.

Behaviour at bus voltage recovery:

Object values remain "0". LEDs remain off, no telegram is sent.

Ambient temperature:

-5 ... +45 °C

The push-button BCU fits in every JUNG range like CD 500 / CD plus, LS 990 / LS plus, Stainless Steel, Aluminium, AS 500 / A 500 / A plus and SL 500.

The corresponding ref.-no. are shown in the main catalogue.

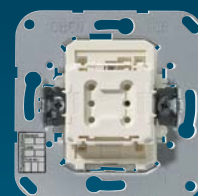
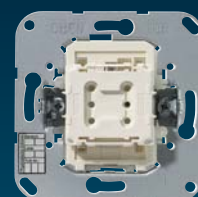

Programming push-button

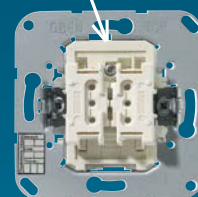

2072.02 LED

Programming push-button

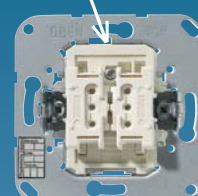

2072.01 LED



	Ref.-no.
Surface-mounted WG 800 Push-button BCU, neutral position Function: switching, dimming, shutter control LED: always ON, always OFF, status indication 1-gang Can operate up to two different groups (with switch function). Status indication is possible with LED	8071.02 LED W
Push-button BCU, switch position Function: switching, dimming LED: always ON, always OFF 1-gang Can operate one group. Status indication is possible with LED	8071.01 LED W
1-gang rocker with lens for 1-gang push-button BCU neutral position ref.-no.: 8071.02 LED W switch position ref.-no.: 8071.01 LED W	800 NT
1-gang rocker with lens and symbols for 1-gang push-button BCU neutral position ref.-no.: 8071.02 LED W	800 P
Rocker with inscription field for 1-gang push-button BCU neutral position ref.-no.: 8071.02 LED W switch position ref.-no.: 8071.01 LED W with inscription field 22 x 48 mm	800 NA
1-gang rocker with large lens for 1-gang push-button BCU neutral position ref.-no.: 8071.02 LED W switch position ref.-no.: 8071.01 LED W with red symbol	800 KO
Lenses printed with symbols for switches and push-buttons with indicator light	
anthracite symbol light	33 AN L
anthracite symbol bell	33 AN K
anthracite symbol door	33 AN T
anthracite neutral	33 AN N
green neutral	33 GN
transparent neutral	33 KLAR
red neutral	33 NR

	Ref.-no.
<p>Push-button BCU, neutral position Function: switching, dimming, shutter control LED: always ON, always OFF, status indication 2-gang</p>	8072.02 LED W
<p>Can operate up to four different groups (with switch function). Status indication is possible with LED</p>	
<p>Push-button BCU, switch position Function: switching, dimming, shutter control LED: always ON, always OFF 2-gang</p>	8072.01 LED W
<p>Can operate up to two different groups (with switch function). Status indication is possible with LED</p>	
<p>2-gang rocker with lens for 2-gang push-button BCU neutral position ref.-no.: 8072.02 LED W switch position ref.-no.: 8072.01 LED W</p>	805 NT
<p>2-gang rocker with lens and symbols for 2-gang push-button BCU switch position ref.-no.: 8072.01 LED W</p>	805 P
<p>2-gang rocker with lens and symbols for 2-gang push-button BCU neutral position ref.-no.: 8072.02 LED W</p>	805 MP

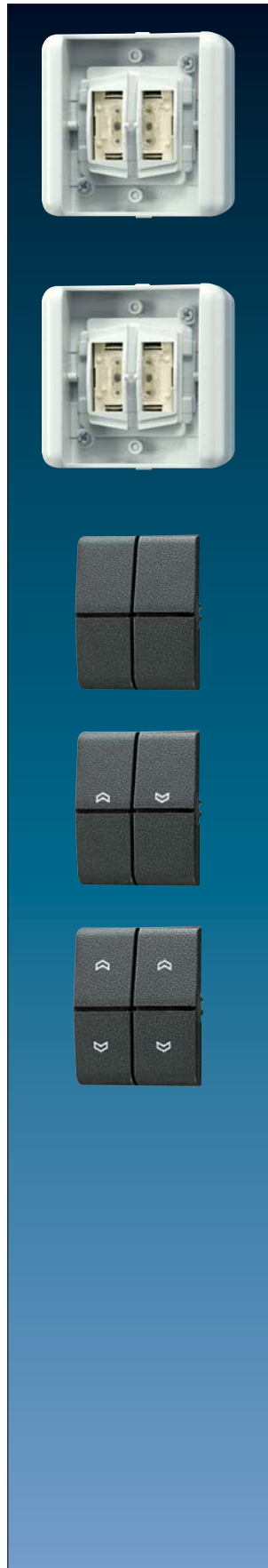

Sensor technology

The JUNG product portfolio offers a variety of solutions for the control of KNX room functions in an elegant design. Whether you wish to control the lighting, temperature or blinds or implement multirooming, multimedia integration or an alarm system – with the KNX sensors, the highest level of user comfort, security and energy efficiency is guaranteed.



Automatic switches for movement-dependent, energy-saving lighting control in staircases, corridors and hallways.



It is possible to set your own ideal temperature by programming the KNX temperature controller.



The presence detector controls the interior lighting and temperature via presence detection.

JUNG



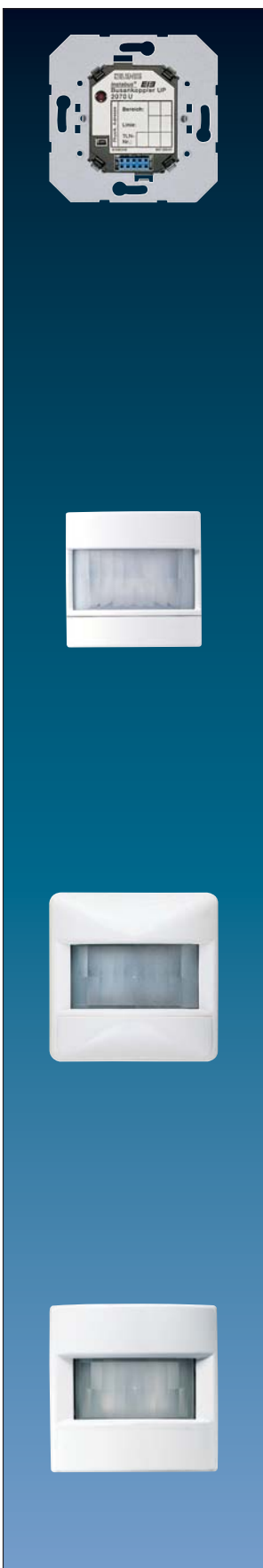

Ref.-no.

Bus coupling unit

screw fixing only, without claws
 ETS product family: System components
 Product type: Bus coupling unit

2070 U

**PIR automatic switch 180°, standard
 for bus coupling unit ref.-no.: 2070 U**

ETS product family: Physical sensors
 Product type: Movement
 sensitivity approx. 20 – 100 %, adjustable with potentiometer

**for AS 500, A 500, A plus and A creation
 for 1.1 m mounting height**

ivory	A 3180
white	A 3180 WW
aluminium	A 3180 AL
black	A 3180 SW

for 2.2 m mounting height

ivory	A 3280
white	A 3280 WW
aluminium	A 3280 AL
black	A 3280 SW

**for CD 500 and CD plus
 for 1.1 m mounting height**

ivory	3180
white	CD 3180 WW
grey	CD 3180 GR
light grey	CD 3180 LG
black	CD 3180 SW

for 2.2 m mounting height

ivory	3280
white	CD 3280 WW
grey	CD 3280 GR
light grey	CD 3280 LG
black	CD 3280 SW

**for the LS design ranges
 for 1.1 m mounting height**

ivory	LS 3180
white	LS 3180 WW
light grey	LS 3180 LG
black	LS 3180 SW

Metal versions

aluminium (lacquered)	AL 3180
stainless steel (lacquered)	ES 3180
anthracite (lacquered)	AL 3180 AN
chrome	GCR 3180

Ref.-no.

**PIR automatic switch 180°, standard
for bus coupling unit ref.-no.: 2070 U**

ETS product family: Physical sensors

Product type: Movement

sensitivity approx. 20 – 100 %, adjustable with potentiometer

**for the LS design ranges
for 2.2 m mounting height**

ivory	LS 3280
white	LS 3280 WW
light grey	LS 3280 LG
black	LS 3280 SW
Metal versions	
aluminium (lacquered)	AL 3280
stainless steel (lacquered)	ES 3280
anthracite (lacquered)	AL 3280 AN
chrome	GCR 3280

The KNX standard automatic switch is plugged onto a flush-mounted bus coupling unit. It reacts to changes in temperature like people moving into the detection area. This causes switching commands to devices such as binary outputs to switch groups of lights. The automatic switch has a detection angle of 180°. This angle can be restricted to 90° with a slip-on screen.

Two different standard automatic switches are available:

- Device for 1.1 m mounting height (ref-no: ..3180..)
- Device for 2.2 m mounting height (ref-no: ..3280..)

The standard automatic switch has three applications:

- PIR single unit for stand-alone installation
- PIR master unit for master/extension installation (e.g. long corridor)
- PIR extension unit for master/extension installation





Ref.-no.

**PIR automatic switch 180°, universal
for bus coupling unit ref.-no.: 2070 U**

ETS product family: Physical sensors

Product type: Movement

A slide switch (ON/AUTO/OFF) is integrated.

The device has three potentiometers for time, brightness and sensitivity adjustable from the front side (time, brightness ± 50% adjustable, basic settings via ETS).

sensitivity approx. 20 – 100 %

**for AS 500, A 500, A plus and A creation
for 1.1 m mounting height**

ivory	A 3180-1 A
white	A 3180-1 A WW
aluminium	A 3180-1 A AL
black	A 3180-1 A SW

for 2.2 m mounting height

ivory	A 3280-1 A
white	A 3280-1 A WW
aluminium	A 3280-1 A AL
black	A 3280-1 A SW

**for CD 500 and CD plus
for 1.1 m mounting height**

ivory	3180-1 A
white	CD 3180-1 A WW
grey	CD 3180-1 A GR
light grey	CD 3180-1 A LG
black	CD 3180-1 A SW

for 2.2 m mounting height

ivory	3280-1 A
white	CD 3280-1 A WW
grey	CD 3280-1 A GR
light grey	CD 3280-1 A LG
black	CD 3280-1 A SW

**for the LS design ranges
for 1.1 m mounting height**

ivory	LS 3180-1 A
white	LS 3180-1 A WW
light grey	LS 3180-1 A LG
black	LS 3180-1 A SW

Metal versions

aluminium (lacquered)	AL 3180-1 A
stainless steel (lacquered)	ES 3180-1 A
anthracite (lacquered)	AL 3180-1 A AN
chrome	GCR 3180-1 A
gold-coloured	GO 3180-1 A

for 2.2 m mounting height

ivory	LS 3280-1 A
white	LS 3280-1 A WW
light grey	LS 3280-1 A LG
black	LS 3280-1 A SW

Metal versions

aluminium (lacquered)	AL 3280-1 A
stainless steel (lacquered)	ES 3280-1 A
anthracite (lacquered)	AL 3280-1 A AN
chrome	GCR 3280-1 A

The KNX universal automatic switch is plugged onto a flush-mounted bus coupling unit. It reacts to changes in temperature as people are moving into the detection area. This causes switching commands or value transmission to devices such as binary outputs to switch light or dimming actuators. It can also be used to release light scenes in combination with a light scene control unit.

The universal automatic switch is equipped with three potentiometers for time, brightness and sensitivity adjustable from the front side. A slide switch (ON/AUTO/OFF) is also integrated. It has two major operation modes. One mode for lighting purposes as explained and one mode for monitoring purposes used for simple alarm detection or in combination with the Central Alarm Unit EAM 4000. By activating a specific object the device can be toggled between the two modes. The universal automatic switch has a detection angle of 180°. This angle can be restricted to 90° with a slip-on screen.

Two different universal automatic switches are available:

- Device for 1.1 m mounting height (ref-no: ..3180-1 A..)
- Device for 2.2 m mounting height (ref-no: ..3280-1 A..)

The universal automatic switch has three applications:

- PIR single unit for stand-alone installation
- PIR master unit for master/extension installation (e.g. long corridor)
- PIR extension unit for master/extension installation

Detected area with mounting height of 1.1 m

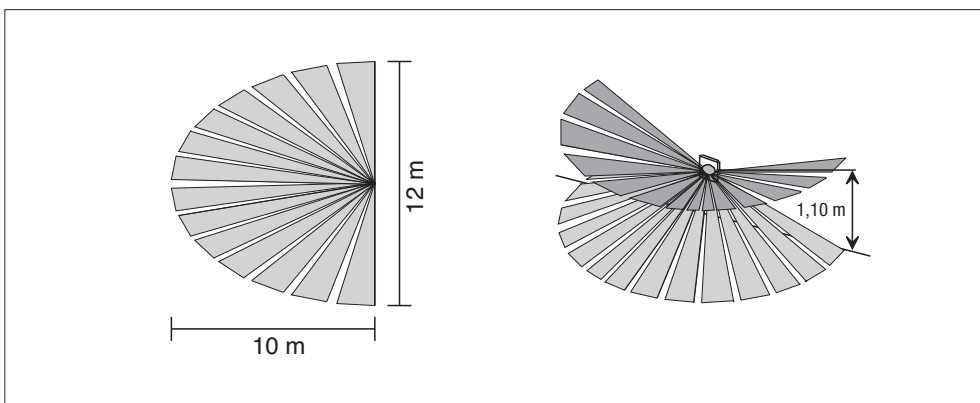

Detected area with mounting height of 2.2 m

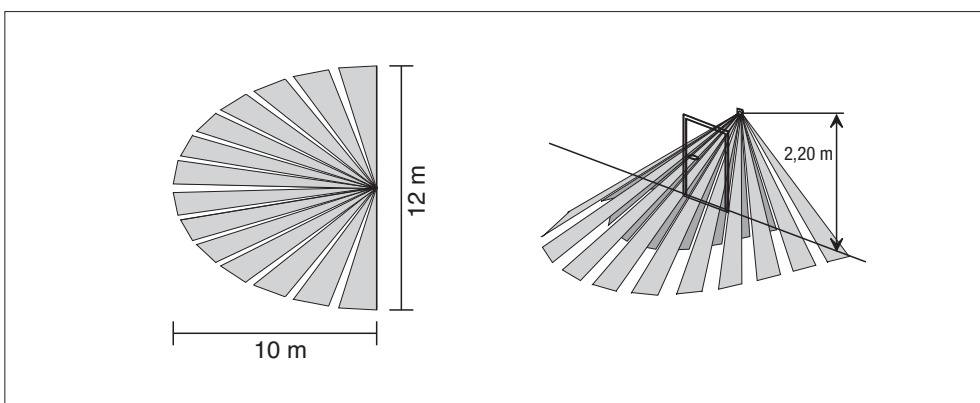



Technical data

Voltage:	21 ... 32 V DC via flush-mounted BCU
Power consumption:	max. 150 mW
Behaviour at voltage failure:	no telegrams are sent
Behaviour at voltage recovery:	object values = 0, out of function for approx. 80 s
Detection angle:	approx. 180°
Ambient temperature:	-5 ... +45 °C
Number of segments/detection levels:	18 / 2

Cap lens for 1.10 m installation height

Front rated detection range:	10 m
Lateral rated detection range:	2 x 6 m
Mounting height:	1.10 m

Cap lens for 2.20 m installation height

Front rated detection range:	12 m
Lateral rated detection range:	2 x 6 m
Mounting height:	2.20 m

Product characteristics (Standard and Universal)

After detection of movement the device will send an ON-telegram. At the end of detection and after the default min. delay time of 10 sec an OFF-telegram will be released. The evaluation of detection and the delay time can be changed by parameters.

To avoid malfunctions after releasing the OFF-telegram (e.g. wrong detection by cooling down of a switched off halogen lamp), the device is locked-out for about 3 sec. In between these 3 sec no detection can be evaluated. The lock-out time can be adjusted by parameters.

The automatic switch only evaluates detections when the brightness value is under the adjusted lighting level which has a default value of 15 lux. It is possible to set the device brightness independently.

Additionally, a cyclical transmission during the detection can be activated. The disable object deactivates the automatic switch. It can not detect any movement as long as the disable object is active. The telegram at start and end of blocking can be adjusted by parameters.

Description of Master / extension unit installation

It is possible to have one or several extension units (satellites) for one master unit in order to enlarge the detection area.

In addition to the single unit application a movement object is available. The object is used for the communication between the master and the extension unit. Every extension unit receives the real switch telegram of the master unit by the object switch (status). The extension unit receives the real switch status of the master. The automatic switch can be combined with several standard automatic switches or with the universal presence detector.

Note: In the project design you have to take care that the switch objects of the devices (master/extensions) and the movement objects are connected.
After commissioning or after bus voltage recovery the device is blocked for about 80 sec. During that time no movements can be detected.

Additional functions of the universal automatic switch

Walking test:

The walking test is used to adjust the sensitivity of the automatic switch when the device is put into operation. It is no operation mode and should be inactive after starting the device.

The walking test function will be activated after removing and putting on again the cover or after a bus reset, if:

1. the ETS parameter "walking test activated" Yes/No is fixed to Yes and
2. the potentiometer for the level of dimmed lighting is turned to the max. and
3. the potentiometer for additional sending delay is turned to "-50 %" (zero position).

The walking test function will be deactivated after removing and putting on again the cover or after a bus reset, if:

1. the ETS parameter "walking test activated" Yes/No is fixed to No or
2. the potentiometer for the level of dimmed lighting is not turned to the max. or
3. the potentiometer for additional sending delay is not turned to "-50 %" (zero position).

Removal recognition – event signal after removal:

When the cover is removed from the BCU a report in form of an ON or OFF telegram can be released via the alarm object. Alternatively, this function can be disabled by ETS parameter "alarm function disabled".

Signal operation:

In the signal operation mode, the automatic switch reacts less sensitive to detected movements.

The criterion for releasing an event signal telegram is the number X of movements within a fixed time period (monitoring time).

In this operation mode a configuration as master and extension input is not possible.

Every device works separately and sends, after detection and evaluation of the movement, a telegram via the event signal object to e.g. a display, signal panel, visualisation etc.

The signal operation mode can be both, just single mode as well as mixed with lighting modes. In the mixed operation mode it can be switched between the modes via the operation mode object.



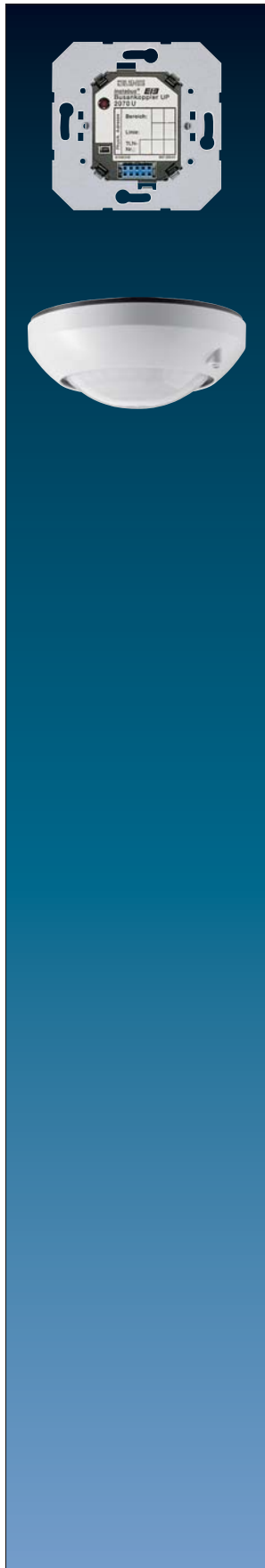

Ref.-no.

Bus coupling unit

screw fixing only, without claws
 ETS product family: System components
 Product type: Bus coupling unit

2070 U
**Presence detector 360°
 for bus coupling unit ref.-no.: 2070 U**

ETS product family: Physical sensors
 Product type: Movement

Standard

3360

Universal

3360-1

The presence detector is equipped with a PIR and responds to thermal movements triggered by persons, animals or objects.

The standard presence detector can be operated in two different modes:

- indoor presence: presences detector function mode
- indoor movement detection, ceiling mounted detection mode

In both modes the device offers two output channels which can be parameterized separately.

Changing between the operation modes requires re-programming via ETS. The standard presence detector can only be used as a stand-alone device and should be exclusively mounted to the room ceiling in order to monitor the area below.

The purpose of a presence detector is to switch ON e.g. the light when a movement is detected. Depending of a preset brightness threshold, it switches OFF again if there is sufficient brightness without artificial light or in case nobody is present any longer.

The universal presence detector is used for the detection of presence (presence detector mode), for the detection of movements (ceiling-mounted detector mode) and for the supervision of signalling telegrams (signalling mode) in rooms.

In these three modes of operation, the device offers 4 output channels, two of which can be active in one mode of operation respectively and which can be independently parameterized. The modes of operation, presence detector, ceiling-mounted detector and signalling mode can be defined when the device is parameterized with the ETS software.

The universal presence detector can be used as a stand-alone unit, as master (main unit) or slave unit (extension unit) and should be mounted exclusively under the room ceiling from where it monitors the area below. Besides universal presence detectors, standard or universal automatic switches can be used as extensions as well.

Ceiling-mounted detector mode

In the ceiling-mounted detector mode, the device detects movements and will transmit the message parameterized at the beginning of detection if the brightness value measured is below the twilight value set. If the message was transmitted at the beginning of detection, the device will work independently of the ambient brightness.

If no more movements are detected, the device will transmit the parameterized message at the end of detection after the preset overall transmit delay (standard transmit delay (10 s) + additional transmit delay) has elapsed.

Presence detector mode

In the presence detector mode, the device detects the presence of a person and will transmit the message parameterized at the beginning of detection if the brightness value measured is below the twilight value set.

If no more presence is detected now and the preset overall transmit delay (standard transmit delay (10 s) + additional transmit delay) has elapsed, or if the preset twilight value has been exceeded, for example, by double the value for at least 10 minutes (depending on the software), the presence detector will transmit the parameterized message at the end of detection.

Ref.-no.

Alarm function

The detector is provided with an alarm function which is activated when the device is removed from the bus coupler.

Teach-in function

The teach-in function allows a direct local, object-controlled adaptation of the twilight value (switch-on threshold) to the ambient conditions.

For this purpose, a separate teach-in object is available for each output.

Signalling mode (only Universal)

In this mode with a signalling function, the device detects movement pulses independent of brightness and counts them with a pulse counter. If – within a fixed time-span (standard value: 10 seconds) – at least the fixed number of pulses (standard value: 4) have passed the counting gate, the programmed telegram representing the beginning of detection will be transmitted. When no movement pulses are detected anymore, the presence detector transmits the programmed telegram representing the end of detection after the standard transmit delay of 10 seconds has elapsed. In the signalling mode, the presence detector 'Universal' is always operated as an individual unit.

Technical data

Voltage:	21 ... 32 V DC via flush-mounted BCU
Power consumption:	typical 150 mW
Detection angle:	360°
Nominal range at desk height:	Ø approx. 5 m
Nominal range at floor level:	Ø approx. 8 m
Installation height for nominal range:	approx. 2.5 m
	The nominal field of detection varies with different heights of installation.
Number of segments/detection levels:	80 / 6
Behaviour at bus voltage failure:	no response
	Active movements detected or running delays will be disregarded and not continued after bus voltage recovery.
Behaviour at bus voltage recovery:	depending on the used mode
	thermal movement detection immunity time: approx. 40 s
Ambient temperature:	-5 ... +45 °C
Storage/transport temperature:	-25 ... +70 °C

Notes:

- The device shall not be mounted in the close vicinity of heat sources, e.g. lamps. Also the vicinity of fans, radiators, or ventilating ducts can cause unwanted triggering.
- Install the internal brightness sensor at the side opposite to the window to avoid unwanted influences of scattered light.

Surface-mounted housing

to fix BCU for ceiling installation (surface-mounted) of presence detector

white

PM-KAPPE

Dimensions: diameter 103 mm, height: 45 mm



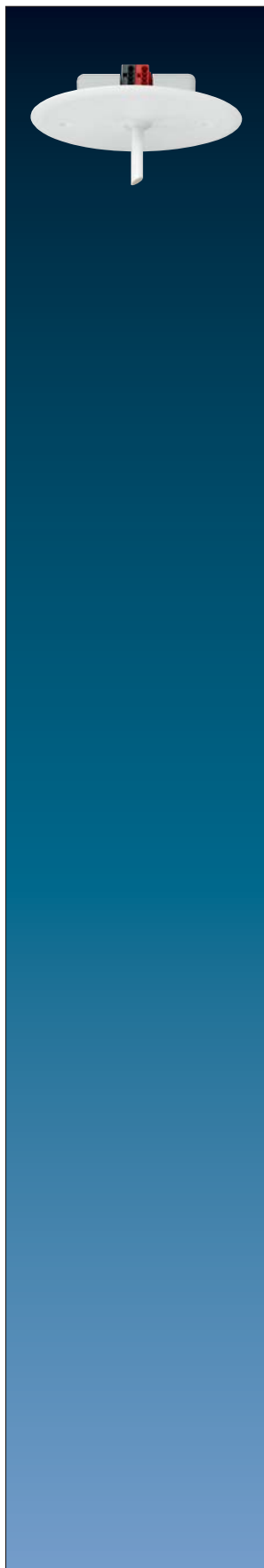

Ref.-no.

Flush-mounted brightness controller**2095 LUX****Intended use**

- Measurement and control of lighting in interior areas
- Ceiling installation
- Installation in wall box according to DIN 49073

Function

The brightness controller is used for metering and controlling workspace and room lighting. At the user's direction, the control can be selected as a switching On/Off control for controlling switch actuators or as a continuous constant light level control for controlling dimming actuators or switch/dimming actuators. The controller has an integrated bus coupling unit with bus connection via a bus terminal. The device is powered from the bus voltage.

The controller is delivered with two white-painted optical fibre rods (one rod with a plane light-sensitive surface and one rod with an oblique (30°) light-sensitive surface). One of these is plugged in by the user. Normally, the optical fibre rod with the plane light-sensitive surface is to be used. If necessary, the direction of the light-collection cone can be shifted by using the optical fibre rod with the oblique light-sensitive surface.

The brightness sensor and the red blinking commissioning LED are under the optical fibre rod.

Technical data

Ambient temperature:	-5 ... +45 °C
Storage/transport temperature:	-25 ... +70 °C
Relative humidity:	max. 93 % r. h., no condensation
Protection class:	III
Measuring range:	0 ... 2000 lx
Dimensions (L x W x H, without lid):	50 x 35 x 15 mm
Rated voltage KNX:	DC 21 ... 32 V SELV
Current consumption KNX:	15 mA
Connection, KNX:	KNX bus connection block

Ref.-no.

Brightness sensor

Rail mounting device, 2 rail units
control unit incl. light sensor

2160 REG

with integrated BCU

This 3 barrier brightness sensor controls switching and dimming actuators depending on the ambient brightness.

The level of brightness is recorded by a light sensor which is fitted externally and connected via a cable with the brightness sensor.

The device is very suitable for applications where a comfortable brightness-dependent lighting control has to be implemented.

Up to four different brightness areas can be surveyed with the device.

The device offers two applications:

- brightness sensor with 3 barriers
- brightness sensor with 4 scenes

Brightness sensor with 3 barriers

With this application the brightness sensor takes over the function of a 3-barrier limit value switch with a range of adjustment from 1 to 10 000 Lux. Each limit value can be adjusted separately.

The transmission behaviour of each channel can be parameterized when it is below or above a barrier. Via a 1 Byte object any combination of channels can be deactivated or activated temporarily.

Brightness sensor with 4 scenes

With this application the device takes over the function of a brightness controlled scene component with a range of adjustment from 100 to 20 000 Lux. Four brightness areas can be defined by three different switching levels.

Thereby a light scene, consisting of three switching and a value object, is assigned to each brightness area.

If the measured brightness value for an adjustable delay time is in an area, the parameterized switching and value messages are transmitted on the bus. Additionally, each scene object can be force-controlled over a so-called blocking object. If a value is transmitted to this object, objects 0 to 3 send their actual values. The behaviour of blocking can be parameterized.

Technical data

Operating voltage:	KNX bus supply voltage
Inherent consumption:	< 10 mA
Setting range:	1 ... 20000 lx
Switch delay:	8 s ... 240 s
Permissible ambient temperature:	-5 ... +45 °C
External sensor (IP 54):	
Cross-sectional area:	2 x 0.75 mm ²
Cable length:	max. 100 m

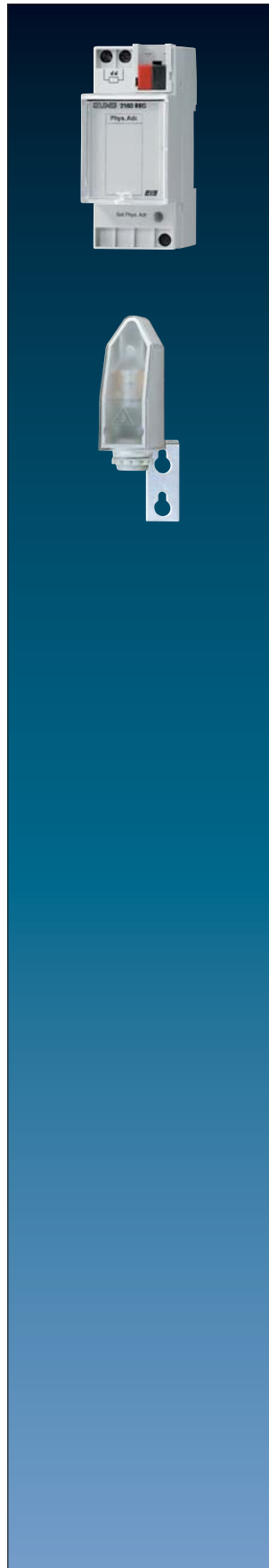

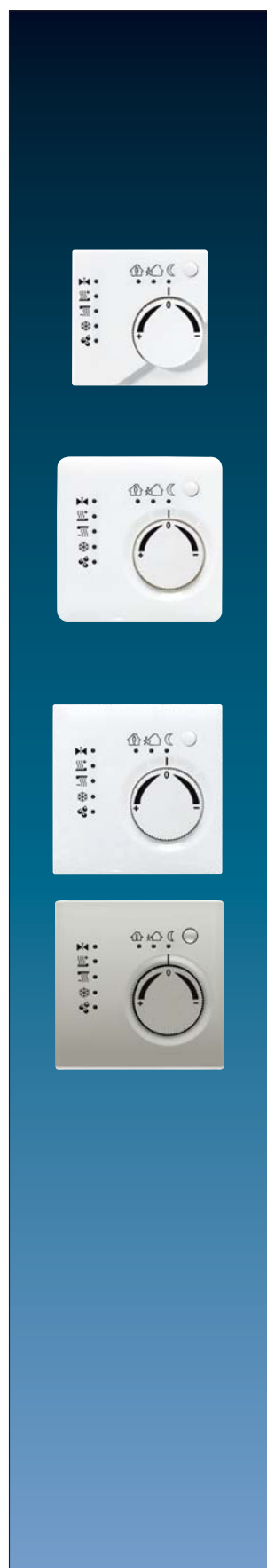

Ref.-no.

**Room temperature controller
with integrated BCU
with rotary knob for set point adjustment**

Only with the ETS 3.0d version or later versions the full functionality will be available.

ETS product family: Heating, A/C, ventilation

Product type: Regulator

for AS 500, A 500, A plus and A creation

ivory	A 2178
white	A 2178 WW
aluminium	A 2178 AL
black	A 2178 SW

for CD 500 and CD plus

ivory	2178
white	CD 2178 WW
grey	CD 2178 GR
light grey	CD 2178 LG
black	CD 2178 SW

for the LS design ranges

ivory	LS 2178
white	LS 2178 WW
light grey	LS 2178 LG
black	LS 2178 SW

Metal versions

aluminium	AL 2178
stainless steel	ES 2178
anthracite (aluminium lacquered)	AL 2178 AN
chrome	GCR 2178

The temperature controller with integrated BCU is used for a single room temperature control. Dependent on the operation mode and the actual temperature it controls a heating or cooling system by the KNX.

It is possible to choose between different control principles as a continuous PI control, switching PI control (pulse width modulation) and a switching two-step control.

Intended use

- Single-room temperature control in KNX installations
- Installation in appliance box according to DIN 49073

Product characteristics

- Measurement of room temperature and comparison with setpoint temperature
- Setpoint specification by selection of the operating mode
- Operating modes: Comfort, Standby, Night operation, Frost/heat protection
- Heating and cooling mode
- Heating and cooling with basic and additional step
- Setpoint adjustment
- Presence push-button and status LEDs

Ref.-no.

**Room temperature controller
with integrated BCU
with integrated push-button interface 4-gang
with rotary knob for set point adjustment**

Only with the ETS 3.0d version or later versions the full functionality will be available.

ETS product family: Heating, A/C, ventilation

Product type: Regulator

for AS 500, A 500, A plus and A creation

ivory	A 2178 TS
white	A 2178 TS WW
aluminium	A 2178 TS AL
black	A 2178 TS SW

for CD 500 and CD plus

ivory	2178 TS
white	CD 2178 TS WW
grey	CD 2178 TS GR
light grey	CD 2178 TS LG
black	CD 2178 TS SW

for the LS design ranges

ivory	LS 2178 TS
white	LS 2178 TS WW
light grey	LS 2178 TS LG
black	LS 2178 TS SW

Metal versions

aluminium	AL 2178 TS
stainless steel	ES 2178 TS
anthracite (aluminium lacquered)	AL 2178 TS AN
chrome	GCR 2178 TS

The temperature controller with integrated BCU is used for a single room temperature control. Dependent on the operation mode and the actual temperature it controls a heating or cooling system by the KNX.

It is possible to choose between different control principles as a continuous PI control, switching PI control (pulse width modulation) and a switching two-step control.

The actual room temperature can be measured either by the integrated temperature sensor or by an external one which is connected to channel 4 of the integrated push-button interface.

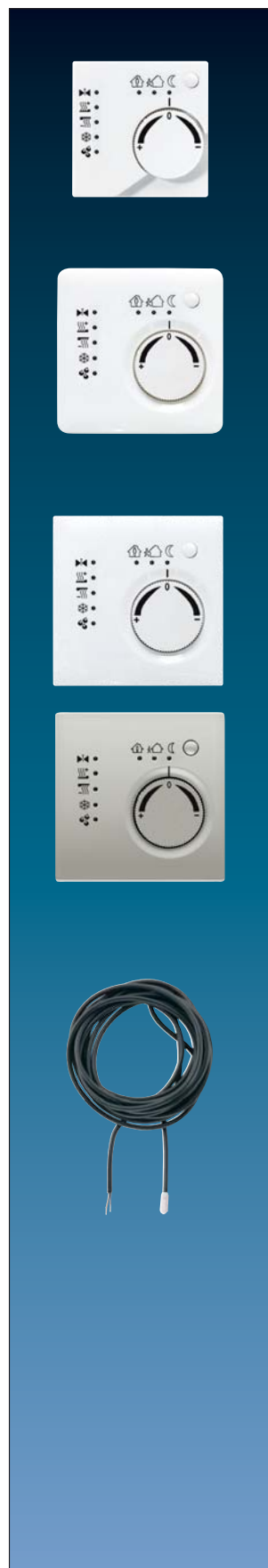

**Intended use**

- Single-room temperature control in KNX installations
- Integrated 4-gang binary input for universal use
- Installation in appliance box according to DIN 49073

Product characteristics

- Measurement of room temperature and comparison with setpoint temperature
- Setpoint specification by selection of the operating mode
- Operating modes: Comfort, Standby, Night operation, Frost/heat protection
- Heating and cooling mode
- Heating and cooling with basic and additional system
- Setpoint adjustment
- Presence push-button and status LEDs
- Push-button interface with four inputs or two outputs (0.8 mA) and two inputs, e.g. for window contacts, push-buttons, LEDs, etc.
- Function of the inputs: switching, dimming, shutter control, light scene extension, brightness or temperature value transmitter
- Option: External temperature sensor (accessory 133 k Ω NTC, ref.-no.: FF 7.8) connectable to input 4

Technical data

Rated voltage KNX:	DC 21 ... 32 V SELV
Current consumption KNX:	max. 10 mA
Connection, KNX:	terminal
Ambient temperature:	-5 ... +45 °C
Storage/transport temperature:	-25 ... +70 °C
Output current:	0.8 mA
Inputs and outputs	
Cable type:	J-Y(St)Y 2 x 2 x 0.6 mm ²
Cable length:	max. 5 m
Temperature sensor cable length:	max. 50 m

Use deep wall box for cables with 1.5 mm²

Optional accessory:**External sensor****FF 7.8**

(Spare part) for floor thermostat ref. no. FTR ... 231 ...
NTC sensor in plastic cap 7.8 mm \varnothing , with 4 m cable

Ref.-no.

Room autostat**with integrated BCU****with integrated push-button interface 4-gang****without rotary knob for set point adjustment**

without any operational elements

Only with the ETS 3.0d version or later versions the full functionality will be available.

ETS product family: Heating, A/C, ventilation

Product type: Regulator

for AS 500, A 500, A plus and A creation

ivory	A 2178 ORTS
white	A 2178 ORTS WW
aluminium	A 2178 ORTS AL
black	A 2178 ORTS SW

for CD 500 and CD plus

ivory	2178 ORTS
white	CD 2178 ORTS WW
grey	CD 2178 ORTS GR
light grey	CD 2178 ORTS LG
black	CD 2178 ORTS SW

for the LS design ranges

ivory	LS 2178 ORTS
white	LS 2178 ORTS WW
light grey	LS 2178 ORTS LG
black	LS 2178 ORTS SW

Metal versions

aluminium	AL 2178 ORTS
stainless steel	ES 2178 ORTS
anthracite (aluminium lacquered)	AL 2178 ORTS AN
chrome	GCR 2178 ORTS

The temperature controller is also available in a version without any operational element as rotary knob, presence push-button or LEDs.

This version is called autostat. The functions of the autostat are exactly the same, it is operated solely via bus telegrams. This version is recommended for e.g. for public buildings where you should avoid the manual operation of the sensor.

Intended use

- Single-room temperature control in KNX installations
- Integrated 4-gang binary input for universal use
- Installation in appliance box according to DIN 49073
- Recommended for installations in public buildings



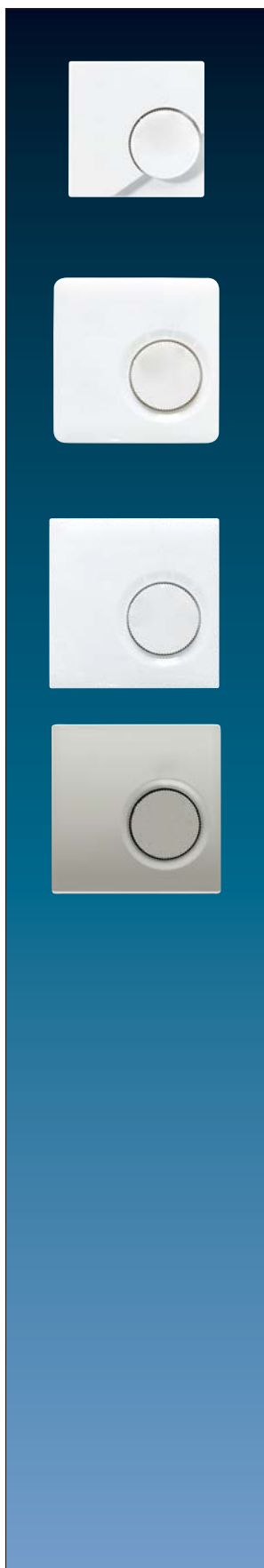

Product characteristics

- Measurement of room temperature and comparison with setpoint temperature
- Setpoint specification by selection of the operating mode
- Operating modes: Comfort, Standby, Night operation, Frost/heat protection
- Heating and cooling mode
- Heating and cooling with basic and additional system
- Operation solely via the bus
- Push-button interface with four inputs or two outputs (0.8 mA) and two inputs, e.g. for window contacts, push-buttons, LEDs, etc.
- Function of the inputs: switching, dimming, shutter control, light scene extension, brightness or temperature value transmitter.
- Option: External temperature sensor (accessory 133 k Ω NTC, ref.-no.: FF 7.8) connectable to input 4

Technical data

Rated voltage KNX:	DC 21 ... 32 V SELV
Current consumption KNX:	max. 7.5 mA
Connection, KNX:	terminal
Ambient temperature:	-5 ... +45 °C
Storage/transport temperature:	-25 ... +70 °C
Output current:	0.8 mA

Inputs and outputs

Cable type:	J-Y(St)Y 2 x 2 x 0.6 mm ²
Cable length:	max. 5 m
Temperature sensor cable length:	max. 50 m

Use deep wall box for cables with 1.5 mm²

Temperature controller – Key facts

General

- 5 operation modes: comfort, standby, night, frost/heat protection and disable controller.
- Changeover between modes by either a 1 byte KNX object (recommended) or by separate 1 bit objects.

Heating/cooling

- Operation modes: Heating, cooling, heating and cooling always with or without additional system
- PI controller (continuous or switched PWM) or 2step controller adjustable.
- Continuous (1 byte) or switched (1 bit) control output.
- Controller parameter for both principles adjustable.

Set points

- To each operation mode a temperature set point can be assigned.
- The set points for the additional system are derived by a defined step to the basic system.
- Set point adjustment possible either by rotary knob or ETS objects.

Functionality

- Automatic or object dependent changeover between heating and cooling.
- The operation of the controller can be disabled by an object.
- Complete (1 byte) or partial (1 bit) status information can be transmitted onto the bus.

Room temperature measurement

- Temperature measurement either by internal or external sensor.
- Evaluation of external temperature input to the internal value adjustable.
- The actual and set point temperature can be transmitted to be bus (also cyclical) after an adjustable deviation.
- Temperature alarm with upper and lower limit value possible via two separate objects.

Control value output

- Separate or common control value output via one or two objects (with heating and cooling mode).
- Control value output can be normal or inverted.
- Automatic sending of the control value output and the cyclic time are adjustable.

For further details of the functions/objects and the corresponding description, please refer to the complete product documentation which is available on our webpage!

Ref.-no.

**CO₂ Multi-Sensor
with integrated BCU
with integrated push-button interface 2-gang**

Only with ETS 3.0d or later versions the full functionality will be available.

ETS product family: Physical sensor

Product type: Regulator

CO₂ ... 2178 ..

for AS 500, A 500, A plus and A creation: CO₂ A 2178 ..

for CD 500 and CD plus: CO₂ CD 2178 ..

for LS design ranges: CO₂ LS 2178 ..

Metal versions: CO₂ ES (AL) 2178 ..

The CO₂ Multi-Sensor combines CO₂ measurement with a humidity and temperature controller.

In addition, it offers a universal 2-gang binary input.

Depending on the operation mode it controls the ventilation or window opener to achieve the optimal climate in a closed room like a class room, conference room or offices.

Product characteristics:

- Limit value monitoring for CO₂ concentration and air humidity
- Dew point alarm for, for example, cooling blankets and conservatories, to avoid possible mould formation
- Two binary inputs for connection of potentialfree contacts e.g. buttons, switches, window contacts
- Logic gates for simple gating functions

Function CO₂ sensor:

- Max of 4 different adjustable threshold values
 - Adaptation to current elevation above NN
- After switch-on, the CO₂ sensor requires a warm-up period of up to 5 minutes, until normal operation is reached.

Function Room temperature controller:

- Measurement of room temperature and comparison with setpoint temperature
- Setpoint setting by selection of the operating mode
- Operating modes Comfort, Standby, Night operation, Frost/heat protection
- Heating and cooling mode with basic and additional step

Function of humidity sensor:

- Max of 2 adjustable threshold values
- The device contains a sensitive, integrated humidity/temperature sensor. Longer storage at a higher or lower temperature of humidity leads to inaccuracies of the humidity reading. This difference is rectified again after a few days in operation.

Function Binary inputs:

- Functions: dimming, shutter control, light scene extension unit, brightness of temperature value transmitter.
- Inputs lockable in operation

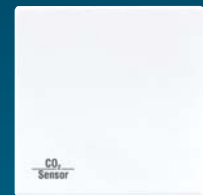
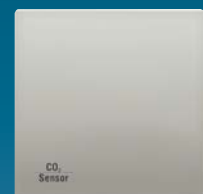
CO₂ A 2178 WWCO₂ CD 2178 WWCO₂ LS 2178 WWCO₂ ES 2178

Weather station

The KNX weather station captures data about wind speed, rainfall, twilight, temperature and brightness for automatic, weather-dependent shading control. The measured data is evaluated; if a programmed limit value is exceeded, the weather station automatically controls the shading in the corresponding location. In this way, the weather protection can be regulated as the current situation demands.

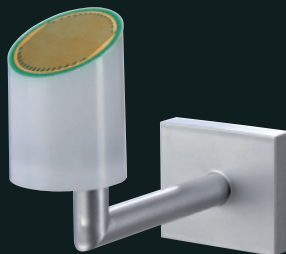

KNX weather station
"home"



Binary input,
4-gang

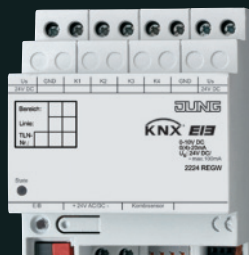

KNX weather station

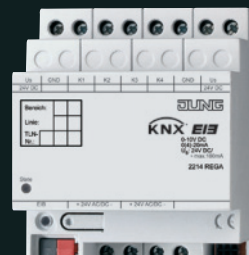

Analogue input,
4-gang

JUNG

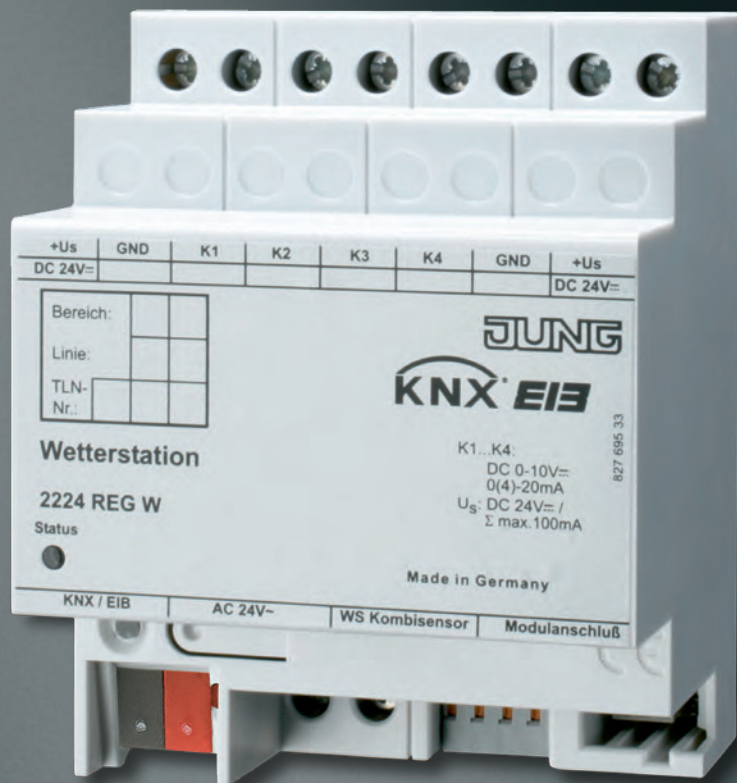



Ref.-no.

Timer switch with yearly program, 4-gang

Rail mounting device, 6 rail units

2154 REG**Produkt characteristics**

- BCU integrated into the unit
- 324 switching times for free assignments
- Permanent switching times by means of EEPROM
- Day/week/year program
- Random program
- Pulse program
- Switching times: ON or OFF delay
- 1 x function for all date-related switching times
- 10 priority programs consisting of 10 individual weekly programs per channel
- Automatic setting of public holidays without fixed date (i.e. Easter)
- Approx. 1.5 years battery reserve by means of exchangeable environmentally friendly lithium cell
- It can be programmed up to the year 2063 in advance
- Data transmission and data backup possible with memory card
- Three software applications:
 - a) scene with switching, value priority
 - b) switching, value, send time and date
 - c) switching, value, receive time and date
- Option: radio controlled, hence automatic synchronisation of summer/winter time by means of the DCF 77 signal
- Power supply for DCF receiver is integrated
- PC programming recommended by using the special software set OBELISK

Technical data

Operating voltage:	KNX bus supply voltage External supply: 230 V ± 10 %, only required in case of DCF77 antenna connection
Channels:	4
Switching times:	324 (free block formation)
Special program:	9 week programs
Inherent consumption:	< 10 mA
Shortest switching interval:	1 sec.
Switching accuracy:	1 sec.
Current consumption:	approx. 4 mA + BCU
Accuracy:	± 1 second/day at 20°C or radio time signal precision (with DCF77)
Power reserve:	Lithium cell approx. 1.5 years
Permissible ambient temperature:	-5 ... +45 °C
Max. distance to DCF receiver:	200 m

DCF receiver**2154 DCF**

Receiver module for the DCF77 radio signal
for timer switch, 4-gang, ref.-no.: 2154 REG

Technical data

Protection level:	IP 54
Wiring:	3 x 1.5 mm ² , max. 200 m
Reception area:	1000 km Frankfurt a.M.



	Ref.-no.
Software set for OBELISK memory card	2154 PC
<p>The programming set consists out of an OBELISK memory card for the data transmission between PC and time switch, a programming adapter and the software. The memory card can be used as data backup or for the transmission of the program from time switch to time switch.</p>	
OBELISK memory card	2154 EEPROM
<p>EEPROM for data transmission between PC and timer switch</p>	
Timer switch with weekly program, 2-gang	2152 REG
<p>Rail mounting device, 2 rail units</p> <p>BCU integrated into the unit.</p> <p>The 2 channel time switch can be used as a daily or as a weekly time switch. On each channel, switching, priority, brightness values or value messages (commands) can be transmitted at determined times. During a switching time, up to four telegrams (commands) can be transmitted via bus on one channel (e.g. "end of working day": switch off main lighting, drive shutter down, lower ambient temperature, lock external doors). The time switch offers: 36 captive switching times which are programmable by free block formation on one, several or all weekdays.</p> <p>In addition the device is already programmed ex factory with valid Middle-European switching for automatic summer/winter time switching and actual time.</p>	
Technical data	
Operating voltage:	KNX bus supply voltage
Channels:	2
Switching times:	36 (free block formation)
Special program:	holiday mode
Inherent consumption:	< 2 mA
Shortest switching interval:	1 minute
Current consumption:	approx. 2 mA + BCU
Accuracy:	≤ 1 second/day at 20 °C
Power reserve:	6 years
Permissible ambient temperature:	-5 ... +45 °C





Ref.-no.

Push-button interface, 2-gang

ETS product family: Input
Product type: Binary input

2076-2 T

- Can be used as binary input
- Can be used as switching output, e.g. for LEDs, max. 0.8 mA

Technical data

Inputs

Number:	2
Signal voltage:	5 V
Signal current:	> 1 mA
Wiring:	branching terminal, 5 pins
Length of input cable:	25 cm prefabricated, extendable to 5 m max

Outputs

Output voltage:	5 V with outputs open circuit (ballast resistor 3.9 kOhm)
Output current:	0.8 mA for red low-current LED (at approx. 1.4 V)
Dimensions (W x H x D):	28 x 43 x 16 mm

Push-button interface, 4-gang

ETS product family: Input
Product type: Binary input

2076-4 T

- Can be used as binary input
- Can be used as switching output, e.g. for LEDs, max. 0.8 mA

Technical data

Inputs

Number:	4
Signal voltage:	5 V
Signal current:	> 1 mA
Wiring:	branching terminal, 5 pins
Length of input cable:	25 cm prefabricated, extendable to 5 m max

Outputs

Output voltage:	5 V with outputs open circuit (ballast resistor 3.9 kOhm)
Output current:	0.8 mA for red low-current LED (at approx. 1.4 V)
Dimensions (W x H x D):	28 x 43 x 16 mm

The 2-channel (4-channel) push-button interface has 2 (4) independent channels which – depending on parameterization – can be used as inputs or alternatively as outputs. The push-button interface can therefore be used to poll its inputs for the switching state of up to 2 potential-free push-buttons/switches with a common reference potential and send the corresponding telegrams to the KNX. These may be telegrams for switching or dimming, shutter/blind control or value transmitter applications (dimming value transmitter, light-scene extension, temperature or brightness value transmitter). Moreover, 2 switching event counters or 1 pulse counter (only channel 1) are available. Channels 1 and 2 can be used alternatively as independent outputs for controlling up to two LEDs. To increase the output current (cf. Technical Data), the channels can also be connected in parallel if they are parameterised alike. The outputs are short-circuit-proof and protected against overloading and false polarity.

Connection 230 V signals or other external voltages to the inputs is not permitted.

Ref.-no.

Binary input, 4-gang

Rail mounting device, 2 rail units
 4 inputs AC 110 – 230 V ~ (different L conductors possible)
 with status indicator
 ETS product family: Input
 Product type: Binary input

2114 REG**Intended use**

- Polling of conventional switching or push-button contacts in KNX systems, for reporting of states, operation of loads, etc.
- Mounting on DIN rail according to EN 60715 in distribution boxes

Product characteristics

- Status LED for each input
- Detection of voltage levels and changes on the input
- Transmitting the input state to the bus
- Transmission behaviour freely adjustable
- Functions: switching, dimming, blinds up/down, brightness values, temperatures, recalling and saving light scenes
- Inputs 1 and 2: pulse and switch counter function
- Inputs can be disabled separately
- Different external conductors L1, L2, L3 can be connected
- Separate reference potentials N for each input

Technical data

Rated voltage KNX:	DC 21 ... 32 V SELV
Power consumption KNX:	max. 150 mW
Wiring, KNX:	terminal
Ambient temperature:	-5 ... +45 °C
Storage/transport temperature:	-25 ... +70 °C
Inputs	
Rated voltage:	AC 110 ... 230 V ~
Signal level "0" signal:	AC 0 ... 70 V ~
Signal level "1" signal:	AC 90 ... 253 V ~
Mains frequency:	50 / 60 Hz
Input current at rated voltage:	approx. 7 mA
Signal duration:	min. 200 ms
Signal delay	
rising edge:	approx. 2 ms
falling edge:	approx. 40 ms
Mounting width:	36 mm (2 rail units)
Power loss:	max. 1.7 W
Wiring:	screw terminals
single wire:	0.5 ... 4 mm ²
stranded without ferrule:	0.5 ... 4 mm ²
stranded with ferrule:	0.5 ... 2.5 mm ²
Cable length:	max. 100 m

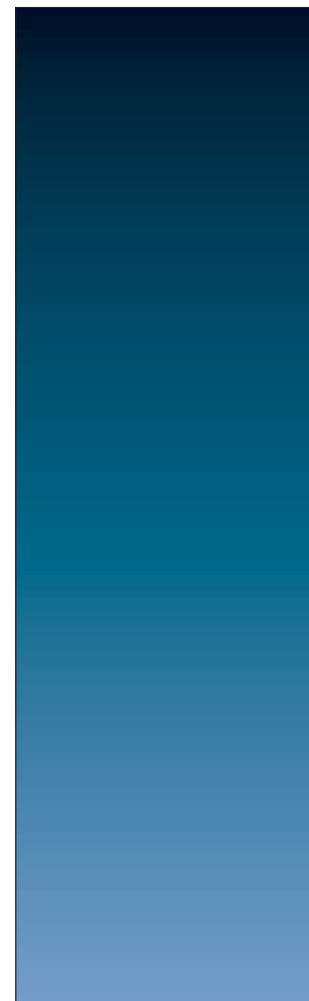
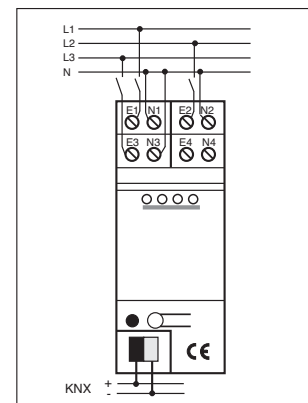

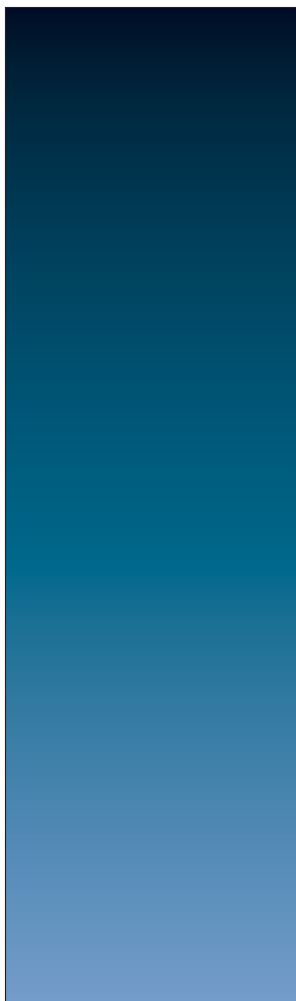
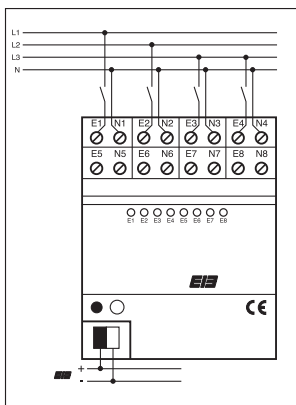

Ref.-no.

Binary input, 8-gang

Rail mounting device, 4 rail units
 8 inputs AC 110 – 230 V ~ (different L conductors possible)
 with status indicator
 ETS product family: Input
 Product type: Binary input

2118 REG

Intended use

- Polling of conventional switching or push-button contacts in KNX systems, for reporting of states, operation of loads, etc.
- Mounting on DIN rail according to EN 60715 in distribution boxes

Product characteristics

- Status LED for each input
- Detection of voltage levels and changes on the input
- Transmitting the input state to the bus
- Transmission behaviour freely adjustable
- Functions: switching, dimming, blinds up/down, brightness values, temperatures, recalling and saving light scenes
- Inputs 1 and 2: pulse and switch counter function
- Inputs can be disabled separately
- Different external conductors L1, L2, L3 can be connected
- Separate reference potentials N for each input

Technical data

Rated voltage KNX:	DC 21 ... 32 V SELV
Power consumption KNX:	max. 240 mW
Wiring, KNX:	terminal
Ambient temperature:	-5 ... +45 °C
Storage/transport temperature:	-25 ... +70 °C
Inputs	
Rated voltage:	AC 110 ... 230 V ~
Signal level "0" signal:	AC 0 ... 70 V ~
Signal level "1" signal:	AC 90 ... 253 V ~
Mains frequency:	50 / 60 Hz
Input current at rated voltage:	approx. 7 mA
Signal duration:	min. 200 ms
Signal delay	
rising edge:	approx. 2 ms
falling edge:	approx. 40 ms
Mounting width:	72 mm (4 rail units)
Power loss:	max. 3.4 W
Wiring:	screw terminals
single wire:	0.5 ... 4 mm ²
stranded without ferrule:	0.5 ... 4 mm ²
stranded with ferrule:	0.5 ... 2.5 mm ²
Cable length:	max. 100 m



Ref.-no.

Binary input, 6-gang

Rail mounting device, 2 rail units
 6 inputs 24 V AC/DC 50/60 Hz
 with status indicator
 ETS product family: Input
 Product type: Binary input

2126 REG

Intended use

- Polling of conventional switching or push-button contacts in KNX systems, for reporting of states, operation of loads, etc.
- Mounting on DIN rail according to EN 60715 in distribution boxes

Product characteristics

- Status LED for each input
- Detection of voltage levels and changes on the input
- Transmitting the input state to the bus
- Transmission behaviour freely adjustable
- Functions: switching, dimming, blinds up/down, brightness values, temperatures, recalling and saving light scenes
- Inputs 1 and 2: pulse and switch counter function
- Inputs can be disabled separately
- AC and DC voltages can be connected
- Separate reference potentials for inputs E1...E3 and E4...E6

Technical data

Rated voltage KNX:	DC 21 ... 32 V SELV
Power consumption KNX:	max. 225 mW
Wiring, KNX:	terminal
Ambient temperature:	-5 ... +45 °C
Storage/transport temperature:	-25 ... +70 °C
Inputs	
Rated voltage:	AC/DC 24 V
Signal level "0" signal:	AC/DC -42 ... +1.8 V
Signal level "1" signal:	AC/DC 8 ... 42 V
Input current at rated voltage:	approx. 4 mA
Signal duration:	min. 200 ms
Signal delay	
rising edge:	approx. 2 ms
falling edge:	approx. 40 ms
Mounting width:	36 mm (2 rail units)
Power loss:	max. 2 W
Wiring:	screw terminals
single wire:	0.2 ... 4 mm ²
stranded without ferrule:	0.34 ... 4 mm ²
stranded with ferrule:	0.14 ... 2.5 mm ²
Cable length:	max. 100 m

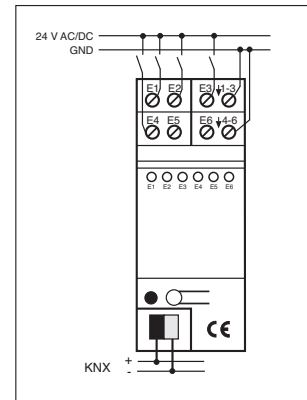

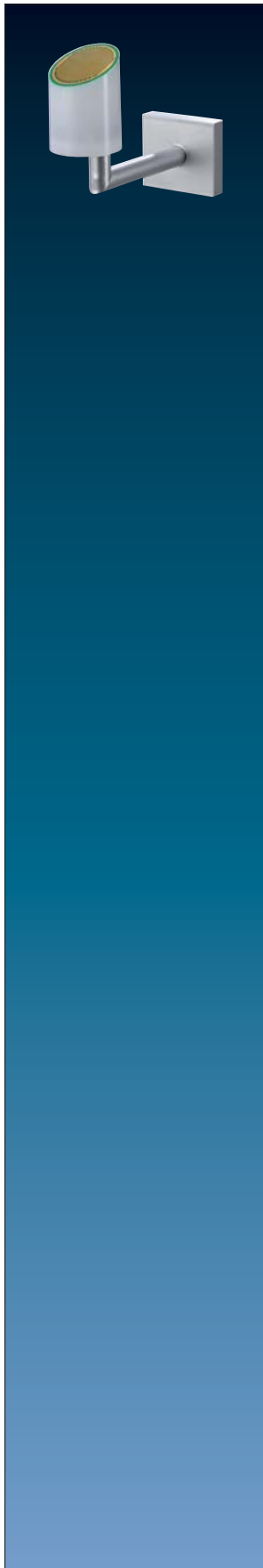

Ref.-no.

KNX weather station "home"**2224 WH**

The KNX weather station detects the meteorological data "Wind speed", "Rain", "Twilight", "Temperature" and the brightness in three directions. Its main area of application is the automatic, weather-dependent control of shading. It is specially designed for use in homes. To increase functional reliability, the weather station monitors itself in some important functions, and reports any corresponding errors to the bus automatically via indicator objects. It is intended for outdoor installation on a mast or on a wall. The bus coupling to the KNX is integrated. Evaluation of the data themselves, in particular the limiting value processing, is performed already in the weather station. A built-in heater protects against degradation of function from frost and moisture condensation down to -20 °C. The heating system further ensures that the sensor surface of the precipitation sensor will dry off quickly after rain, and also melts snow and ice. Power is supplied to the unit via the bus, except for the heating system and the power supply for the precipitation sensor. The weather station requires an external 24 V AC/DC power supply for the heating system, without the precipitation detection is not possible. Logic gates are available for cascading a number of weather stations and for linking the limiting values and the monitoring functions. Blocking elements make it possible to block individual functions at the installation location.

Intended use

- Measurement and evaluation of weather data: wind speed, precipitation, twilight, temperature and brightness
- Vertical mounting on the outside of buildings, preferably on roofs and at façades

Product characteristics

- Integrated KNX bus coupler
- Compact housing
- Low-maintenance device
- Measured-value acquisition and limit value monitoring

The power supply ref.-no.: WSSV 10 is necessary for precipitation detection.

Technical data

Rated voltage KNX:	DC 21 ... 32 V SELV
Power consumption KNX:	typical 450 mW
Wiring, KNX:	KNX bus connection block
External power supply	
Rated voltage:	AC/DC 24 V SELV
Power consumption:	typ. 7.5 W
Wiring:	connecting terminal yellow/white
Ambient temperature:	-20 ... +55 °C (free of ice and dirt)
Storing temperature:	-40 ... +70 °C
Protection level:	IP 44 (in position for use)
Protection class:	III
Dimensions (W x H x D):	approx. 88 x 170 x 204 mm (with assembly arm)
Weight:	approx. 240 g

Ref.-no.

Sensor signals

Temperature sensor	
Measuring range:	-20 ... +55 °C
Accuracy:	± 1 K (for wind speeds > 0.5 m/s)
Wind sensor	
Measuring range:	approx. 0 ... 40 m/s
Accuracy:	± 2 m/s
Precipitation sensor	
Measuring range:	precipitation yes / no
Sensitivity:	fine drizzle
Switch-off delay:	adjustable
Brightness sensors	
Direction:	east, south, west
Measuring range:	approx. 1 ... 110 klx
Spectral range:	approx. 700 ... 1050 nm
Accuracy:	10 % (upper end of measuring range)
Twilight sensor	
Direction:	south
Measuring range:	approx. 0 ... 674 lx
Spectral range:	approx. 700 ... 1050 nm
Accuracy:	10 % (upper end of measuring range)

Connection set**for weather station home ref.-no.: 2224 WH**

for pole mounting 50 – 120 mm Ø		MM 100
for edge mounting	white	MW 270 WW
for edge mounting	aluminium (lacquered)	MW 270 AL

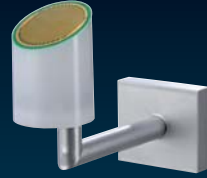

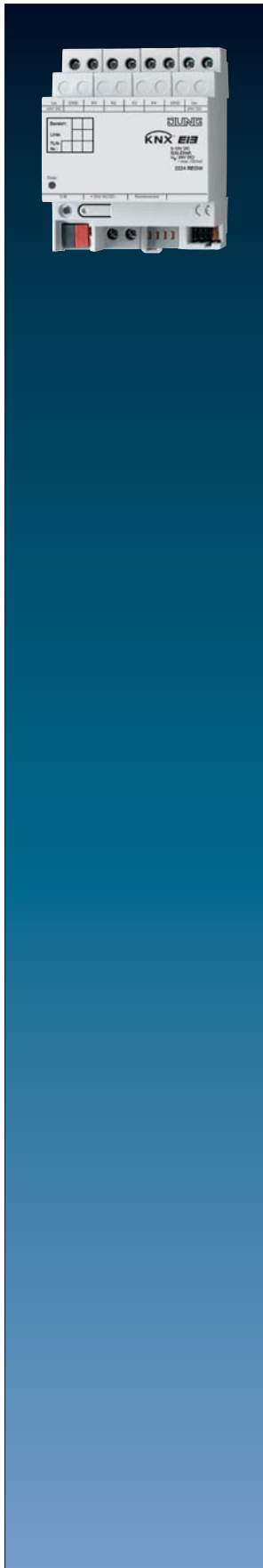

Ref.-no.

KNX weather station

Rail mounting device, 4 rail units

ETS product family: Input

Product type: Analogue input 4-gang

2224 REG W

The weather station serves to collect and forward weather data and events.

A digital combi sensor (to measure the wind intensity, brightness and twilight as well as rain; with or without DCF77 receiver), and up to four analogue measuring sensors can be connected to the weather station. In conjunction with the combination sensor a fully automated shading control depending on the sun position can be realised.

An optional analogue input extension module, allows the extension of the range of analogue measuring sensors to be connected by another four.

The weather station needs an operating voltage supply of 24 V AC, which can be provided by the power supply module (ref.-no. WSSV 10).

The following measuring sensors, for which preset parameters are available in the device software, can be connected to the analog inputs:

Brightness (WS 10 H), Twilight (WS 10 D), Temperature (WS 10 T), Wind (WS 10 W) and Rain (WS 10 R).

Alternatively, other measuring sensors supplying voltage or current signals (0 ... 1 V DC, 0 ... 10 V DC, 0 ... 20 mA DC, 4 ... 20 mA DC) can be used, too.

For sensors which supply 4 ... 20 mA signals, the device software parameters offer the option to select wire breakage or open-circuit monitoring.

The values measured are translated by the weather station into value telegrams (DPT 9.0xx, 2-byte or DPT 5.001, 1-byte type). Thus, other bus devices (e.g. visualization software, info display) can display such measured values, generate messages or control weather-dependent processes.

For each measured value, two adjustable limits are available. Once a measured value exceeds or falls below such limits, the weather station can issue corresponding messages. At the same time, such limits can be gated.

Technical data

Supply voltage:	AC 24 V ~ ± 15 %
Analogue inputs:	4
Format:	EIS 5 (2 Byte) or EIS 6 (1 Byte)
Ranges:	voltage 0 ... 1 V, 0 ... 10 V; current 0 ... 20 mA, 4 ... 20 mA; depending on parameterization
Limit values:	2 per channel
Supply output for sensor:	2 terminal pairs
Voltage:	DC 24 V ± 10 %
Total current:	max. 100 mA

Wiring diagram with extension module and combi sensor

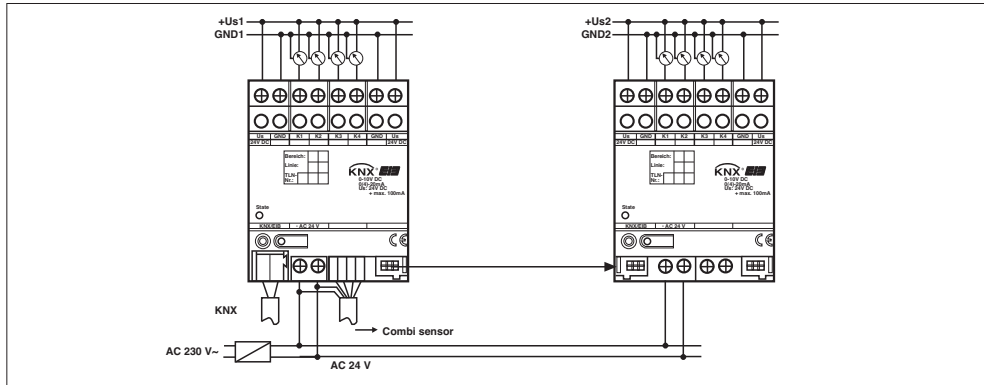

Remarks on the Hardware

Please observe the following basic rules when installing the weather station:

- Any sensors connected can be power-supplied via terminals +U_S and GND (refer to the wiring diagram). These terminals are provided in duplicate and are internally connected with each other. The total current consumption of all sensors power-supplied this way must not exceed 100 mA.
- In the event of a short-circuit between +U_S and GND, the voltage will be switched off. After the elimination of the fault, the voltage will reappear automatically.
- Sensors connected can also be power-supplied externally (SELV), e.g. if their current consumption exceeds 100 mA. In this case, such sensors must be connected between terminals K1 ... K4 and GND.
- The pillar terminal block for the connection of the combi sensor must be plugged on before the mains voltage is switched on and during operation to prevent the digital input from unintentional contact with live wiring. The device as well as any sensors or analog input extension modules connected can be destroyed thereby.
- The +U_S and GND terminals must not be connected with the corresponding inputs of a different device. The power supply of any sensors used through an analog input extension module connected is not permitted (hazard of destruction).

Please observe the following basic rules when installing the combi sensor:

- The sensor comes with a stainless steel bracket for installation on a tubular pole (35 ... 50 mm dia.). Depending on the wind intensity, very high forces can occur on such pole.
- If external lightning protection is provided the pole must not be higher than the lightning rod.
- The combi sensor should not be affected from any direction by obstacles or shadows. For this reason, a sufficient distance from walls or roof superstructures such as exhaust blowers should be kept.
- To enable the brightness and the twilight sensors to clearly detect the solar altitude align the combi sensor so that its precipitation window faces north.
- Removing or adding modules without adapting their configuration and subsequent downloading into the weather station is not allowed as this will result in system malfunctioning.
- After the first start, the weather station will run a module scan (status LED: "orange/ON"). Since a new device does not include any configuration by default the status LED will then change to "red/quickly blinking".
- The combi sensor connected indicates its readiness for operation by two short tones which will recur every 5 s.
- In this state, the combi sensor can be logged in and the antenna aligned (refer to the combi sensor operating instructions).
- A defective combi sensor can be replaced in operation by another one of the same type. In such case, the new combi sensor must be logged in once again and aligned. After logging in the new combi sensor, the weather station will reset after about 25 s. This will re-initialize all inputs and outputs of the weather station and of the modules connected and reset them to their original state.

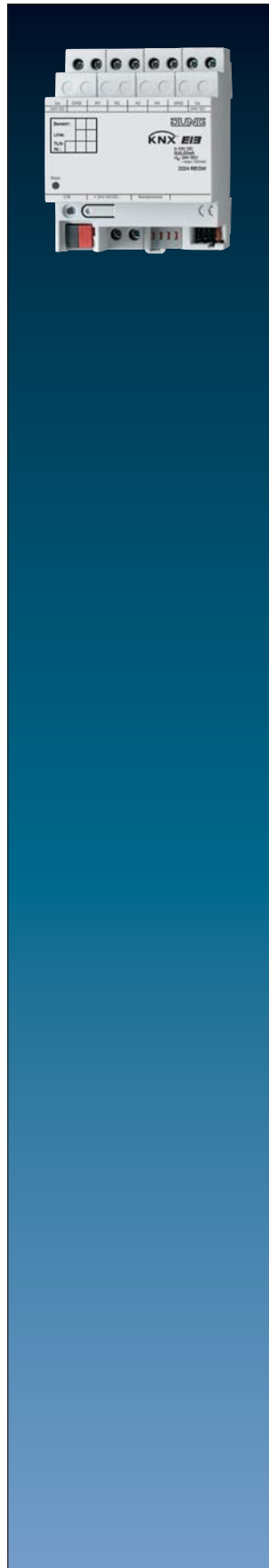

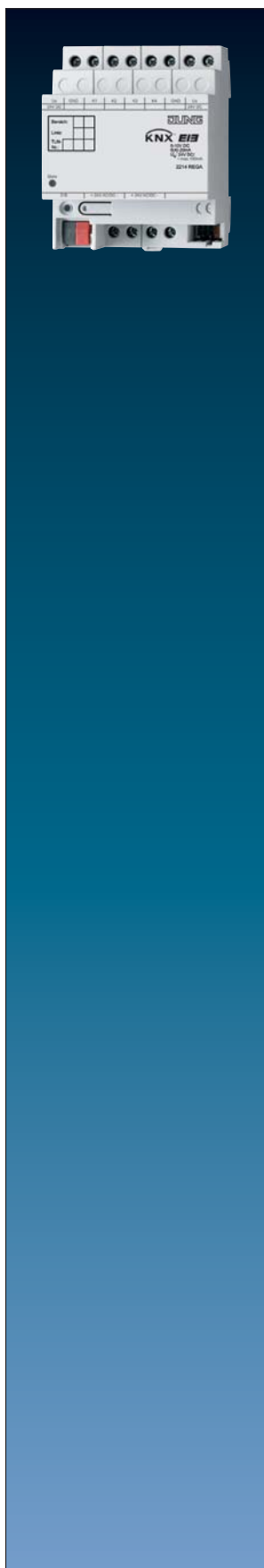

Ref.-no.

Analogue input, 4-gang

Rail mounting device, 4 rail units

ETS product family: Input

Product type: Analogue input 4-gang

2214 REG A

The analogue input processes measured-value data supplied by analogue sensors.

Four analogue sensors in any combination can be connected to the input.

The analogue input evaluates voltage and current signals.

Voltage signals: 0 ... 1 V DC 0 ... 10 V DC

Current signals: 0 ... 20 mA DC 4 ... 20 mA DC

The 4 ... 20 mA current inputs can be monitored for open-circuit conditions.

An optional analogue input extension module allows the extension of the range of analogue measuring sensors to be connected by another four.

The analogue input needs a separate power supply, for example the power supply module ref.-no. WSSV 10.

Technical data

Supply voltage: AC 24 V ~ ± 10 %

Analogue inputs: 4

Format: EIS 5 (2 Byte) or EIS 6 (1 Byte)

Ranges: voltage 0 ... 1 V, 0 ... 10 V;
current 0 ... 20 mA, 4 ... 20 mA;
depending on parameterization

Limit values: 2 per channel

Supply output for sensor: 2 terminal pairs

Voltage: DC 24 V ± 25 %

Total current: max. 100 mA

Ref.-no.

Analogue input extension module, 4-gang

Rail mounting device, 4 rail units
extension module for weather station and analogue input

2214 REGAM

The analogue input extension module exceeds a KNX weather station 2224 REG W or a KNX analogue input 2214 REGA by four additional sensor inputs.

The evaluation of the measured data and the limiting values will be handled by the connected KNX device.

The analogue input extension module evaluates voltage and current signals.

Voltage signals: 0 ... 1 V DC 0 ... 10 V DC

Current signals: 0 ... 20 mA DC 4 ... 20 mA DC

Technical data

External supply

Voltage: AC 24 V ~ ± 15 %
Current consumption: max. 170 mA (incl. sensors)

Analogue inputs: 4

Measuring range per channel

Voltage: 0 ... 1 V, 0 ... 5 V, 0 ... 10 V (DC)
Impedance approx. 18 kΩ

Current: 0 ... 20 mA, 4 ... 20 mA
Impedance approx. 100 kΩ

A/D converter: 14 Bit

Power supply for sensors: DC 24 V max. 100 mA

Remarks on the hardware

Please observe the following basic rules when installing the analogue input extension module:

- One analogue input extension module at maximum can be connected to the weather station.
- Always use the 6-pole system connector (comes with the analogue input extension module) to connect the analog input extension module to the weather station.
- A defective analogue input extension module can be replaced in operation by another one of the same type (disconnect the module from the voltage supply).
After replacement, the weather station will reset after about 25 s. This will re-initialize all inputs and outputs of the weather station and of the modules connected and reset them to their original state.
- Removing or adding any modules without adapting their configuration and subsequent downloading into the weather station is not allowed as this will result in system malfunctioning.
- After the first start, the weather station will run a module scan (status LED: "orange/ON").
Since a new device does not include any configuration by default the status LED will then change to "red/quickly blinking".
- An analog extension input module indicates its readiness for operation by changing its status LED to "quickly blinking".
- After loading a project into the weather station, the status LED will change to "green/ON", with the module turning off its status LED.





Ref.-no.

Power supply AC 24 V ~
for weather station ref.-no.: 2224 REGW
for weather station home ref.-no.: 2224 WH
for analogue input ref.-no.: 2214 REGA
for analogue actuator ref.-no.: 2204.01 REGA
for combi sensor ref.-no.: WS 10 KS...

Rail mounting device, 4 rail units

WSSV 10**Intended use**

- Supplying devices with 24 V AC
- Mounting on DIN rail according to EN 60715 in distribution boxes

Product characteristics

- Two internally connected 24 V outputs
- Overload and short-circuit protection via thermo switch

Technical data

Rated voltage:	AC 230 V ~, 50 Hz, neutral line required
Output current:	max. 1 A
Output voltage:	AC 24 V ~
Storage/transport temperature:	-25 ... +70 °C
Ambient temperature:	-5 ... +40 °C
Relative humidity:	max. 93 % r. h., no condensation
Mounting width:	72 mm (4 rail units)
Wiring:	screw terminals
single wire:	0.5 ... 4 mm ²
stranded with ferrule:	0.14 ... 2.5 mm ²
stranded without ferrule:	0.34 ... 4 mm ²

Combi sensor**WS 10 KS****Combi sensor with DCF77 receiver**

(no KNX device)

WS 10 KSDCF

The combi sensor serves for the measurement of the wind speed, brightness dawn and rain.

The brightness can be measured for three directions, south, east and west, separately.

It will be connected directly to the weather station which evaluates the measured data.

The combi sensor requires an external 24 V AC supply (Power supply WSSV 10).

Technical data

Wind speed:	1 ... 40 m/s
Accuracy:	≤ 0.5 m/s, -20°C ... +60°C
Rain:	Yes / No
Sensitivity:	fine drizzle
Switch On delay:	approx. 3 rain particles
Switch Off delay:	approx. 2 minutes

Brightness

Range:	0 ... 110 KLux
Spectral range:	700 ... 1050 nm
Resolution:	10 bit
Direction:	east, south, west



Ref.-no.

Wind sensor

(no KNX device)

WS 10 W**Intended use**

- Sensor for measuring weather data
- Power is supplied to the sensor and the sensor signals are evaluated via additional electronics, e.g. a weather station
- Detection of the horizontal wind speed
- Vertical installation in outdoor areas, e.g. on walls of buildings, using the supplied mounting bracket

Product characteristics

- Measurement of the rotational speed of the anemometer
- Output with analogue output signal 0 ... 10 V
- Maintenance-free
- Operation without additional power supply possible

Technical data**Power supply**

Rated voltage: DC 18 ... 32 V SELV
 Current consumption: 6 ... 12 mA

Heating

Rated voltage: AC/DC 24 V
 Switch-on current: max. 1 A

Ambient temperature: -25 ... +60 °C

Protection class: III

Protection level: IP 65 (in position for use)

Output signal

Measuring range: 0.9 ... 40 m/s
 Strain: max. 60 m/s (for short periods)
 Output voltage: DC 0 ... 10 V
 Load: min. 1.5 kΩ

Cable type: LiYY 6 x 0.25 mm²

Cable length: approx. 3 m;
 can be extended up to max. 100 m

Dimensions (Ø x H): 134 x 160 mm





Ref.-no.

Rain sensor

(no KNX device)

WS 10 R**Intended use**

- Sensor for measuring weather data
- Power is supplied to the sensor and the sensor signals are evaluated via additional electronics, e.g. weather station ref.-no.: 2224 REG W
- Detection of precipitation
- Installation in outdoor areas, e.g. on walls of buildings, using the supplied 110° mounting bracket

Product characteristics

- Measurement of the electrical conductivity on the sensor surface
- Output by means of analogue output signal: 0 = dry, 10 V = rain
- Heating of the sensor surface with separate 24 V AC/DC power supply, ref.-no.: WSSV 10

Technical data**Power supply**

Rated voltage:	DC 15 ... 30 V
Current consumption:	approx. 10 mA

Heating

Rated voltage:	AC/DC 24 V
Power consumption:	max. 4.5 W

Ambient temperature: -30 ... +70 °C

Protection class: III

Protection level: IP 65

Output signal

Output voltage:	DC 0 / 10 V
Load:	min. 1 kΩ
Reaction time:	max. 4 min

Cable type: LiYY 5 x 0.25 mm²

Cable length: approx. 3 m

can be extended up to: max. 100 m

Dimensions (W x H x D): 83 x 58 x 17 mm

Connections

brown	operating volt. + 24 V
white	correspond. ground
green	output 0 V / 10 V
yellow	heating 24 V
grey	heating 24 V

	Ref.-no.
Brightness sensor Rated voltage 24 V DC range 0 ... 60000 Lux, linear (no KNX device)	WS 10 H

Dawn sensor Rated voltage 24 V DC range 0 ... 255 Lux, linear (no KNX device)	WS 10 D
---	----------------

Temperature sensor Rated voltage 24 V DC range -30 °C ... +70 °C, linear (no KNX device)	WS 10 T
--	----------------

The brightness sensor is used for the measuring and evaluation of the brightness.
 The dawn sensor is used for the measuring and evaluation of the brightness (dawn/dusk).
 The temperature sensor is used for the measuring and evaluation of the temperature.
 The value measured by the sensor is transmitted to an analogue output signal of 0 V – 10 V by the electronics.

Connections:

Plasting housing with PG7 thread + screw and pressure respectively moisture compensation (recommended cable 3 x 0.25 mm²)
 +UB: operating voltage 24 V DC
 GND: corresponding ground
 OUT: output 0 ... 10 V

Technical data

Supply voltage:	24 V DC (15 ... 30 V DC)
Wiring:	screw terminals
Max. cross-sectional area:	2.5 mm ²
Connecting cable:	through screwed conduit entry PG 7
Recommended cable:	3 x 0,25 mm ²
Cable length:	max. 100 m
Output:	0 ... 10 V DC (into a load of at least 1 kΩ, shortcircuit protected)
Ambient temperature:	-30 ... +70 °C
Protection level:	IP 65
Mounting position:	optional



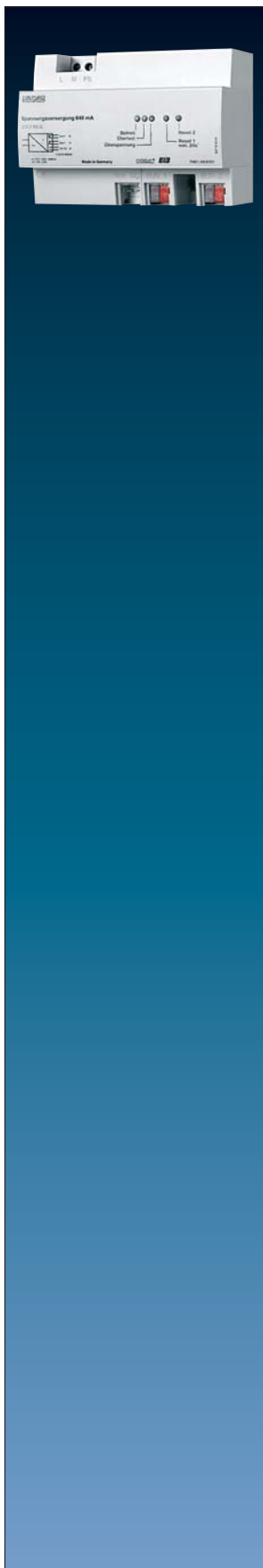

Ref.-no.

Power supply, 640 mA

2 BUS outputs
 1 output 30 V DC
 Rail mounting device, 7 rail units
 ETS product family: System components
 Product type: Power supply

2002 REG

Intended use

- Supplying KNX devices with bus voltage
- Mounting on DIN rail according to EN 60715 in distribution boxes

Product characteristics

- Two outputs with integrated choke for supplying bus lines
- One DC 30 V output for supplying additional devices
- Nominal current can be subdivided to outputs as desired
- Reset switch for each bus line
- Short-circuit proof
- Overvoltage proof

Five LEDs are indicating the different operation status:

LED-indication

1st red LED:	short-circuit or overload
green LED:	normal operation
yellow LED:	over voltage, when bus voltage > 31 V DC
2nd red LED:	reset 1 for bus line 1
3rd red LED:	reset 2 for bus line 2

Technical data

Rated voltage AC:	AC 161 ... 264 V ~, 50/60 Hz
Rated voltage DC:	DC 176 ... 270 V
Power loss:	max. 5 W (under normal operation)
Output current:	640 mA (all outputs)
Outputs BUS (with choke)	
Voltage DC:	28 ... 31 V SELV
Wiring:	KNX bus connection block
Max. bus line length:	350 m
Output DC 30 V (without choke)	
Voltage:	DC 30 V
Wiring:	KNX bus connection block
Ambient temperature:	-5 ... +45 °C
Storage/transport temperature:	-25 ... +70 °C
Mounting width:	126 mm (7 rail units)
Wiring, mains:	screw terminals
single wire:	0.2 ... 4 mm ²
stranded without ferrule:	0.75 ... 4 mm ²
stranded with ferrule:	0.5 ... 2.5 mm ²



Ref.-no.

Power supply, 320 mA

1 output BUS

1 output 30 V DC

Rail mounting device, 4 rail units

ETS product family: System components

Product type: Power supply

2005 REG**Intended use**

- Supplying KNX devices with bus voltage
- Mounting on DIN rail according to EN 60715 in distribution boxes

Product characteristics

- One output with integrated choke for supplying a bus line
- One DC 30 V output for supplying additional devices
- Nominal current can be subdivided to outputs as desired
- Reset switch for bus line
- Short-circuit proof
- Overvoltage proof

Four LEDs are indicating the different operation status:

LED-indication

1st red LED:	short-circuit or overload
green LED:	normal operation
yellow LED:	over voltage, when bus voltage > 31 V DC
2nd red LED:	reset 1 for bus line 1

Technical data

Rated voltage AC:	AC 161 ... 264 V ~, 50/60 Hz
Rated voltage DC:	DC 176 ... 270 V
Power loss:	max. 5 W (under normal operation)
Output current:	320 mA (all outputs)
Outputs BUS (with choke)	
Voltage:	DC 28 ... 31 V SELV
Wiring:	KNX bus connection block
Max. bus line length:	350 m
Output DC 30 V (without choke)	
Voltage:	DC 30 V
Wiring:	KNX bus connection block
Ambient temperature:	-5 ... +45 °C
Storage/transport temperature:	-25 ... +70 °C
Mounting width:	72 mm (4 rail units)
Wiring, mains:	screw terminals
single wire:	0.2 ... 4 mm ²
stranded without ferrule:	0.75 ... 4 mm ²
stranded with ferrule:	0.5 ... 2.5 mm ²

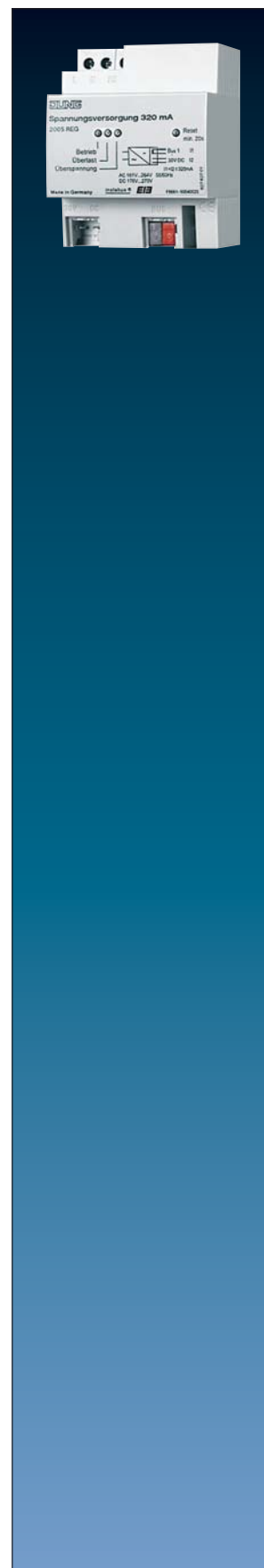

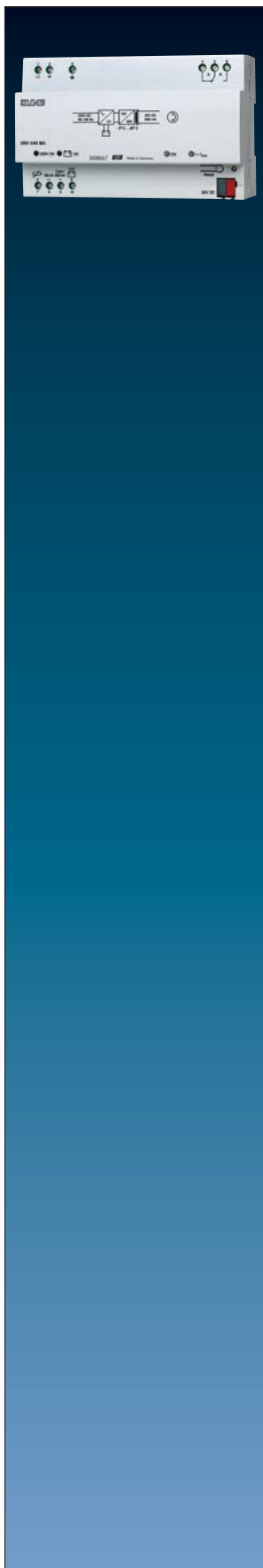

Ref.-no.

Uninterruptible KNX power supply 640 mA

Rail mounting device, 8 rail units

ETS product family: System components

Product type: Power supply

USV 640 MA**Intended use**

- Supplying KNX devices with bus voltage
- Interruption-free operation of the bus line in the event of power failure with rechargeable battery
- Mounting on DIN rail according to EN 60715 in distribution boxes

Product characteristics

- Generation and monitoring of the KNX bus voltage
- With lead gel battery (ref.-no. BGA 12 AH) and cable set (ref.-no. KSB 4, KSE 2): buffering of the KNX bus voltage in the event of mains failure
- Up to 2 batteries can be connected
- Short-circuit proof
- Overvoltage proof
- Alarm contact for fault message

Technical data

Power supply

Rated voltage: AC 195 ... 255 V ~

Rated frequency: 45 ... 65 Hz

Power consumption: max. 50 VA

Power loss: max. 10 W

Ambient temperature: -5 ... +45 °C

Storage/transport temperature: -25 ... +70 °C

(Storage above +45 °C reduces the lifetime)

Bus output voltage: DC 28 ... 31 V SELV

Output current: 640 mA (short-circuit proof)

Short-circuit current: max. 1.4 A

Wiring: terminal

Connection of fault indicator

Switching voltage AC: AC 12 ... 230 V ~

Switching voltage DC: DC 12 ... 24 V

Switching current AC: max. 6 A

Switching current DC: max. 4 A

Battery connection

Cable length: approx. 2 m

Fine-wire fuse: T 6.3 A H 250 V

Rated voltage: DC 12 V

Rated charging current: 650 mA, at battery capacity > 5 Ah

150 mA, at battery capacity < 5 Ah

Mains failure bridging time (battery like new)

1 battery 12 V / 12 Ah: approx. 5.5 h

2 batteries 12 V / 12 Ah: approx. 11 h

Mounting width: 144 mm (8 rail units)

Terminals: screw terminals

single wire: 0.5 ... 4 mm²stranded with ferrule: 0.2 ... 2.5 mm²

Ref.-no.

Lead gel battery (rechargeable)**BGA 12 AH**

In combination with the uninterruptible KNX power supply, the lead-gel battery serves for the buffering of the system voltage. Max. two lead-gel batteries can be connected in parallel to the power supply. In that case two equal lead-gel batteries must be used. For the connection of a single battery the 4-wire cable set must be used, for the connection of two batteries the 4-wire cable set must be used for the first one, the second one must be connected with the 2-wire cable set. The durability of lead-gel batteries is up to 5 years.

Technical data

Power supply	
Rated voltage:	12 V DC
Battery capacity:	12 Ah
Dimensions (W x H x D):	151 x 94 x 98 mm
Weight:	4.2 kg
Ambient temperature	
Operation:	-20 ... +50 °C

Cable set

Basis	KSB 4
Extension	KSE 2

For the connection of the uninterruptible KNX power supply and the lead-gel battery the 4-wire cable set (for one battery) must be used. For two batteries the 4-wire and the 2-wire set must be used. The 4-wire cable set has an integrated fuse and a temperature sensor, the 2-wire cable set has only an integrated fuse.

Technical data KSB 4

Cable	
Wires:	4-wire cable
Cross-sectional area:	0.75 mm ²
Length:	2 m
Colour battery connection:	red (12 V battery) black (GND battery)
Colour temperature sensor:	white (12 V temp. sensor) yellow (GND temp. sensor)
Terminals	
Battery connection:	for the connection to the uninterruptible power supply: ferrules for the connection to the battery: cable lug (6.3 x 0.8 mm)
Temperature sensor:	ferrule
Fuse, model:	exchangeable fuse with in-line fuse holder (screw cap)
Fuse, type:	5 x 20 mm, T6.3 H 250 V

Technical data KSE 2

Cable	
Wires:	2-wire cable
Cross-sectional area:	0.75 mm ²
Length:	2 m
Colour battery connection:	red (12 V battery) black (GND battery)
Terminals	
Battery connection:	for the connection to the uninterruptible power supply: ferrules for the connection to the battery: cable lug (6.3 x 0.8 mm)
Fuse, model:	exchangeable fuse with in-line fuse holder (screw cap)
Fuse, type:	5 x 20 mm, T6.3 H 250 V

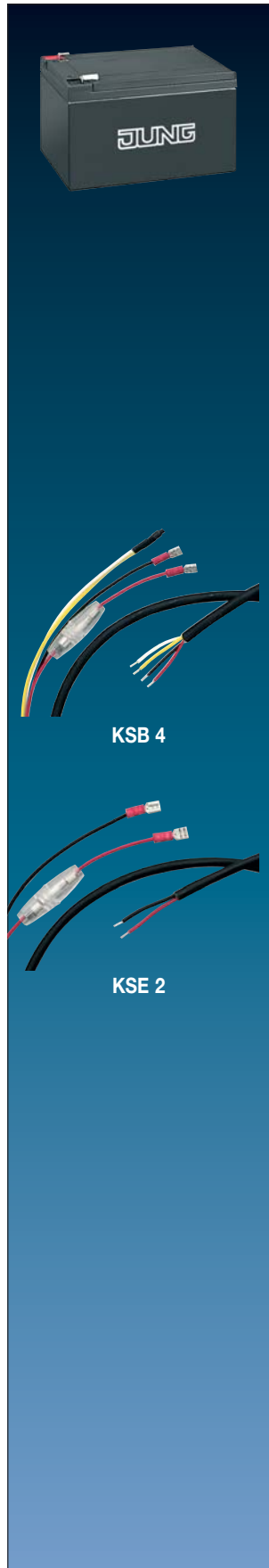



Ref.-no.

Line coupler

Rail mounting device, 2 rail units
 ETS product family: System components
 Product type: Line coupler

2142 REG

Function

The coupler connects two KNX lines together and guarantees electrical isolation between these lines. The exact function of the device is defined by the address and the selected application.

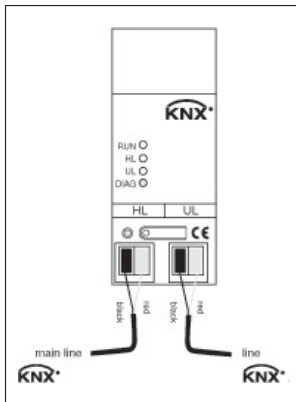

Line coupler

Connection of a line and a main line with or without a filter function.
 The coupler is physically assigned to the secondary line (here: line).

Backbone coupler

Connection of a main line and a backbone line with or without a filter function.
 The coupler is physically assigned to the secondary line (here: main line).

Amplifier

Preparation and repetition of telegrams on a line, no filter function.
 Subdivision of a line into max. 4 independent line segments = max. 3 line repeaters per line connected in parallel.
 A separate KNX power supply is required for each line segment.

Technical data

Power supply:	21 ... 32 V DC via the primary line
Current consumption	
superordinate line:	approx. 6 mA
subordinate line:	approx. 8 mA
Wiring:	KNX bus connection block for primary and secondary line
Mounting:	on DIN rail
Ambient temperature:	-5 ... +45 °C
Storing temperature:	-25 ... +70 °C
Protection class:	III acc. EN 61 140
Mounting width:"	36 mm (2 rail units)

Commissioning

During commissioning of a project with area/line couplers, the following sequence of operations should be observed:

1. Project design of the KNX installation (physical address, group addresses, parameters).
2. At first, the physical addresses of the couplers and their application programs must be programmed and then the physical addresses of the other KNX devices. Thereafter, the applications can be loaded into the KNX devices (actuators, sensors, etc.). For testing of a KNX installation, especially in the modification phase before project design completion, it is recommended to set the parameters "Group telegrams main line → line" and "Group telegrams line → main line" at first to "Transmit all". This means that any programmed filter tables are not yet taken into account in the testing phase.
3. The filter tables can then be generated on completion of project design and commissioning (in the ETS 2 under menu item: Commissioning/ Project design – generating filter tables / ETS 3 generates them automatically).
4. Finally, the filter tables should be programmed into the couplers. The filter tables are loaded automatically when the complete application is downloaded or also during partial programming of the "group addresses". Especially with smaller projects, the filter tables can be generated and programmed already under item 2. (together with the programming of the physical addresses for the couplers). In larger projects, it is absolutely important to program filter tables in order to avoid unnecessarily high bus loads and thus communication problems.

The area/line coupler can be programmed from the higher-order but also from the subordinate line.

Topology

The area/line coupler transmits telegrams between a subordinate line and a higher-order line (line coupler: line – main line, area coupler: mainline – backbone bus). In the project design phase, the function of the device is defined by the physical address as follows:

Area coupler (AC) A.0.0 $(1 \leq A \leq 15)$

Line coupler (LC) A.L.0 $(1 \leq A \leq 15, 1 \leq L \leq 15)$

Each line has a power supply (PS) of its own and is electrically isolated from the bus. With line couplers, up to 15 lines can be grouped into an area. With area couplers (AC), up to 15 areas can be interconnected.

From a logical point of view, area/line couplers are assigned to the pertaining subordinate line. The hierarchy of line and area couplers in a KNX system is thus as follows:

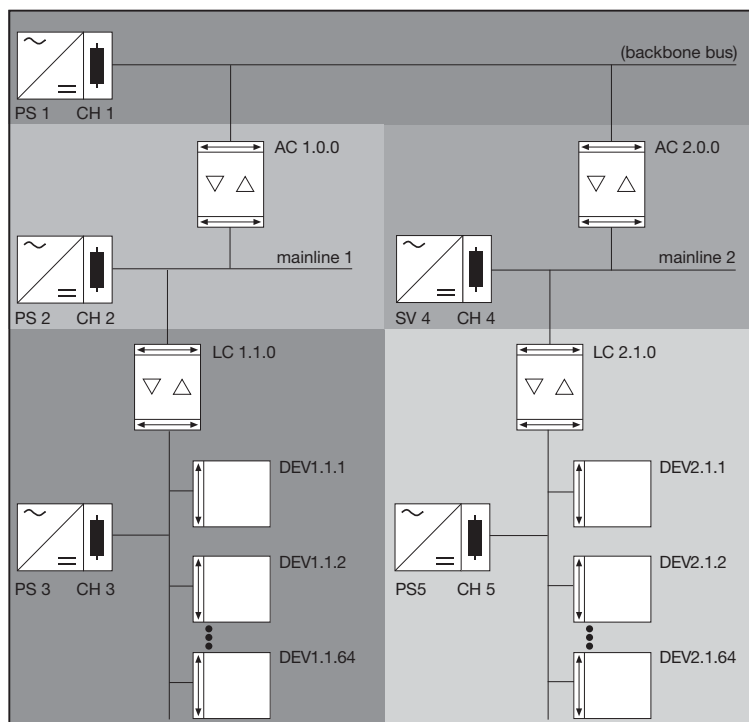

AC = Area coupler
 DEV = Bus device
 LC = Line coupler
 PS = Power supply
 CH = Choke

The coupler logics is supplied with electric power from the higher-order line.

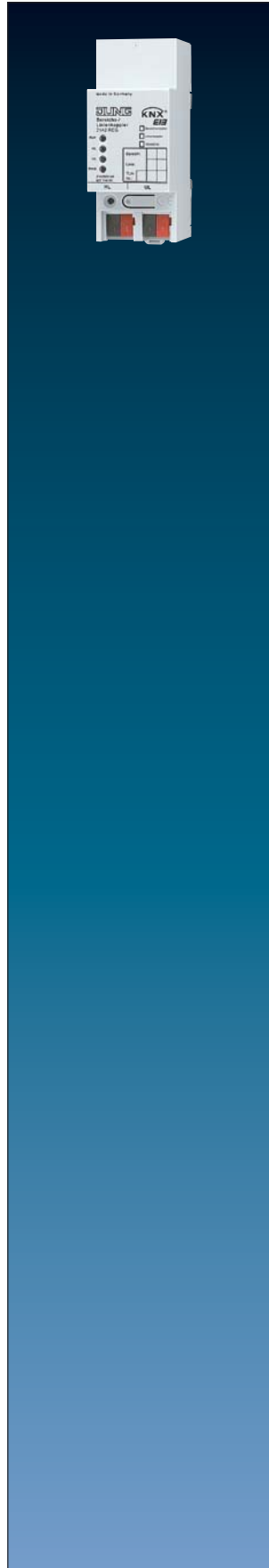

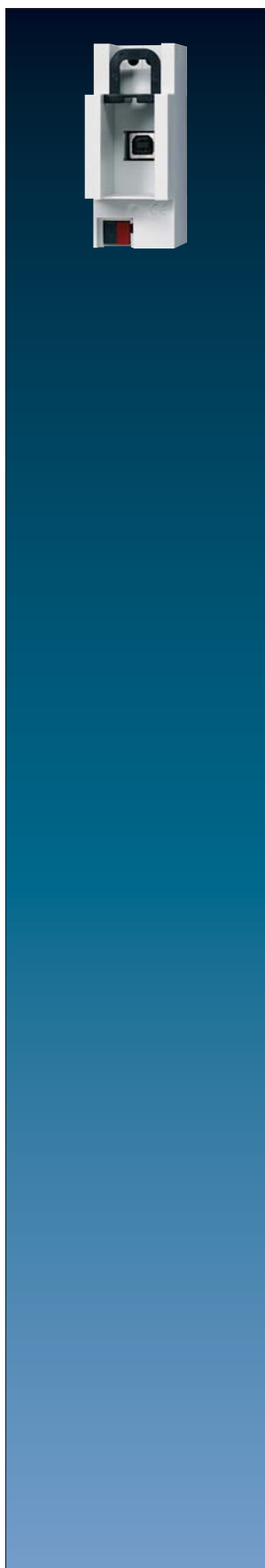

Ref.-no.

USB data interface

Rail mounting device, 2 rail units

2130 USB REG

The USB data interface enables the coupling of a PC for the addressing, programming and diagnoses of KNX components. The power is fully supplied by the connected PC via the USB interface. This means that the USB data interface is no longer connected for the KNX if the USB cable is not plugged in. The device is only programmed locally with a physical address via the connected PC and therefore does not have a programming button or programming LED. The firmware of the USB data interface can be updated via a PC and is therefore safeguarded for future standards.

Note

The USB data interface is supported by ETS 3 software from version "a" upwards and by the PC operating systems Windows 98, 98 SE, ME, 2000 and XP.

Connection

The connection to the KNX is carried out with the aid of the bus connecting terminal. The USB connection is carried out with a certified USB cable (1 x B plug required) with a max. length of 5 m.

Technical data

Power supply:	via USB port of the PC
Wiring:	KNX bus connection block
USB port:	USB socket, type B
Transfer rate:	9600 Baud
Transmission protocol:	compatible with USB 1.1/2.0
Length of USB cable:	max. 5 m
Ambient temperature:	-5 ... +45 °C
Storing temperature:	-25 ... +70 °C
Protection class:	II
Mounting width:	36 mm (2 rail units)

Ref.-no.

USB data interface**2130 USB**

The USB data interface enables the coupling of a PC for the addressing, programming and diagnoses of KNX components. The power is fully supplied by the connected PC via the USB interface. This means that the USB data interface is no longer connected for the KNX if the USB cable is not plugged in. The device is only programmed locally with a physical address via the connected PC and therefore does not have a programming button or programming LED. The firmware of the USB data interface can be updated via a PC and is therefore safeguarded for future standards.

Connection:

The connection to the KNX is carried out with the aid of the bus connecting terminal. The USB connection is carried out with a certified USB cable (1 x B plug required) with a max. length of 5 m.

Technical data

Power supply:	via USB port of the PC
Connection	
KNX:	KNX bus connection block
USB port:	USB socket, type B
Transfer rate:	9600 Baud
Transmission protocol:	compatible with USB 1.1/2.0
Length of USB cable:	max. 5 m
Ambient temperature:	-5°C ... +45°C
Storing temperature:	-25°C ... +70°C
Protection class:	II

For suitable covers and frames please refer to our main catalogue.

Suitable covers:**AS 500 / A 500 / A plus**

ivory	A 569 PLT
white	A 569 PLT WW
aluminium	A 569 PLT AL

CD 500 / CD plus

		with inscription plate
ivory	569 T	569 TNA
white	CD 569 T WW	CD 569 TNA WW
blue	CD 569 T BL	CD 569 TNA BL
brown	CD 569 T BR	CD 569 TNA BR
grey	CD 569 T GR	CD 569 TNA GR
light grey	CD 569 T LG	CD 569 TNA LG
red	CD 569 T RT	CD 569 TNA RT
black	CD 569 T SW	CD 569 TNA SW
gold-bronze	CD 569 T GB	CD 569 TNA GB
platinum	CD 569 T PT	CD 569 TNA PT

LS 990 / LS plus / Aluminium / Stainless Steel / Anthracite / Chrom / Gold

ivory	LS 969 T
white	LS 969 T WW
light grey	LS 969 T LG

Metal versions

aluminium	AL 2969 T
stainless Steel	ES 2969 T
anthracite	
(lacquered aluminium)	AL 2969 T AN
chrom	GCR 2969 T
gold (coloured)	GO 2969 T

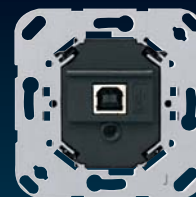

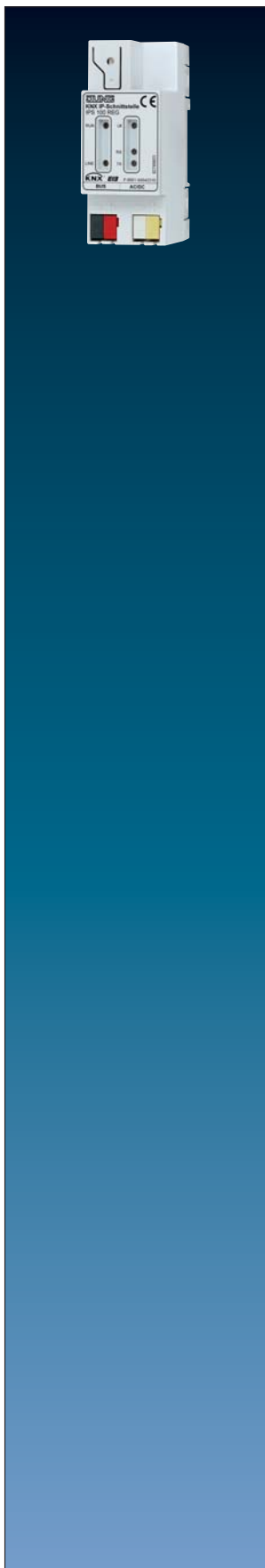

Ref.-no.

IP Interface

Rail mounting device, 2 rail units
 ETS product family: Communication
 Product type: IP Interface

IPS 100 REG

Product characteristics

- Connection of KNX devices with PCs or other data processing devices via IP, e.g. use as a data interface
- Operating as a KNX interface in the IP network via EIBnet/IP tunnelling
- Access to the KNX system via the IP network
- Supply via an external power supply (accessory)
- Electrical separation between KNX and the IP network

Technical data

Power supply	
Rated voltage:	AC/DC 12 ... 30 V SELV
Wiring:	terminal
Power consumption:	max. 800 mW
IP connection:	RJ45 socket
Transfer rate:	10 Mbit/s
Protocols:	ARP, ICMP, IGMP, UDP/IP, DHCP, KNXnet/IP (Core, Tunneling, Device Management)
IP communication:	Ethernet 10BaseT
Rated voltage KNX:	DC 21 ... 32 V SELV
Power consumption KNX:	approx. 290 mW
Wiring, KNX:	terminal
Ambient temperature:	-5 ... +45 °C
Storage/transport temperature:	-25 ... +70 °C
Mounting width:	36 mm (2 rail units)

Ref.-no.

IP Router

Rail mounting device, 2 rail units

ETS product family: System components

Product type: IP router

IPR 100 REG**Product characteristics**

- Interconnection of KNX lines via local area data networks (LAN) based on the use of the IP protocol (IP = Internet Protocol)
- Use as line / area coupler (filter tables)
- Interconnection of KNX devices with PCs (e.g. KNX Smart Pilot, ref.-no.: SP .. FAPVD..) or other DP devices via IP (use as data interface)
- Power supply via external 24 V AC/DC
- Transmission of KNX system failure message to the PC
- Electrical separation between KNX and IP network

Technical data

Power supply

Rated voltage: AC/DC 12 ... 30 V SELV

Wiring: terminal

Power consumption: max. 800 mW

IP connection: RJ45 socket

Transfer rate: 10 Mbit/s

Protocols: ARP, ICMP, IGMP, UDP/IP, DHCP, KNXnet/IP
(Core, Routing, Tunneling, Device Management)

IP communication: Ethernet 10BaseT

Rated voltage KNX: DC 21 ... 32 V SELV

Current consumption KNX: typ. 10 mA

Wiring, KNX: terminal

Ambient temperature: -5 ... +45 °C

Storage/transport temperature: -25 ... +70 °C

Mounting width: 36 mm (2 rail units)

KNX logic module

Rail mounting device, 2 rail units

ETS product family: Controller

Product type: Controller

ABL/S2.1**Product characteristics**

- Can be parameterised via ETS3 and a graphic surface with drag & drop function
- 50 logical functions (AND, OR, EXOR)
- 50 unidirectional and bidirectional gates
- 30 timers (with ON/OFF delay, pulse duration, staircase lighting function)
- 10 comparators



Actuators

Switching, dimming, blinds, heating and ventilation, with or without an extension input or connection – JUNG offers the corresponding KNX actuators for any application. Depending on the local conditions, the appropriate design can be selected from the broad product range of DIN rail mounted and flush-mounted variants.



Flush-mounted blinds actuator,
1-gang with satellite input



Flush-mounted switch actuator,
1-gang with satellite input

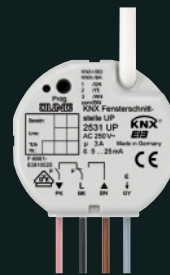

Flush-mounted room climate
interface with satellite

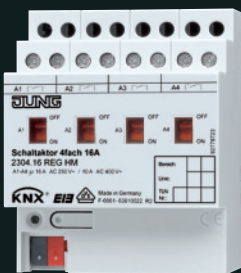

Switch actuator with C-load,
4-gang with current detection



Switch / blinds actuator
4/2-gang

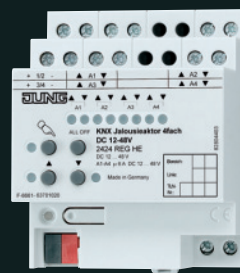

Blinds actuator,
4-gang DC 12 – 48 V

JUNG

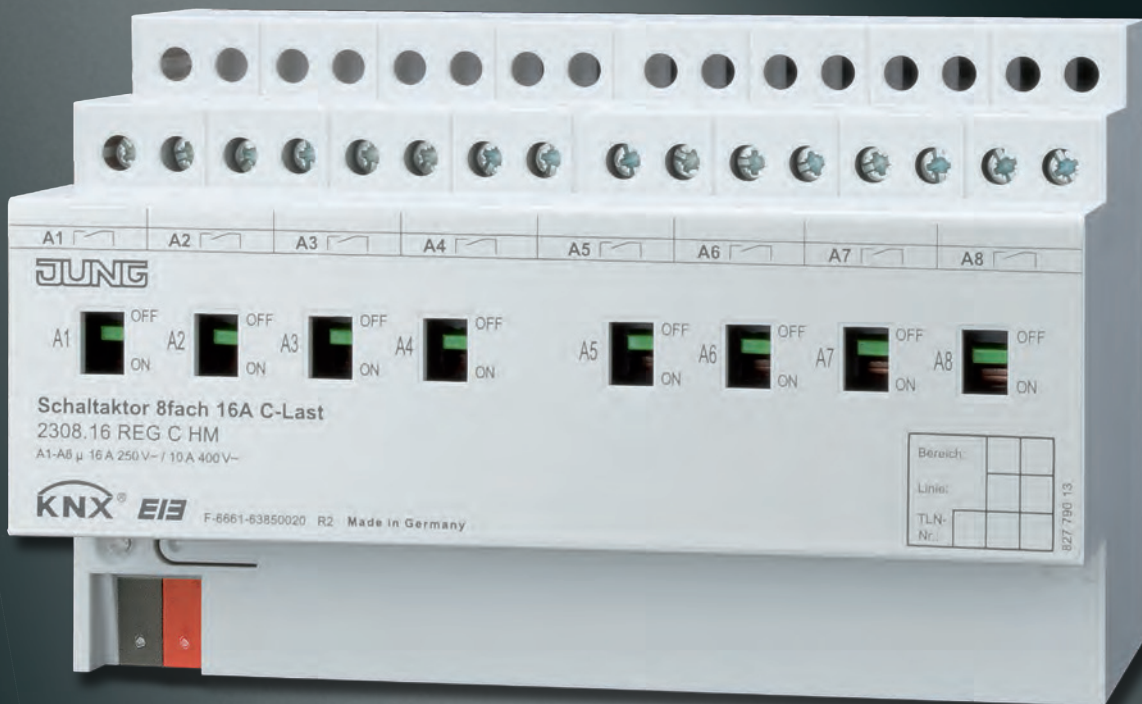

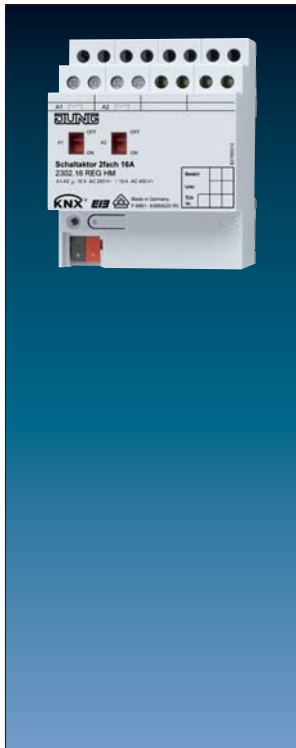

Ref.-no.

Switch actuator, 2-gang

Rail mounting device, 4 rail units

2 make contacts with manual mechanical operation and status indicator

ETS product family: Output

Product type: Binary output

2302.16 REGHM**Intended use**

- Switching of 230 V AC or 24 V AC/DC electrical loads with floating contacts
- Mounting on DIN rail according to EN 60715 in distribution boxes

Product characteristics

- Manual operation of the relay independently of the bus
- Operation as NO or NC contacts (normally open or normally closed)
- Logic and restraint function
- Switching feedback (bus operation only)
- Switch position display
- Central switching function with centralized feedback
- Disabling function for each channel
- Timing functions: switch-on or switch-off delay time, staircase lighting timer with pre-warning function
- Integration into light scenes
- Operating hours meter, configurable via bus
- Input monitoring for cyclical updating with safety circuit
- No additional power supply necessary

Technical data

Rated voltage KNX:	DC 21 ... 32 V SELV
Wiring, KNX:	KNX bus connection block
Power consumption KNX:	typical 150 mW
Power loss:	max. 2 W
Ambient temperature:	-5 ... +45 °C
Storage/transport temperature:	-25 ... +70 °C
Mounting width:	72 mm (4 rail units)
Wiring, outputs:	screw terminals
	single wire: 0.5 ... 4 mm ²
	stranded without ferrule: 0.5 ... 4 mm ²
	stranded with ferrule: 0.5 ... 2.5 mm ²

Switching outputs

Contact type:	floating relay contacts (μ contact)
Switching voltage AC:	AC 250 / 400 V
Switching current 230 V AC1:	16 A
Switching current 230 V AC3:	10 A
Switching current 400 V AC1:	10 A
Switching current 400 V AC3:	6 A
Fluorescent lamps:	10 AX
ohmic load:	3680 W
capacitive load:	10 A / 140 μF
Switching voltage DC:	DC 12 ... 24 V
Switching current DC:	16 A
Min. switching current:	100 mA
Switch-on current 150 μs:	400 A
Switch-on current 600 μs:	200 A

Lamp loads

Incandescent lamps:	2500 W
HV halogen lamps:	2500 W
LV halogen lamps with conventional transformer:	1200 VA
TRONIC transformer:	1500 W
Fluorescent lamps T5/T8 non-compensated:	2500 W
parallel compensated:	1300 W / 140 μF
lead-lag circuit:	2300 W / 140 μF
Compact fluorescent lamps non-compensated:	2500 W
parallel compensated:	1300 W / 140 μF
Mercury vapour lamps non-compensated:	2000 W
parallel compensated:	2000 W / 140 μF

Ref.-no.

Switch actuator, 4-gang

Rail mounting device, 4 rail units

4 make contacts with manual mechanical operation and status indicator

ETS product family: Output

Product type: Binary output

2304.16 REGHM**Intended use**

- Switching of 230 V AC or 24 V AC/DC electrical loads with floating contacts
- Mounting on DIN rail according to EN 60715 in distribution boxes

Product characteristics

- Manual operation of the relay independently of the bus
- Operation as NO or NC contacts
- Logic and restraint function
- Switching feedback (bus operation only)
- Switch position display
- Central switching function with centralized feedback
- Disabling function for each channel
- Timing functions: switch-on or switch-off delay time, staircase lighting timer with pre-warning function
- Integration into light scenes
- Operating hours meter, configurable via bus
- Input monitoring for cyclical updating with safety circuit
- No additional power supply necessary

Technical data

Rated voltage KNX:	DC 21 ... 32 V SELV
Wiring, KNX:	KNX bus connection block
Power consumption KNX:	typical 150 mW
Power loss:	max. 4 W
Ambient temperature:	-5 ... +45 °C
Storage/transport temperature:	-25 ... +70 °C
Mounting width:	72 mm (4 rail units)
Wiring, outputs:	screw terminals
	single wire: 0.5 ... 4 mm ²
	stranded without ferrule: 0.5 ... 4 mm ²
	stranded with ferrule: 0.5 ... 2.5 mm ²

Switching outputs

Contact type:	floating relay contacts (μ contact)
Switching voltage AC:	AC 250 / 400 V
Switching current 230 V AC1:	16 A
Switching current 230 V AC3:	10 A
Switching current 400 V AC1:	10 A
Switching current 400 V AC3:	6 A
Fluorescent lamps:	10 AX
ohmic load:	3680 W
capacitive load:	10 A / 140 μ F
Switching voltage DC:	DC 12 ... 24 V
Switching current DC:	16 A
Min. switching current:	100 mA
Switch-on current 150 μ s:	400 A
Switch-on current 600 μ s:	200 A

Lamp loads

Incandescent lamps:	2500 W
HV halogen lamps:	2500 W
LV halogen lamps with conventional transformer:	1200 VA
TRONIC transformer:	1500 W
Fluorescent lamps T5/T8 non-compensated:	2500 W
parallel compensated:	1300 W / 140 μ F
lead-lag circuit:	2300 W / 140 μ F
Compact fluorescent lamps non-compensated:	2500 W
parallel compens.::	1300 W / 140 μ F
Mercury vapour lamps non-compensated:	2000 W
parallel compensated:	2000 W / 140 μ F

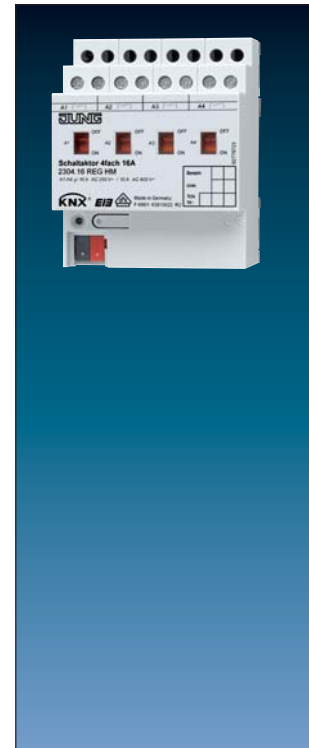

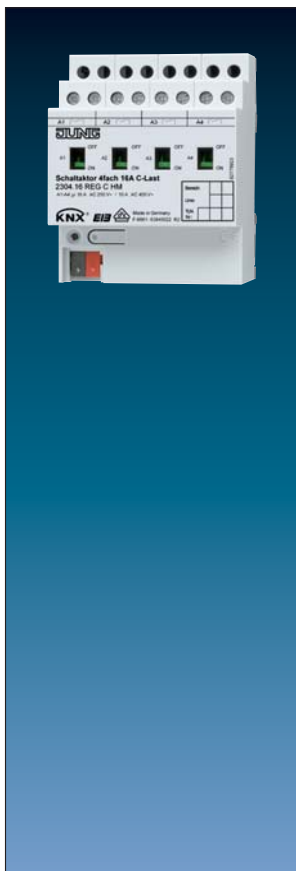

Ref.-no.

Switch actuator with C-load, 4-gang with current detection

Rail mounting device, 4 rail units
 4 make contacts with manual mechanical operation and status indicator
 Only with the ETS 3.0d version or later versions the full functionality will be available.
 ETS product family: Output
 Product type: Binary output

2304.16 REGCHM

Intended use

- Switching of 230 V AC or 24 V AC/DC electrical loads with floating contacts
- Mounting on DIN rail according to EN 60715 in distribution boxes

Product characteristics

- Manual operation of the relay independently of the bus
- Operation as NO or NC contacts
- Logic and restraint function
- Switching feedback (bus operation only)
- Switch position display
- Central switching function with centralized feedback
- Disabling function for each channel
- Timing functions: switch-on or switch-off delay time, staircase lighting timer with pre-warning function
- Integration into light scenes
- Operating hours meter, configurable via bus
- Input monitoring for cyclical updating with safety circuit
- No additional power supply necessary
- Current detection: measurement of the load current for each output
- Monitoring of threshold values for load monitoring, e.g. for reporting load drop-out
- Switching of capacitive loads and the resulting high switch-on currents

Technical data

Rated voltage KNX:	DC 21 ... 32 V SELV	Mounting width:	72 mm (4 rail units)
Wiring, KNX:	KNX bus connection block	Wiring, outputs:	screw terminals
Power consumption KNX:	typical 240 mW	single wire:	0.5 ... 4 mm ²
Power loss:	max. 4 W	stranded without ferrule:	0.5 ... 4 mm ²
Ambient temperature:	-5 ... +45 °C	stranded with ferrule:	0.5 ... 2.5 mm ²
Storage/transport temperature:	-25 ... +70 °C		

Current detection (sine)

Mains frequency:	50 / 60 Hz	Measuring range:	0.25 ... 16 A
Accuracy (≤ 1 A):	±100 mA	Accuracy (> 1 A):	±8 % of curr. val.

Switching outputs

Contact type:	floating relay contacts (μ contact)
Switching voltage AC:	AC 250 / 400 V
Switching current 230 V AC1:	16 A
Switching current 230 V AC3:	10 A
Switching current 400 V AC1:	10 A
Switching current 400 V AC3:	6 A
Fluorescent lamps:	16 AX
ohmic load:	3680 W
capacitive load:	16 A / 200 μF
Switching voltage DC:	DC 12 ... 24 V
Switching current DC:	16 A
Min. switching current:	100 mA
Switch-on current 150 μs:	600 A
Switch-on current 600 μs:	300 A

Lamp loads

Incandescent lamps	
HV halogen lamps:	3680 W
LV halogen lamps with conventional transformer:	2000 VA
TRONIC transformer:	2500 W
Fluorescent lamps T5/T8 non-compensated:	3680 W
parallel compensated:	2500 W / 200 μF
lead-lag circuit:	3680 W / 200 μF
Compact fluorescent lamps non-compensated:	3680 W
parallel compensated:	2500 W / 200 μF
Mercury vapour lamps non-compensated:	3680 W
parallel compensated:	3680 W / 200 μF

Ref.-no.

Switch actuator, 6-gang

Rail mounting device, 4 rail units
 6 make contacts
 ETS product family: Output
 Product type: Binary output

2136.6 REG**Intended use**

- Switching of 230 V AC electrical loads with floating contacts
- Mounting on DIN rail according to EN 60715 in distribution boxes

Product characteristics

- Operation as NO or NC contacts
- Logic and restraint function
- Switching feedback (bus operation only)
- Disabling function for each channel
- Timing functions: switch-on or switch-off delay time, staircase lighting timer with pre-warning function
- No additional power supply necessary

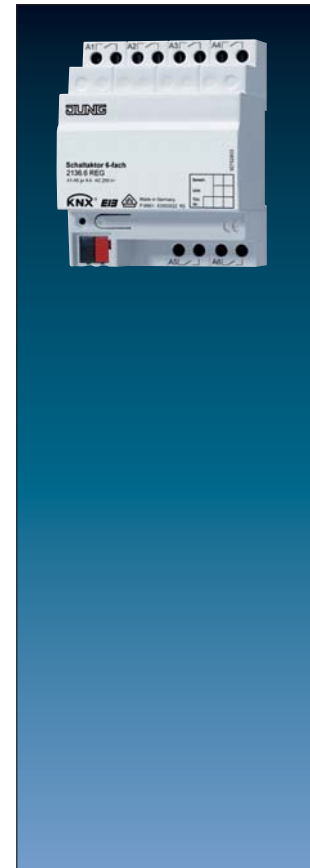
**Technical data**

Output	
Number:	6
Contact type:	floating relay contacts (μ contact)
Switch type:	make contact
Rated voltage:	AC 230 V ~, 50 Hz, neutral line required
Rated current:	6 A / AC-1 (ohmic load)
Wiring:	screw terminals
single wire:	0.5 ... 4 mm ²
stranded without ferrule:	0.5 ... 4 mm ²
stranded with ferrule:	0.5 ... 2.5 mm ²

Switching capacities

Incandescent lamps:	1000 W
Fluorescent lamps	
– non-compensated, $\cos \varphi = 0.5$:	500 W
– parallel compensated, $\cos \varphi = 1$:	2 x 58 W / 14 μ F, 3 x 36 W / 14 μ F, 6 x 18 W / 14 μ F
– lead-lag circuit, $\cos \varphi = 1$:	2 x 500 W

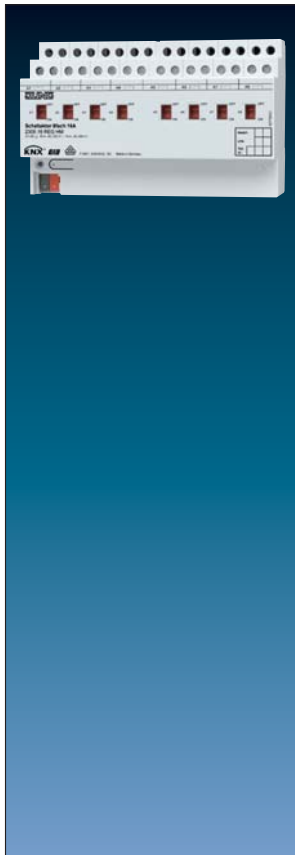

Ref.-no.

Switch actuator, 8-gang

Rail mounting device, 8 rail units

8 make contacts with manual mechanical operation and status indicator

Only with the ETS 3.0d version or later versions the full functionality will be available.

ETS product family: Output

Product type: Binary output

2308.16 REGHM**Intended use**

- Switching of 230 V AC or 24 V AC/DC electrical loads with floating contacts
- Mounting on DIN rail according to EN 60715 in distribution boxes

Product characteristics

- Manual operation of the relay independently of the bus
- Operation as NO or NC contacts
- Logic and restraint function
- Switching feedback (bus operation only)
- Switch position display
- Central switching function with centralized feedback
- Disabling function for each channel
- Timing functions: switch-on or switch-off delay time, staircase lighting timer with pre-warning function
- Integration into light scenes
- Operating hours meter, configurable via bus
- Input monitoring for cyclical updating with safety circuit
- No additional power supply necessary

Technical data

Rated voltage KNX:	DC 21 ... 32 V SELV
Wiring, KNX:	KNX bus connection block
Power consumption KNX:	typical 150 mW
Power loss:	max. 8 W
Ambient temperature:	-5 ... +45 °C
Storage/transport temperature:	-25 ... +70 °C
Mounting width:	144 mm (8 rail units)
Wiring, outputs:	screw terminals
	single wire: 0.5 ... 4 mm ²
	stranded without ferrule: 0.5 ... 4 mm ²
	stranded with ferrule: 0.5 ... 2.5 mm ²

Switching outputs

Contact type:	floating relay contacts (μ contact)
Switching voltage AC:	AC 250 / 400 V
Switching current 230 V AC1:	16 A
Switching current 230 V AC3:	10 A
Switching current 400 V AC1:	10 A
Switching current 400 V AC3:	6 A
Fluorescent lamps:	10 AX
ohmic load:	3680 W
capacitive load:	10 A / 140 μF
Switching voltage DC:	DC 12 ... 24 V
Switching current DC:	16 A
Min. switching current:	100 mA
Switch-on current 150 μs:	400 A
Switch-on current 600 μs:	200 A

Lamp loads

Incandescent lamps:	2500 W
HV halogen lamps:	2500 W
LV halogen lamps with conventional transformer:	1200 VA
TRONIC transformer:	1500 W
Fluorescent lamps T5/T8 non-compensated:	2500 W
parallel compensated:	1300 W / 140 μF
lead-lag circuit:	2300 W / 140 μF
Compact fluorescent lamps non-compensated:	2500 W
parallel compens.:	1300 W / 140 μF
Mercury vapour lamps non-compensated:	2000 W
parallel compensated:	2000 W / 140 μF

#

Ref.-no.

**Switch actuator with C-load, 8-gang
with current detection**

Rail mounting device, 8 rail units

8 make contacts with manual mechanical operation and status indicator

Only with the ETS 3.0d version or later versions the full functionality will be available.

ETS product family: Output

Product type: Binary output

2308.16 REGCHM**Intended use**

- Switching of 230 V AC or 24 V AC/DC electrical loads with floating contacts
- Mounting on DIN rail according to EN 60715 in distribution boxes

Product characteristics

- Manual operation of the relay independently of the bus
- Operation as NO or NC contacts
- Logic and restraint function
- Switching feedback (bus operation only)
- Switch position display
- Central switching function with centralized feedback
- Disabling function for each channel
- Timing functions: switch-on or switch-off delay time, staircase lighting timer with pre-warning function
- Integration into light scenes
- Operating hours meter, configurable via bus
- Input monitoring for cyclical updating with safety circuit
- No additional power supply necessary
- Current detection: measurement of the load current for each output
- Monitoring of threshold values for load monitoring, e.g. for reporting load drop-out
- Switching of capacitive loads and the resulting high switch-on currents

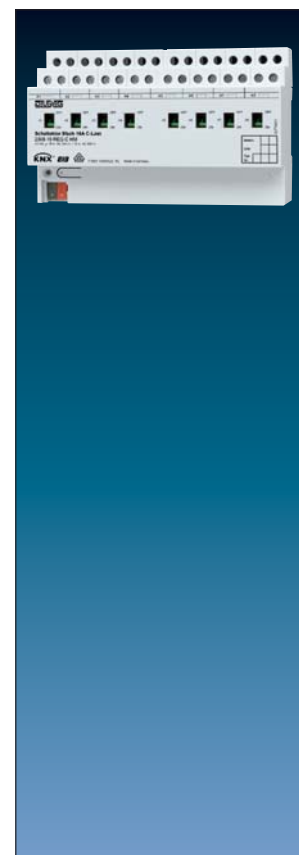
**Technical data**

Rated voltage KNX:	DC 21 ... 32 V SELV	Mounting width:	144 mm (8 rail units)
Wiring, KNX:	KNX bus connection block	Wiring, outputs:	screw terminals
Power consumption KNX:	typical 240 mW	single wire:	0.5 ... 4 mm ²
Power loss:	max. 8 W	stranded without ferrule:	0.5 ... 4 mm ²
Ambient temperature:	-5 ... +45 °C	stranded with ferrule:	0.5 ... 2.5 mm ²
Storage/transport temperature:	-25 ... +70 °C		

Current detection (sine)

Mains frequency:	50 / 60 Hz	Measuring range:	0.25 ... 16 A
Accuracy (≤ 1 A):	± 100 mA	Accuracy (> 1 A):	± 8 % of curr. val.

Switching outputs

Contact type:	floating relay contacts (μ contact)
Switching voltage AC:	AC 250 / 400 V
Switching current 230 V AC1:	16 A
Switching current 230 V AC3:	10 A
Switching current 400 V AC1:	10 A
Switching current 400 V AC3:	6 A
Fluorescent lamps:	16 AX
ohmic load:	3680 W
capacitive load:	16 A / 200 μ F
Switching voltage DC:	DC 12 ... 24 V
Switching current DC:	16 A
Min. switching current:	100 mA
Switch-on current 150 μ s:	600 A
Switch-on current 600 μ s:	300 A

Lamp loads

Incandescent lamps	
HV halogen lamps:	3680 W
LV halogen lamps with	
conventional transformer:	2000 VA
TRONIC transformer:	2500 W
Fluorescent lamps T5/T8	
non-compensated:	3680 W
parallel compensated:	2500 W / 200 μ F
lead-lag circuit:	3680 W / 200 μ F
Compact fluorescent lamps	
non-compensated:	3680 W
parallel compensated:	2500 W / 200 μ F
Mercury vapour lamps	
non-compensated:	3680 W
parallel compensated:	3680 W / 200 μ F

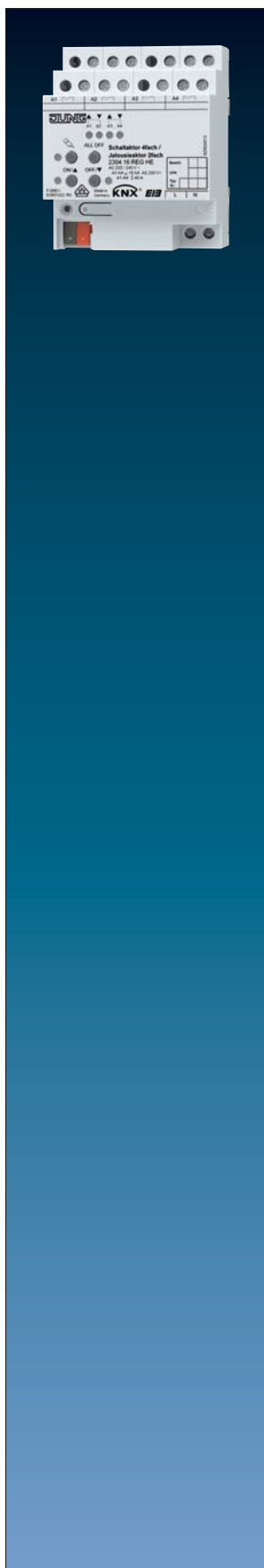

Ref.-no.

Switch / blinds actuator, 4/2-gang

Rail mounting device, 4 rail units

Switch actuator: max. 4-gang

Blind actuator: max. 2-gang

Max. 2-gang switch actuator/1-gang blind actuator in combination

with manual electronic operation and LED status indication

Only with the ETS 3.0d version or later versions the full functionality will be available.

ETS product family: Output

Product type: Binary output

2304.16 REGHE**Intended use**

- Switching of AC 230 V electrical loads with floating contacts
- Switching of electrically-driven Venetian blinds, shutters, awnings and similar hangings
- Mounting on DIN rail in small distributors

Product characteristics

- Outputs can be operated manually, construction site mode
- Feedback in manual mode and in bus mode
- Light scene function
- Disabling of individual outputs manually or via bus

Characteristics switch operation

- Operation as NO or NC contacts
- Logic and restraint function
- Feedback function
- Central switching function with centralized feedback
- Time functions: switch-on delay, switch-off delay, staircase lighting timer with run-on time

Characteristics blinds operation

- Suitable for 230 V AC motors
- Hanging position directly controllable
- Slat position directly controllable
- Feedback of movement status, blind/shutter position and slat position
- Forced position through higher-level controller
- Safety function: 3 independent wind alarms, rain alarm, frost alarm
- Sun protection function

The total current of two adjacent outputs must not exceed 20 A.

Technical data ref.-no. 2304.16 REGHE**Power supply**

Rated voltage:	AC 230/240 V ~, 50/60 Hz
Power loss:	max. 2 W
Ambient temperature:	-15 ... +45 °C
Storage/transport temperature:	-25 ... +70 °C

Outputs

Contact type:	floating relay contacts (μ contact)
Switch type:	make contact
Switching voltage:	AC 250 V ~
Switching current AC1 ($\cos \varphi > 0.8$):	16 A
Fluorescent lamps:	16 AX
Current carrying capacity	
Neighbouring outputs:	Σ 20 A
Device:	Σ 40 A
Loads per output	
ohmic load:	3000 W
capacitive load:	16 A / 140 μ F
Motors:	1380 VA
Switch-on current 200 μ s:	max. 800 A
Switch-on current 20 ms:	max. 165 A

Lamp loads

Incandescent lamps:	3000 W
HV halogen lamps:	2500 W
LV halogen lamps with	
TRONIC transformer:	1500 W
conventional transformer:	1200 VA
Fluorescent lamps T5/T8	
non-compensated:	1000 W
parallel compensated:	1160 W / 140 μ F
lead-lag circuit:	2300 W / 140 μ F
Compact fluorescent lamps	
non-compensated:	1000 W
parallel compensated:	1160 W / 140 μ F
Mercury vapour lamps	
non-compensated:	1000 W
parallel compensated:	1160 W / 140 μ F

Wiring, power supply and load

Connection mode:	screw terminals
single wire:	0.5 ... 4 mm ²
stranded without ferrule:	0.5 ... 4 mm ²
stranded with ferrule:	0.5 ... 2.5 mm ²
Rated voltage KNX:	DC 21 ... 32 V SELV
Power consumption KNX:	typical 150 mW
Wiring, KNX:	terminal



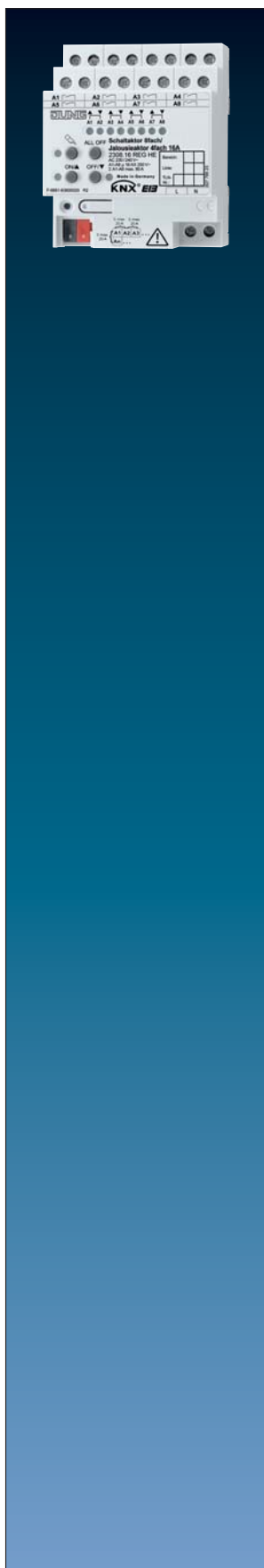

Ref.-no.

Switch / blinds actuator, 8/4-gang

Rail mounting device, 4 rail units

Switch actuator: max. 8-gang

Blind actuator: max. 4-gang

Max. 4-gang switch actuator/2-gang blind actuator in combination

with manual electronic operation and LED status indication

Only with the ETS 3.0d version or later versions the full functionality will be available.

ETS product family: Output

Product type: Binary output

2308.16 REGHE**Intended use**

- Switching of AC 230 V electrical loads with floating contacts
- Switching of electrically-driven Venetian blinds, shutters, awnings and similar hangings
- Mounting on DIN rail in small distributors

Product characteristics

- Outputs can be operated manually, construction site mode
- Feedback in manual mode and in bus mode
- Light scene function
- Disabling of individual outputs manually or via bus

Characteristics switch operation

- Operation as NO or NC contacts
- Logic and restraint function
- Feedback function
- Central switching function with centralized feedback
- Time functions: switch-on delay, switch-off delay, staircase lighting timer with run-on time

Characteristics blinds operation

- Suitable for 230 V AC motors
- Hanging position directly controllable
- Slat position directly controllable
- Feedback of movement status, blind/shutter position and slat position
- Forced position through higher-level controller
- Safety function: 3 independent wind alarms, rain alarm, frost alarm
- Sun protection function

The total current of two adjacent outputs must not exceed 20 A.

Technical data ref.-no. 2308.16 REGHE**Power supply**

Rated voltage:	AC 230/240 V ~, 50/60 Hz
Power loss:	max. 3 W
Ambient temperature:	-15 ... +45 °C
Storage/transport temperature:	-25 ... +70 °C

Outputs

Contact type:	floating relay contacts (μ contact)
Switch type:	make contact
Switching voltage:	AC 250 V ~
Switching current AC1 ($\cos \varphi > 0.8$):	16 A
Fluorescent lamps:	16 AX
Current carrying capacity	
Neighbouring outputs:	Σ 20 A
Device:	Σ 80 A
Loads per output	
ohmic load:	3000 W
capacitive load:	16 A / 140 μ F
Motors:	1380 VA
Switch-on current 200 μ s:	max. 800 A
Switch-on current 20 ms:	max. 165 A

Lamp loads

Incandescent lamps:	3000 W
HV halogen lamps:	2500 W
LV halogen lamps with	
TRONIC transformer:	1500 W
conventional transformer:	1200 VA
Fluorescent lamps T5/T8	
non-compensated:	1000 W
parallel compensated:	1160 W / 140 μ F
lead-lag circuit:	2300 W / 140 μ F
Compact fluorescent lamps	
non-compensated:	1000 W
parallel compensated:	1160 W / 140 μ F
Mercury vapour lamps	
non-compensated:	1000 W
parallel compensated:	1160 W / 140 μ F

Wiring, power supply and load

Connection mode:	screw terminals
single wire:	0.5 ... 4 mm ²
stranded without ferrule:	0.5 ... 4 mm ²
stranded with ferrule:	0.5 ... 2.5 mm ²
Rated voltage KNX:	DC 21 ... 32 V SELV
Power consumption KNX:	typical 150 mW
Wiring, KNX:	terminal



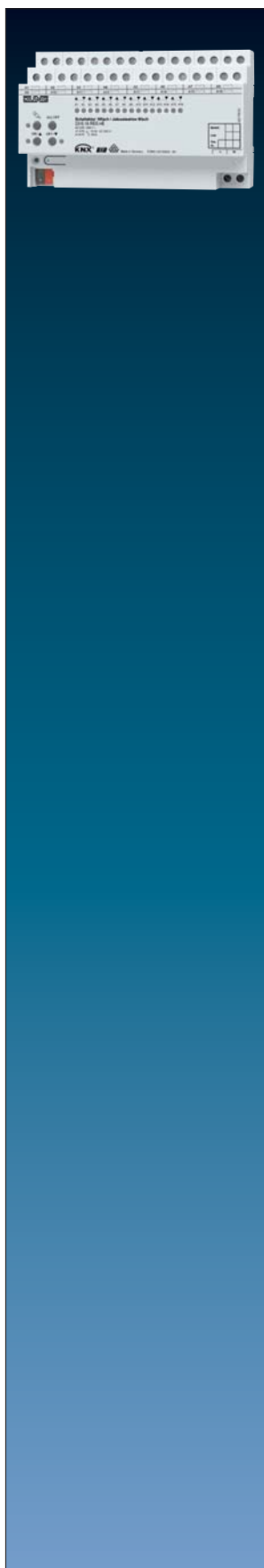

Ref.-no.

Switch / blinds actuator, 16/8-gang

Rail mounting device, 8 rail units

Switch actuator: max. 16-gang

Blind actuator: max. 8-gang

Max. 6-gang switch actuator/5-gang blind actuator in combination with manual electronic operation and LED status indication

Only with the ETS 3.0d version or later versions the full functionality will be available.

ETS product family: Output

Product type: Binary output

2316.16 REGHE**Intended use**

- Switching of AC 230 V electrical loads with floating contacts
- Switching of electrically-driven Venetian blinds, shutters, awnings and similar hangings
- Mounting on DIN rail in small distributors

Product characteristics

- Outputs can be operated manually, construction site mode
- Feedback in manual mode and in bus mode
- Light scene function
- Disabling of individual outputs manually or via bus

Characteristics switch operation

- Operation as NO or NC contacts
- Logic and restraint function
- Feedback function
- Central switching function with centralized feedback
- Time functions: switch-on delay, switch-off delay, staircase lighting timer with run-on time

Characteristics blinds operation

- Suitable for 230 V AC motors
- Hanging position directly controllable
- Slat position directly controllable
- Feedback of movement status, blind/shutter position and slat position
- Forced position through higher-level controller
- Safety function: 3 independent wind alarms, rain alarm, frost alarm
- Sun protection function

The total current of two adjacent outputs must not exceed 20 A.

Technical data ref.-no. 2316.16 REGHE**Power supply**

Rated voltage:	AC 230/240 V ~, 50/60 Hz
Power loss:	max. 4.5 W
Ambient temperature:	-15 ... +45 °C
Storage/transport temperature:	-25 ... +70 °C

Outputs

Contact type:	floating relay contacts (μ contact)
Switch type:	make contact
Switching voltage:	AC 250 V ~
Switching current AC1 ($\cos \varphi > 0.8$):	16 A
Fluorescent lamps:	16 AX
Current carrying capacity	
Neighbouring outputs:	Σ 20 A
Device:	Σ 160 A
Loads per output	
ohmic load:	3000 W
capacitive load:	16 A / 140 μ F
Motors:	1380 VA
Switch-on current 200 μ s:	max. 800 A
Switch-on current 20 ms:	max. 165 A

Lamp loads

Incandescent lamps:	3000 W
HV halogen lamps:	2500 W
LV halogen lamps with	
TRONIC transformer:	1500 W
conventional transformer:	1200 VA
Fluorescent lamps T5/T8	
non-compensated:	1000 W
parallel compensated:	1160 W / 140 μ F
lead-lag circuit:	2300 W / 140 μ F
Compact fluorescent lamps	
non-compensated:	1000 W
parallel compensated:	1160 W / 140 μ F
Mercury vapour lamps	
non-compensated:	1000 W
parallel compensated:	1160 W / 140 μ F

Wiring, power supply and load

Connection mode:	screw terminals
single wire:	0.5 ... 4 mm ²
stranded without ferrule:	0.5 ... 4 mm ²
stranded with ferrule:	0.5 ... 2.5 mm ²
Rated voltage KNX:	DC 21 ... 32 V SELV
Power consumption KNX:	typical 150 mW
Wiring, KNX:	terminal



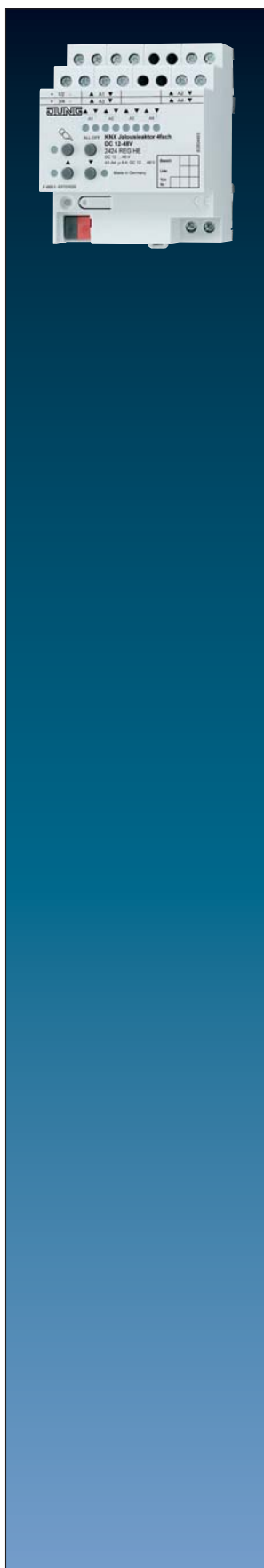

Ref.-no.

Blinds actuator, 4-gang DC 12 – 48 V

Rail mounting device, 4 rail units

with manual electronic operation and LED status indication

Only with the ETS 3.0d version or later versions the full functionality will be available.

ETS product family: Shutter

Product type: Shutter

2424 REGHE**Intended use**

- Switching of electrically driven venetian blinds, rolling shutters, awnings and similar hangings for DC 12 ... 48 V extra-low voltage.
- Mounting on DIN rail in distribution boxes

Product characteristics

- Outputs can be operated manually, construction site mode
- Suitable for 12 ... 48 V DC motors
- Automatic operation time detection possible with 230 V drives
- Hanging position directly controllable
- Slat position directly controllable
- Light scene function
- Acknowledgement of movement state, hanging position and slat position in bus and manual operation.
- Top and bottom forced position via higher-level controller
- Safety function: 3 independent wind alarms, rain alarm, frost alarm
- Sun protection function
- Integration into building temperature management is possible
- Disabling of individual outputs manually or via bus

Technical data

Outputs:	4 independent channels for one blind/shutter motor each
Contact type:	floating make contact
Switching voltage DC:	DC 12 ... 48 V
Breaking capacity DC 12 V:	6 A
Breaking capacity DC 24 V:	6 A
Breaking capacity DC 48 V:	3 A
Min. switching current DC:	100 mA
Wiring:	screw terminals
single wire:	0.5 ... 4 mm ²
stranded without ferrule:	0.5 ... 4 mm ²
stranded with ferrule:	0.5 ... 2.5 mm ²

Ref.-no.

Blinds actuator, 2-gang AC 230 V, 1-gang DC 12 – 48 V

Rail mounting device, 4 rail units
with manual electronic operation and LED status indication
Only with the ETS 3.0d version or later versions the full functionality will be available.
ETS product family: Shutter
Product type: Shutter

2502 REGHE

Intended use

- Switching of electrically driven venetian blinds, rolling shutters, awnings and similar hangings for AC 230 V mains voltage or DC 12 ... 48 V extra-low voltage.
- Mounting on DIN rail in distribution boxes

Product characteristics

- Outputs can be operated manually, construction site mode
- Suitable for 230 V AC motors and 12 ... 48 V DC motors
- Automatic operation time detection possible with 230 V drives
- Hanging position directly controllable
- Slat position directly controllable
- Light scene function
- Acknowledgement of movement state, hanging position and slat position in bus and manual operation.
- Top and bottom forced position via higher-level controller
- Safety function: 3 independent wind alarms, rain alarm, frost alarm
- Sun protection function
- Integration into building temperature management is possible
- Disabling of individual outputs manually or via bus

Technical data

Outputs:	2 channels AC 230 V, 1 channel DC 12 ... 48 V
Contact type:	floating make contact
Power supply mains:	AC 110 V (-10 %) ... 240 V (+10 %) 50/60 Hz
Wiring:	screw terminals
single wire:	0.5 ... 4 mm ²
stranded without ferrule:	0.5 ... 4 mm ²
stranded with ferrule:	0.5 ... 2.5 mm ²
Breaking capacity AC1:	6 A (230 V)
Switching current DC 12/24 V:	6 A
Switching current DC 48 V:	3 A
Max. blind/shutter running time:	20 min
Ambient temperature:	-5 ... +45 °C
Storing temperature:	-25 ... +70 °C

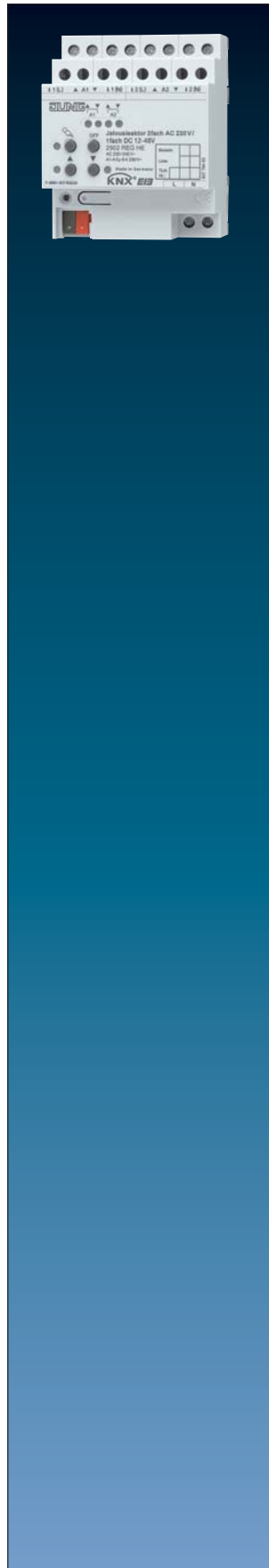

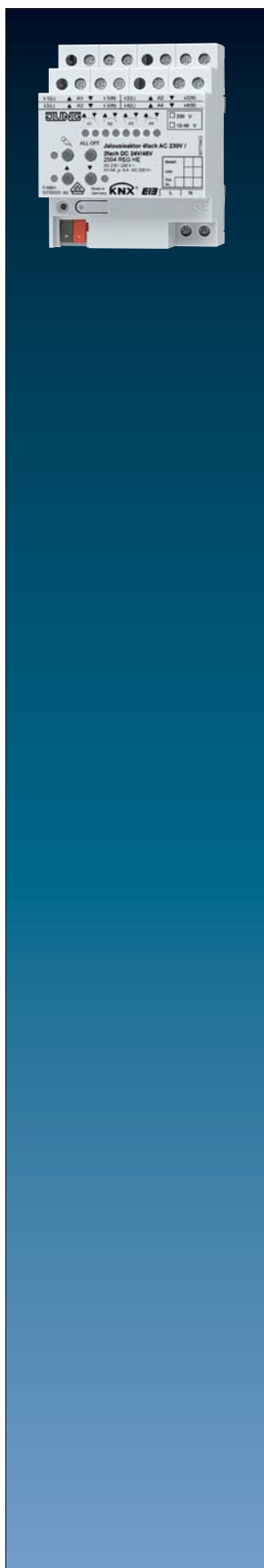

Ref.-no.

Blinds actuator, 4-gang AC 230 V, 2-gang DC 12 – 48 V

Rail mounting device, 4 rail units

with manual electronic operation and LED status indication

Only with the ETS 3.0d version or later versions the full functionality will be available.

ETS product family: Shutter

Product type: Shutter

2504 REGHE**Intended use**

- Switching of electrically driven venetian blinds, rolling shutters, awnings and similar hangings for AC 230 V mains voltage or DC 12 ... 48 V extra-low voltage.
- Mounting on DIN rail in distribution boxes

Product characteristics

- Outputs can be operated manually, construction site mode
- Suitable for 230 V AC motors and 12 ... 48 V DC motors
- Automatic operation time detection possible with 230 V drives
- Hanging position directly controllable
- Slat position directly controllable
- Light scene function
- Acknowledgement of movement state, hanging position and slat position in bus and manual operation.
- Top and bottom forced position via higher-level controller
- Safety function: 3 independent wind alarms, rain alarm, frost alarm
- Sun protection function
- Integration into building temperature management is possible
- Disabling of individual outputs manually or via bus

Technical data

Outputs:	4 channels AC 230 V, 2 channels DC 12 ... 48 V
Contact type:	floating make contact
Power supply mains:	AC 110 V (–10 %) ... 240 V (+10 %) 50/60 Hz
Wiring:	screw terminals
single wire:	0.5 ... 4 mm ²
stranded without ferrule:	0.5 ... 4 mm ²
stranded with ferrule:	0.5 ... 2.5 mm ²
Breaking capacity AC1:	6 A (230 V)
Switching current DC 12/24 V:	6 A
Switching current DC 48 V:	3 A
Max. blind/shutter running time:	20 min
Ambient temperature:	–5 ... +45 °C
Storing temperature:	–25 ... +70 °C

Ref.-no.

Blinds actuator, 8-gang AC 230 V, 4-gang DC 12 – 48 V

Rail mounting device, 8 rail units
 with manual electronic operation and LED status indication
 Only with the ETS 3.0d version or later versions the full functionality will be available.
 ETS product family: Shutter
 Product type: Shutter

2508 REGHE**Intended use**

- Switching of electrically driven venetian blinds, rolling shutters, awnings and similar hangings for AC 230 V mains voltage or DC 12 ... 48 V extra-low voltage.
- Mounting on DIN rail in distribution boxes

Product characteristics

- Outputs can be operated manually, construction site mode
- Suitable for 230 V AC motors and 12 ... 48 V DC motors
- Automatic operation time detection possible with 230 V drives
- Hanging position directly controllable
- Slat position directly controllable
- Light scene function
- Acknowledgement of movement state, hanging position and slat position in bus and manual operation.
- Top and bottom forced position via higher-level controller
- Safety function: 3 independent wind alarms, rain alarm, frost alarm
- Sun protection function
- Integration into building temperature management is possible
- Disabling of individual outputs manually or via bus

Technical data

Outputs:	8 channels AC 230 V, 4 channels DC 12 ... 48 V
Contact type:	floating make contact
Power supply mains:	AC 110 V (-10 %) ... 240 V (+10 %) 50/60 Hz
Wiring:	screw terminals
single wire:	0.5 ... 4 mm ²
stranded without ferrule:	0.5 ... 4 mm ²
stranded with ferrule:	0.5 ... 2.5 mm ²
Breaking capacity AC1:	6 A (230 V)
Switching current DC 12/24 V:	6 A
Switching current DC 48 V:	3 A
Max. blind/shutter running time:	20 min
Ambient temperature:	-5 ... +45 °C
Storing temperature:	-25 ... +70 °C



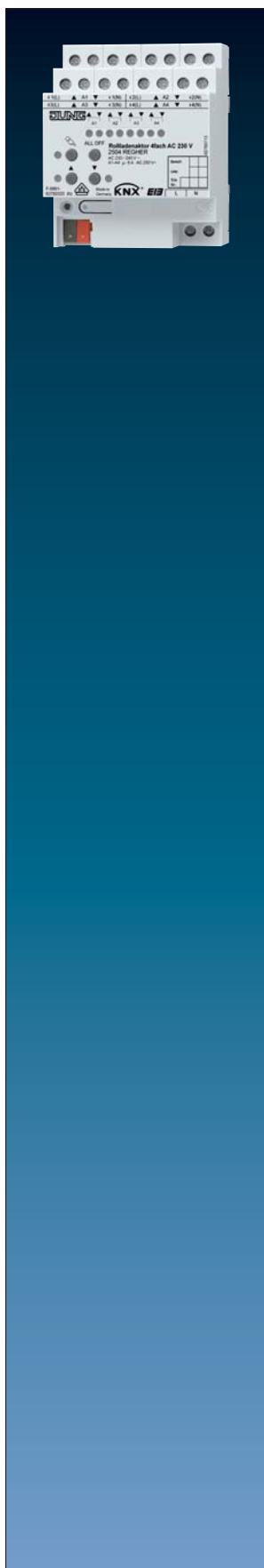

Ref.-no.

Shutter actuator 4-gang AC 230 V

Rail mounting device, 4 rail units
with manual electronic operation and LED status indication
ETS product family: Shutter
Product type: Shutter

2504 REGHER**Intended use**

- Switching of electrically driven, rolling shutters, awnings and similar hangings for AC 230 V mains voltage
- Mounting on DIN rail in distribution boxes

Product characteristics

- Outputs can be operated manually, construction site mode
- Suitable for 230 V AC motors
- Position directly controllable
- Acknowledgement of movement state
- Safety function: 3 independent wind alarms, rain alarm, frost alarm

Technical data

Outputs:	4 channels AC 230 V, 2 channels DC 12 ... 48 V
Contact type:	floating make contact
Power supply mains:	AC 110 V (-10 %) ... 240 V (+10 %) 50/60 Hz
Wiring:	screw terminals
single wire:	0.5 ... 4 mm ²
stranded without ferrule:	0.5 ... 4 mm ²
stranded with ferrule:	0.5 ... 2.5 mm ²
Breaking capacity AC1:	6 A (230 V)
Switching current DC 12/24 V:	6 A
Switching current DC 48 V:	3 A
Max. shutter running time:	20 min
Ambient temperature:	-5 ... +45 °C
Storing temperature:	-25 ... +70 °C

Ref.-no.

Universal dimming actuator / speed regulator, 1-gang

1 x 500 W

Rail mounting device, 4 rail units

ETS product family: Illumination

Product type: Dimmer

3801 REGHE**Intended use**

- Switching and dimming of HV-incandescent lamps, 230 V halogen lamps and LV-halogen lamps with inductive or electronic transformers
- Speed controller for regulating the speed of 1-phase motors like induction-, shaded pole-, or universal motors
- Installation on DIN rail according to EN 60715 in distribution boards

Product characteristics

- Automatic or manual selection of the appropriate dimming principle
- Open loop, short circuit and over temperature safe
- Short circuit message
- Manual operation of outputs
- Acknowledges of switching and dimming value
- Switch on and switch off behaviour can be parameterised
- Switch on delay, switch off delay and staircase function
- Light scene operation
- Outputs can be blocked manually or via bus
- Outputs status LED
- Operating hour counter
- Speed controller for regulating the speed of 1-phase motors like induction-, shaded pole- or universal-motors
- At mains failure for more than 5 sec. the device switches off
- Power extension with JUNG power amplifiers. (The max. brightness level of the output must be set to 90 %.)

Technical data

Rated voltage: AC 110 ... 230 V ~, 50/60 Hz; max. 4.5 W

Ambient temperature: -5 ... +45 °C

Storage/transport temperature: -25 ... +70 °C

Contact type: 8, MOSFET

Motor loads

Motor switching current: 2.3 A

Lamp loads

Connected load, 230 V per output

Incandescent lamps: 20 ... 500 W

HV halogen lamps: 20 ... 500 W

conventional transformers: 20 ... 500 VA

TRONIC transformers: 20 ... 500 W

ohmic-inductive: 20 ... 500 VA

ohmic-capacitive: 20 ... 500 W

capacitive-inductive: not permitted

Wiring: screw terminals

single wire: 0.5 ... 4 mm²stranded without ferrule: 0.5 ... 4 mm²stranded with ferrule: 0.5 ... 2.5 mm²

Connected load, 110 V per output

Incandescent lamps: 20 ... 250 W

HV halogen lamps: 20 ... 250 W

conventional transformers: 20 ... 250 VA

TRONIC transformers: 20 ... 250 W

ohmic-inductive: 20 ... 250 VA

ohmic-capacitive: 20 ... 250 W

capacitive-inductive: not permitted

Do not connect any electronic lamps, e.g. switchable or dimmable compact fluorescent lamps or LED lamps. Device can be damaged.

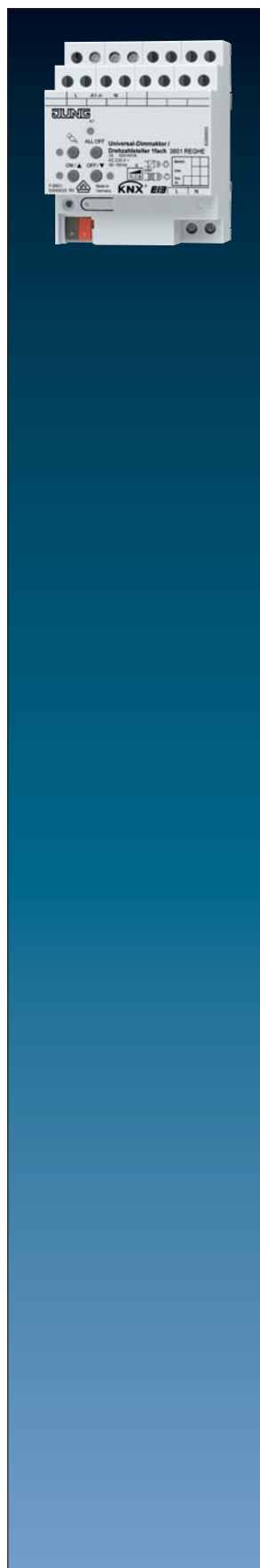

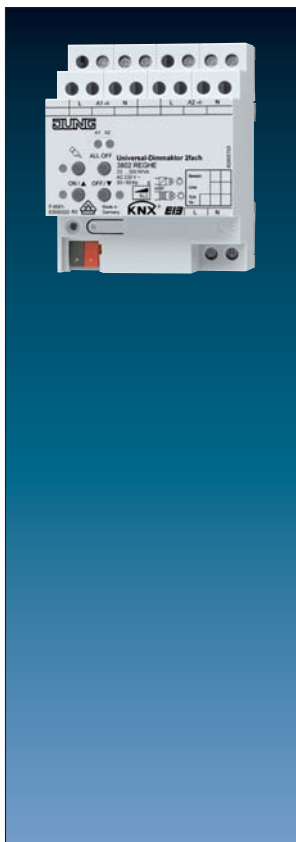

Ref.-no.

Universal dimming actuator, 2-gang

2 x 300 W
 Rail mounting device, 4 rail units
 ETS product family: Illumination
 Product type: Dimmer

3802 REGHE

Intended use

- Switching and dimming of HV-incandescent lamps, 230 V halogen lamps and LV-halogen lamps with inductive or electronic transformers
- Installation on DIN rail according to EN 60715 in distribution boards

Product characteristics

- Automatic or manual selection of the appropriate dimming principle
- Open loop, short circuit and over temperature safe
- Short circuit message
- Manual operation of outputs
- Acknowledges of switching and dimming value
- Switch on and switch off behaviour can be parameterised
- Switch on delay, switch off delay and staircase function
- Light scene operation
- Outputs can be blocked manually or via bus
- Outputs status LED
- Operating hour counter
- At mains failure for more than 5 sec. the device switches off
- Power extension with JUNG power amplifiers. (The max. brightness level of the output must be set to 90 %.)

Technical data

Rated voltage: AC 110 ... 230 V ~, 50/60 Hz
 max. 6.5 W
 Ambient temperature: -5 ... +45 °C
 Storage/transport temperature: -25 ... +70 °C
 Contact type: ε, MOSFET

Lamp loads

Connected load, 230 V per output		Connected load, 110 V per output	
Incandescent lamps:	20 ... 300 W	Incandescent lamps:	20 ... 150 W
HV halogen lamps:	20 ... 300 W	HV halogen lamps:	20 ... 150 W
conventional transformers:	20 ... 300 VA	conventional transformers:	20 ... 150 VA
TRONIC transformers:	20 ... 300 W	TRONIC transformers:	20 ... 150 W
ohmic-inductive:	20 ... 300 VA	ohmic-inductive:	20 ... 150 VA
ohmic-capacitive:	20 ... 300 W	ohmic-capacitive:	20 ... 150 W
capacitive-inductive:	not permitted	capacitive-inductive:	not permitted
Wiring:	screw terminals		
single wire:	0.5 ... 4 mm ²		
stranded without ferrule:	0.5 ... 4 mm ²		
stranded with ferrule:	0.5 ... 2.5 mm ²		

Do not connect any electronic lamps, e.g. switchable or dimmable compact fluorescent lamps or LED lamps. Device can be damaged.

stranded
 stranded

Ref.-no.

Universal dimming actuator, 4-gang

Rail mounting device, 8 rail units
 ETS product family: Illumination
 Product type: Dimmer

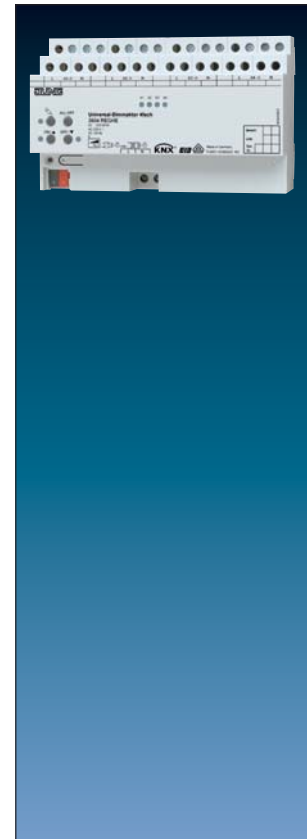
3804 REGHE**Intended use**

- Switching and dimming of HV-incandescent lamps, 230 V halogen lamps and LV-halogen lamps with inductive or electronic transformers
- The four dimmer outputs can be used in parallel, 4 x 250 VA or 1 x 950 VA
- Installation on DIN rail according to EN 60715 in distribution boards

Product characteristics

- Automatic or manual selection of the appropriate dimming principle
- Open loop, short circuit and over temperature safe
- Short circuit message
- Manual operation of outputs
- Acknowledges of switching and dimming value
- Switch on and switch off behaviour can be parameterised
- Switch on delay, switch off delay and staircase function
- Light scene operation
- Outputs can be blocked manually or via bus
- Outputs status LED
- Operating hour counter
- At mains failure for more than 5 sec. the device switches off
- Increasing of the power output by putting channels in parallel, max. 950 VA
- Power extension with JUNG power amplifiers. (The max. brightness level of the output must be set to 90 %.)

Technical data

Rated voltage:	AC 110 ... 230 V ~, 50/60 Hz
	max. 8.5 W
Ambient temperature:	-5 ... +45 °C
Storage/transport temperature:	-25 ... +70 °C
Contact type:	ε, MOSFET

Lamp loads

Connected load, 230 V per output

Incandescent lamps:	20 ... 250 W
HV halogen lamps:	20 ... 250 W
conventional transformers:	20 ... 250 VA
TRONIC transformers:	20 ... 250 W
ohmic-inductive:	20 ... 250 VA
ohmic-capacitive:	20 ... 250 W
capacitive-inductive:	not permitted

Wiring: screw terminals

single wire:	0.5 ... 4 mm ²
stranded without ferrule:	0.5 ... 4 mm ²
stranded with ferrule:	0.5 ... 2.5 mm ²

Connected load, 110 V per output

Incandescent lamps:	20 ... 120 W
HV halogen lamps:	20 ... 120 W
conventional transformers:	20 ... 120 VA
TRONIC transformers:	20 ... 120 W
ohmic-inductive:	20 ... 120 VA
ohmic-capacitive:	20 ... 120 W
capacitive-inductive:	not permitted

Do not connect any electronic lamps, e.g. switchable or dimmable compact fluorescent lamps or LED lamps. Device can be damaged.

stranded
 stranded

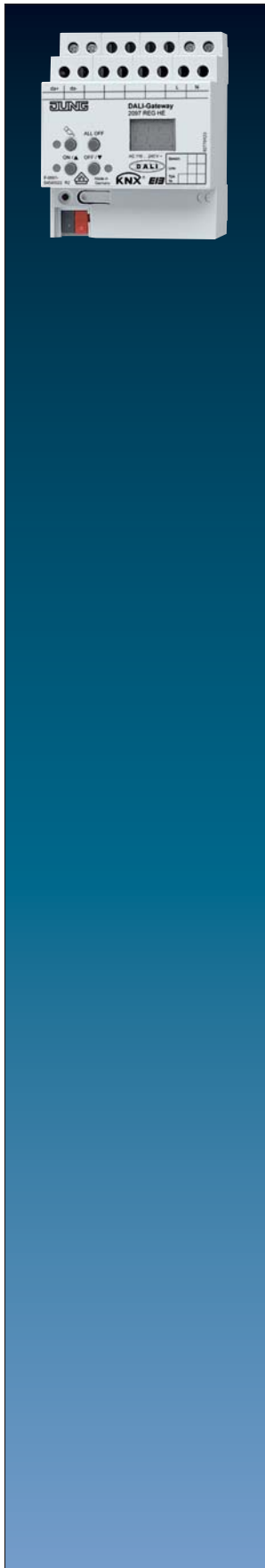

Ref.-no.

DALI gateway

Rail mounting device, 4 rail units
with manual electronic operation and LED status indication
ETS product family: Illumination
Product type: Dimmer

2097 REGHE

Intended use

- Controlling of luminaires and other applications with DALI operating device in KNX installations e.g. electronic ballast
- Installation on DIN rail according to EN 60715 in distribution boxes

Product characteristics

- Control of up to 64 DALI devices in up to 32 groups
- 16 light scenes
- Read out DALI device state via KNX, e.g. brightness or luminaire error, short circuit or supply voltage
- Manual operation of the DALI groups
- Forced position operation
- Feedback of switching state and brightness value in bus and manual mode
- Central switching function
- Disabling function for each DALI group
- Separate ON and OFF delay
- Staircase lighting timer with run-on time
- DALI commissioning with ETS plug-in
- Short circuit protection
- Surge protection
- Overload protection
- An individual DALI device can be exchanged during operation without software.

Technical data

Rated voltage:	AC 110 ... 240 V ~, 50/60 Hz
Power loss:	max. 3 W
Ambient temperature:	-5 ... +45 °C
Storage/transport temperature:	-25 ... +70 °C
Rated voltage DALI:	DC 16 V
Number of DALI devices:	max. 64
DALI transmission rate:	1.2 kbit/s
Mounting width:	72 mm (4 rail units)
Wiring, power supply and DALI:	screw terminals
single wire:	0.5 ... 4 mm ²
stranded without ferrule:	0.5 ... 4 mm ²
stranded with ferrule:	0.5 ... 2.5 mm ²
Rated voltage KNX:	DC 21 ... 32 V SELV
Power consumption KNX:	typical 150 mW
Wiring, KNX:	terminal

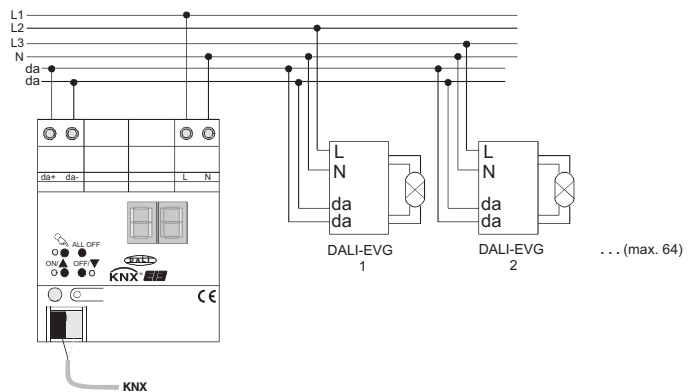

Ref.-no.

DALI transformer for LV halogen lamps

(no KNX device)

D SNT 105**Intended use**

- Power supply for LV halogen lamps
- Switching and brightness adjustment is performed with DALI control units or push-buttons
- Installation in false ceilings or surface mounting

Product characteristics

- Open loop proof
- Electronic short-circuit protection
- Electronic overload protection
- Electronic overtemperature protection
- Suitable for emergency current installation

Technical data

Rated capacity:	35 – 105 W
Rated voltage:	AC 230/240 V ~, 50/60 Hz
Output voltage:	11.5 V eff. ~ 40 kHz
Short-circuit protection:	electronic protection without fuse
Output cable length:	max. 2 m
Dimensions:	170 x 44 x 34 mm
Ambient temperature:	max. 50 °C
Terminals:	screw terminals
primary:	0.5 ... 1.5 mm ²
secondary:	0.75 ... 2.5 mm ²





Ref.-no.

Control unit 1 – 10 V, 3-gang

Rail mounting device, 4 rail units

ETS product family: Illumination

Product type: Dimmer

2193 REG**Intended use**

- Switching and brightness setting for lamps with operating devices with 1 – 10 V interface
- Mounting on DIN rail according to EN 60715 in distribution boxes

Product characteristics

- Relay switch contact for switching the connected loads
- Manual operation of the relay independently of the bus
- Various L1, L2 and L3 external conductors can be connected.
- No additional power supply necessary
- Feedback of switching state and brightness value (set T-flag in brightness value object)
- Switch position display
- Switch-on and dimming behaviour can be set with soft-ON, soft-OFF function
- Time dimmer can be set
- Time functions: switch-on delay, switch-off delay, staircase lighting timer with run-on time
- Integration into light scenes
- Blocking operation (parameterized brightness value on start and end of blocking)

Technical data

Rated voltage KNX:	DC 21 ... 32 V SELV
Wiring, KNX:	KNX bus connection block
Power consumption KNX:	max. 240 mW
Ambient temperature:	-5 ... +45 °C
Storage/transport temperature:	-25 ... +70 °C

Control outputs

Control voltage:	1 ... 10 V
Control current per output:	max. 100 mA
Cable length:	max. 500 m (0.5 mm ²)

Switching outputs

Contact type:	floating relay contacts (μ contact)
Switching voltage AC:	AC 250 / 400 V
Switching current 230 V AC1:	16 A
Switching current 230 V AC3:	10 A
Switching current 400 V AC1:	10 A
Switching current 400 V AC3:	6 A
Fluorescent lamps:	10 AX
Switching voltage DC:	DC 12 ... 24 V
Switching current DC:	16 A
Min. switching current:	100 mA
Switch-on current 150 μs:	400 A
Switch-on current 600 μs:	200 A
ohmic load:	3680 W
capacitive load:	10 A / 140 μF

Wiring, outputs:	screw terminals
	single wire: 0.5 ... 4 mm ²
	stranded without ferrule: 0.5 ... 4 mm ²
	stranded with ferrule: 0.5 ... 2.5 mm ²
Mounting width:	72 mm (4 rail units)

Lamp loads

Incandescent lamps:	2500 W
HV halogen lamps:	2500 W
LV halogen lamps with conventional transformer:	1200 VA
TRONIC transformer:	1500 W
Fluorescent lamps T5/T8 non-compensated:	2500 W
parallel compensated:	1300 W / 140 μF
lead-lag circuit:	2300 W / 140 μF
Compact fluorescent lamps non-compensated:	2500 W
parallel compensated:	1300 W / 140 μF
Mercury vapour lamps non-compensated:	2000 W
parallel compensated:	2000 W / 140 μF

Ref.-no.

Heating actuator, 6-gang

Rail mounting device, 4 rail units

6 outputs "TRIAC"

ETS product family: Heating, A/C, Ventilation

Product type: Valve

2136 REG HZ**Intended use**

- Switching of electrothermal actuators for heaters or cooling ceilings
- Installation in distribution boxes on DIN rail according to DIN EN 60715

Product characteristics

- Switching or PWM operation mode
- Actuators with characteristics opened or closed without power
- Overload-protected, short circuit-protected
- Protection against jamming valves
- Forced position
- Various setpoints for forced position or emergency operation in case of bus failure for summer or winter
- Cyclical monitoring of the input signals can be parameterized
- Feedback via bus, e.g. in case of mains failure, overload or sensor failure

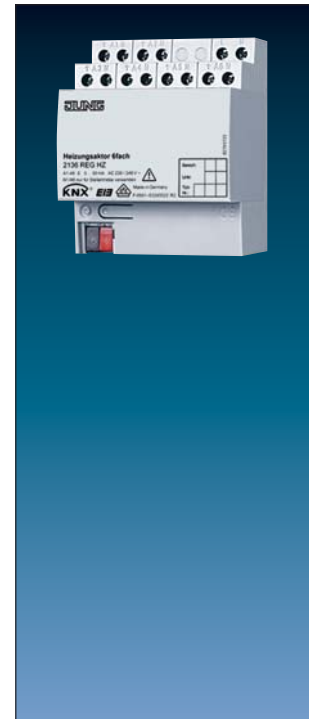
**Technical data**

Rated voltage:	AC 230/240 V ~, 50/60 Hz
Power loss:	approx. 2 W
Ambient temperature:	-5 ... +45 °C
Storage/transport temperature:	-25 ... +75 °C

Heating outputs

Contact type:	semiconductor (triac), Ⓢ
Switching voltage:	AC 230/240 V ~
Switching current:	5 ... 50 mA
Switch-on current:	max. 1.5 A (2 s)
Number of drives per output:	max. 4

Mounting width:	72 mm (4 rail units)
Rated voltage KNX:	DC 21 ... 32 V SELV
Power consumption KNX:	max. 125 mW
Wiring, KNX:	terminal

Wiring, mains and outputs:	screw terminals
single wire:	0.5 ... 4 mm ²
stranded without ferrule:	0.5 ... 4 mm ²
stranded with ferrule:	0.5 ... 2.5 mm ²

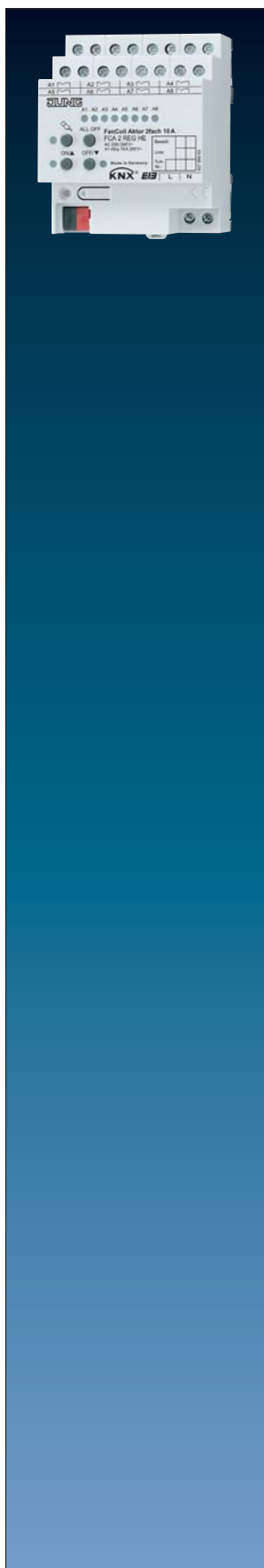

Ref.-no.

Fan coil actuator 2-gang

Rail mounting device, 4 rail units

with manual electronic operation and LED status indication

Only with the ETS 3.0d version or later versions the full functionality will be available.

ETS product family: Heating, A/C, Ventilation

Product type: Fan-coil

FCA 2 REGHE**Product characteristics**

- Connection of a fan coil unit with up to 6 fan stages or connection of two fan coil units with up to 3 fan stages respectively
- Manual output control, provisional operation
- Control options for heating, cooling or combined heating/cooling operation
- 2-pipe or 4-pipe operation
- Individual or hierarchical switching of fan stages
- Feedback
- Output state indication
- Disable function for each channel
- Not used fan outputs can be used as regular switching outputs

Modes of operation

- Bus operation: operation via touch sensors or room controller
- Temporary manual control: manual operation locally with keypad, automatic return to bus operation
- Permanent manual control mode: only manual operation locally on device

Technical data ref.-no. FCA 2 REGHE

KNX supply:	DC 21 ... 32 V SELV
Power consumption KNX:	typical 150 mW
Rated voltage:	AC 230/240 V ~, 50/60 Hz
Power loss:	max. 3 W
Ambient temperature:	-5 ... +45 °C
Storing temperature:	-25 ... +70 °C
Wiring, KNX:	bus connection block
Wiring, mains and outputs:	screw terminals
single wire:	0.5 ... 4 mm ²
stranded without ferrule:	0.5 ... 4 mm ²
stranded with ferrule:	0.5 ... 2.5 mm ²
Switch type:	make contact
Contact type:	floating relay contacts (μ contact)
Switching voltage:	AC 230/240 V ~
Breaking capacity AC1:	10 A
Breaking capacity AC3:	10 A

Switching capacities per output

ohmic load:	2300 W
capacitive load:	10 A / max. 140 μF
Motors:	1380 VA

Lamp loads

Incandescent lamps:	2300 W
HV halogen lamps:	2300 W
LV halogen lamps with	
conventional transformer:	1200 VA
TRONIC transformer:	1500 W
Fluorescent lamps	
non-compensated:	1000 W
parallel compensated:	1160 W / 140 μF
lead-lag circuit:	2300 W / 140 μF

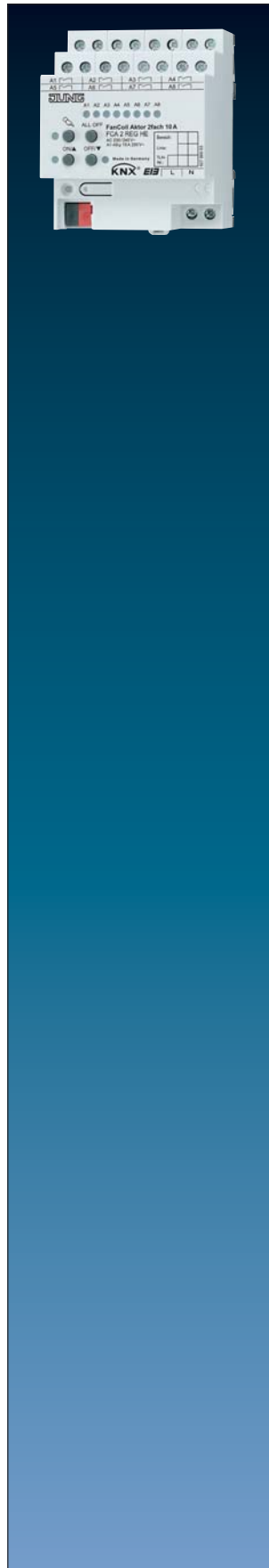

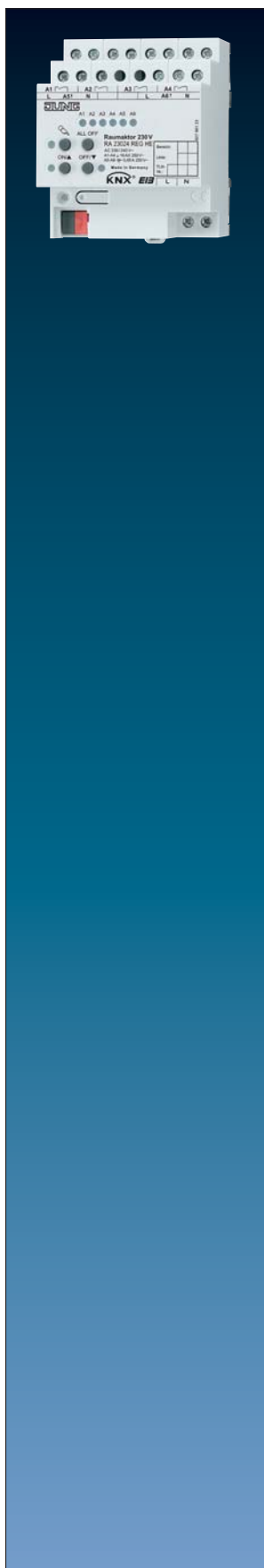

Ref.-no.

Room actuator 230 V

Rail mounting device, 4 rail units

with manual electronic operation and LED status indication

Only with the ETS 3.0d version or later versions the full functionality will be available.

ETS product family: Output

Product type: Binary output

RA 23024 REGHE**Intended use**

- Dedicated universal device for multiple applications, e.g. in a hotel guest room
- Switching of electrical consumers AC 230 V with floating contacts
- Switching of electrically operated blinds, shutters, awnings and similar curtains
- Heating outputs: electronic outputs for switching electro-thermal valve drives

Product characteristics

- Manual output control, provisional operation
- Feedback in manual control mode and in bus operation
- Scene function
- Disabling of individual outputs by hand or via the bus

Switching function

- Make-contact and break-contact operation
- Logic operation and forcing function
- Feedback function
- Central switching function with centralized feedback
- Time functions: ON-delay, OFF-delay, staircase lighting timer with pre-warning function

Blind/shutter function

- Suitable for AC motors 230 V
- Direct control of blind/shutter position
- Direct control of slat position
- Acknowledgement of movement state, blind/shutter position and slat position
- Forced-control position from primary control
- Safety function: 3 independent wind alarms, rain alarm, frost alarm
- Sun protection function

Control of valve drives 230 V

- Switching or PWM operation
- Control of valve drives with working characteristics "normally open" or "normally closed"
- Overload and short-circuit protection
- Emergency operation in the event of bus failure for summer and winter
- Protection against jamming valves
- Forced-control position

Technical data ref.-no. RA 23024 REGHE

KNX supply:	DC 21 ... 32 V SELV
Power consumption KNX:	max. 150 mW
Power supply mains:	AC 110 ... 230 V ~, 50/60 Hz
Power loss:	max. 6 W
Ambient temperature:	-5 ... +45 °C
Storing temperature:	-25 ... +70 °C
Mounting width:	72 mm (4 rail units)
Wiring, KNX:	bus connection block
Wiring, mains and outputs:	screw terminals
	single wire: 0.5 ... 4 mm ²
	stranded without ferrule: 0.5 ... 4 mm ²
	stranded with ferrule: 0.5 ... 2.5 mm ²

Heating outputs

Number:	2
Contact type:	semiconductor,
Switching voltage:	AC 230/240 V ~
Switching current:	5 ... 50 mA
Switch-on current:	max. 1.5 A (2 s)
Number of drives per output:	max. 4

Relay outputs

Number:	4 (2 channels for operating blinds)
Contact type:	floating make contact (μ contact)
Switching voltage:	AC 230/240 V ~
Breaking capacity AC1:	16 A
Breaking capacity AC3:	6 A
Breaking capacity fluorescent lamps:	16 AX

Switching capacities per output

ohmic load:	3000 W
capacitive load:	16 A / max. 140 μF
Motors:	1380 VA

Lamp loads

Incandescent lamps:	3000 W
HV halogen lamps:	2500 W
LV halogen lamps with	
TRONIC transformer:	1500 W
conventional transformer:	1200 VA
Fluorescent lamps	
non-compensated:	1000 W
parallel compensated:	1160 W / max. 140 μF
lead-lag circuit:	2300 W / max. 140 μF

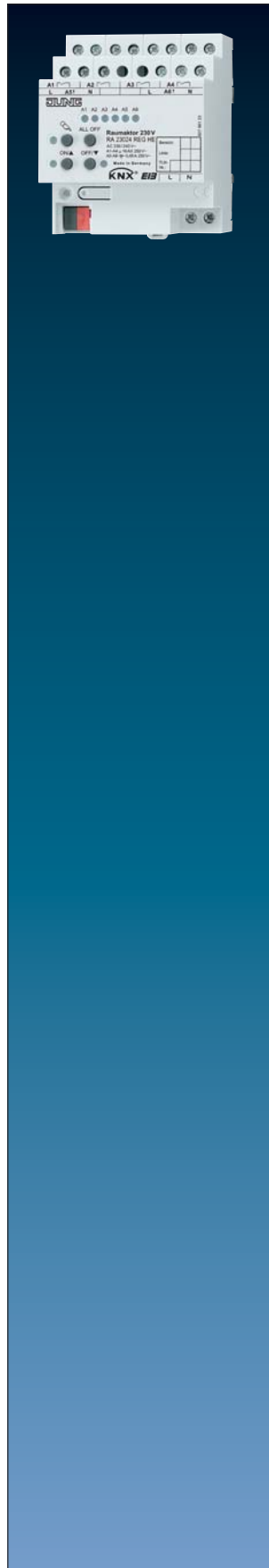

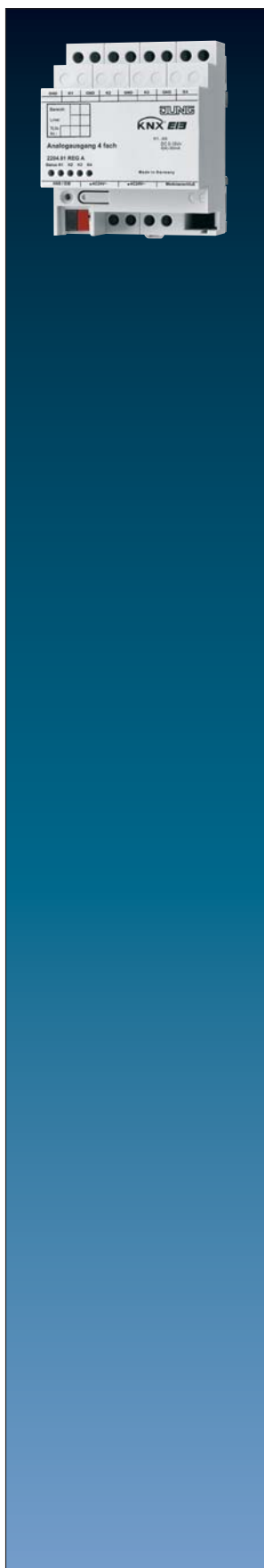

Ref.-no.

Analogue actuator, 4-gang

Rail mounting device, 4 rail units

ETS product family: Output

Product type: Analogue output 4-gang

2204.01 REGA**The analogue output needs 24 V AC for operation. The necessary power can be supplied by the power supply unit ref.-no.: WSSV 10.**

- The analogue output converts measuring data received via KNX telegrams (DPT-ID 9.0xx and 5.010) into analogue output signals.
- The analogue output signals enable heating, ventilation and air conditioning units to adapt their output values to information received from the bus and thus to take part in control processes.
Voltage signals: 0 ... 1 V DC 0 ... 10 V DC
Current signals: 0 ... 20 mA DC 4 ... 20 mA DC
- The analogue output offers four analog outputs which can be software-parameterized for one of the ranges mentioned above. Outputs not used can be deactivated.
- The output variables can be force-controlled from a coordinating control system.
- With an analogue output extension module, the number of analog outputs can be increased from 4 to 8.
- In conjunction with the "dimming" function of a sensor, both, the analogue output and also the analogue output extension module can be used as an active control unit for dimming applications.

Remarks on the hardware:

- The GND terminals must not be connected to the corresponding terminals of another device.
- The outputs of the analogue output and of the analogue output extension module must not be connected to the 1 ... 10 V interface of electronic ballasts or electronic transformers.
- All connected components must ensure safe separation from other voltages

Technical data**Power supply**

Supply voltage:	AC 24 V ~ ± 10 %
Current consumption:	max. 308 mA
Rated voltage KNX:	DC 21 ... 32 V SELV
Power consumption KNX:	typical 150 mW
Ambient temperature:	-5 ... +45 °C
Storage/transport temperature:	-25 ... +70 °C
Humidity	
Ambient/storage/transport:	max. 93 % r. h., no condensation
Mounting width:	72 mm (4 rail units)
Weight:	approx. 180 g
Terminals	
Outputs, power supply:	screw terminals
single wire:	0.5 ... 4 mm ²
stranded without ferrule:	0.5 ... 4 mm ²
stranded with ferrule:	0.5 ... 2.5 mm ²
	bus connection block
Analogue outputs	
Number:	4
Ranges:	0 ... 1 V, 0 ... 10 V, DC 0 ... 20 mA, 4 ... 20 mA, DC
Voltage signal load:	≥ 1 kW
Current signal load:	≤ 500 W
Power supply	
Analogue actuator module:	DC 24 V via system bus max. 80 mA

Ref.-no.

Analogue actuator module, 4-gang

Rail mounting device, 4 rail units

2204.01 REGAM

Extension module for analogue actuator 4-gang ref.-no.: 2204.01 REGA

Function

- The analogue actuator module extends a KNX analogue actuator 4-gang by four additional sensor outputs.
- The analogue output extension module offers four analogue outputs which can be software parameterized for one of the following ranges.
- Outputs not used can be deactivated.
Voltage signals: 0 ... 1 V DC 0 ... 10 V DC
Current signals: 0 ... 20 mA DC 4 ... 20 mA DC

Technical data**Power supply**

Supply voltage:	AC 24 V ~ ± 10 %
Current consumption:	max. 120 mA
Current consumption at system connector:	6 mA
Ambient temperature:	-5 ... +45 °C
Storage/transport temperature:	-25 ... +70 °C
Humidity	
Ambient/storage/transport:	max. 93 % r. h., no condensation
Mounting width:	72 mm (4 rail units)
Weight:	approx. 155 g
Terminals	
Outputs, power supply:	screw terminals
single wire:	0.5 ... 4 mm ²
stranded without ferrule:	72 mm (4 rail units)
stranded with ferrule:	0.5 ... 2.5 mm ²
Connection KNX device:	KNX bus connection block
Analogue outputs	
Number:	4
Ranges:	0 ... 1 V DC, 0 ... 10 V DC, 0 ... 20 mA DC, 4 ... 20 mA, DC
Voltage signal load:	≥ 1 kW
Current signal load:	≤ 500 W

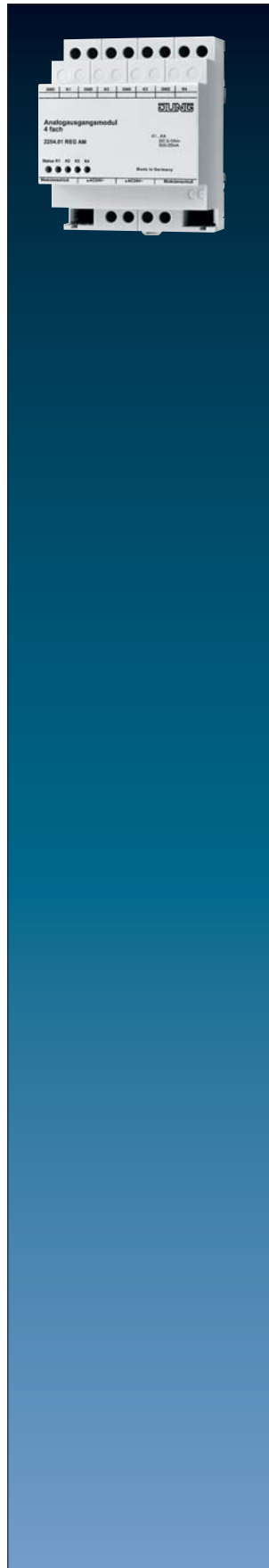

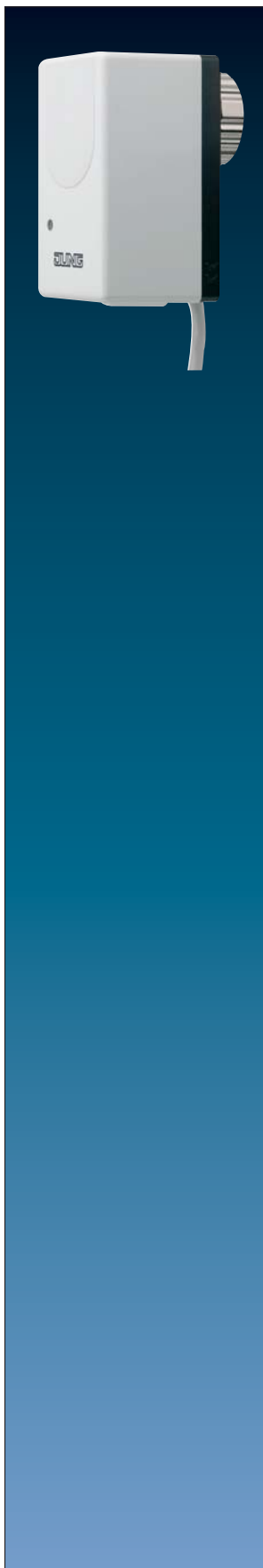

Ref.-no.

Valve drive (motor-operated)

electromechanical servo drive

2176 SV

Dimension: 46 x 87 x 60 mm

The KNX valve drive is connected directly to the KNX without an additional bus coupling unit. An external power supply is also not necessary, the valve is supplied by the bus. The physical address has to be set with a magnet instead of a programming push-button. Together with the steady controlled temperature sensor 2178 or RCD, the valve receives a 8 bit regulation variable, resulting in 256 positions of the valve. The valve is suitable to be mounted to all thermostat valve bottoms for temperature regulation with e.g. radiators, floor heating, convectors etc.

It offers two additional potential free inputs where e.g. window-contacts can be connected. The inputs also can be used to connect conventional push-buttons or switches which can act directly on the valve drive or can be used for any other KNX functions.

Note: Before use, check the valve bottom parts!

Technical data**Supply**

Voltage: 24 V DC (+6 V / -4 V)
 Power consumption: max. 240 mW (max. 12 mA at 20 V)
 Connection: KNX connection block via prepared connection pipe (1m (J)EYY-OB 3 x 2 x 0.6)

Input

Number: 2
 Signal voltage: 20 V impulses, duration approx. 3 ms
 Signal current: approx. 1 mA per channel

Output

Number: 1
 Stroke: max. 4.5 mm
 Run time: 25 s/mm
 Connection: to be put onto the valve bottom with gentle pressure and fixed with a suitable pliers.
 Protection: IP 44 (vertically mounted)
 Behavior at bus voltage drop: valve drive stops in its last position
 recovery: the valve drive runs through an adjustment routine and afterwards drives into the parameterized control variable. Inputs will be read out and sent to the bus, depending on parameters.
 Operation temperature: 0°C ... +50°C
 Storage temperature: -20°C ... +70°C
 Mounting: screwed onto valve bottom parts from Heimeier (other bottom parts have to be checked)

Ref.-no.

**Flush-mounted switch actuator, 1-gang
with satellite input**

1 make contact, 2 binary inputs
ETS product family: Output
Product type: Binary output

2131.16 UP**Product characteristics**

- Operation as NO or NC contacts
- Logic and restraint function
- Switching feedback (bus operation only)
- Disabling function for each channel
- Timing functions: switch-on or switch-off delay time, staircase lighting timer with pre-warning function
- Operating hours meter, configurable via bus
- Input monitoring for cyclical updating with safety circuit
- No additional power supply necessary
- Two binary inputs for floating contacts, can be used as satellite inputs for local control or for any other KNX function

Technical data**Output**

Number:	1
Switch type:	floating make contact (μ -contact)
Max. switching voltage:	AC 230 V ~
Max. switching current:	16 A at 230 V AC
Switching capacity	
Incandescent lamps:	2200 W
HV halogen lamps:	2200 W
capacitive load:	AC 230 V, 10 A, max. 105 μ F
conventional transformers:	1000 VA
TRONIC transformers:	1000 W

Terminals

Output cable:	L and L', colour brown, 1,5 mm ² , length approx. 20 cm
Bus and control cable:	KNX + red KNX - black binary input 1 green GND white binary input 2 yellow GND brown length approx. 33 cm, extendible to 5 m max.
Satellite input:	depending on parameterization either as extension inputs for push-button local control of the actuator or as independent binary inputs acting on the bus
Dimensions:	Ø 53 mm, height 28 mm

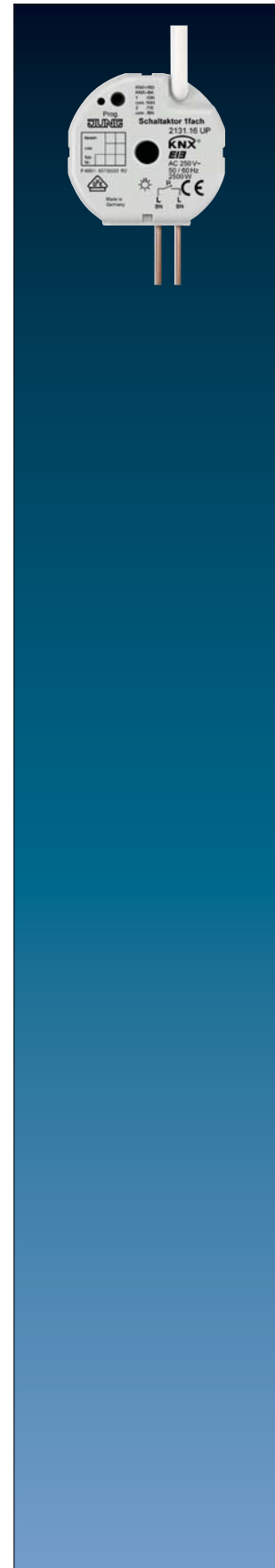

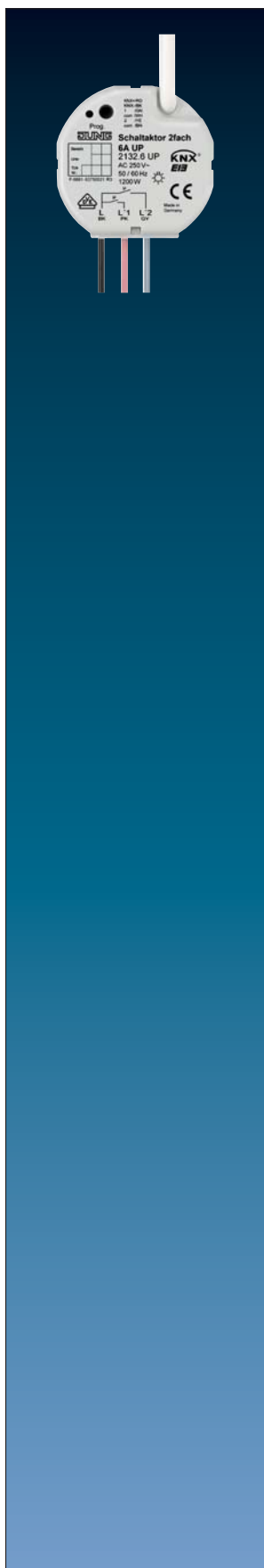

Ref.-no.

Flush-mounted switch actuator, 2-gang with satellite input

2 make contacts, 2 binary inputs

ETS product family: Output

Product type: Binary output

2132.6 UP

Product characteristics

- Operation as NO or NC contacts
- Logic and restraint function
- Switching feedback (bus operation only)
- Disabling function for each channel
- Timing functions: switch-on or switch-off delay time, staircase lighting timer with pre-warning function
- Operating hours meter, configurable via bus
- Input monitoring for cyclical updating with safety circuit
- No additional power supply necessary
- Two binary inputs for floating contacts, can be used as satellite inputs for local control or for any other KNX function

Technical data

Output

Number:	2
Contact type:	floating relay contacts (μ contact)
Switch type:	make contact
Max. switching voltage:	AC 230 V ~
Max. switching current:	2 x 6 A at 230 V AC
Switching capacity	
Incandescent lamps:	1200 W
HV halogen lamps:	1200 W
capacitive load:	AC 230 V, 6 A, max. 14 μ F
conventional transformers:	500 VA
TRONIC transformers:	500 W

Terminals

Output cable:	L, L'1, L'2, black, pink, grey, 1.5 mm ² , length approx. 20 cm
Bus and control cable:	KNX + red KNX - black binary input 1 green GND white binary input 2 yellow GND brown length approx. 33 cm, extendible to 5 m max.
Satellite input:	depending on parameterization either as extension inputs for push-button local control of the actuator or as independent binary inputs acting on the bus
Dimensions:	Ø 53 mm, height 28 mm

Ref.-no.

**Flush-mounted blinds actuator, 1-gang
with satellite input**

3 binary inputs

ETS product family: Shutter

Product type: Shutter

2501 UP**Product characteristics**

- Switching of venetian blinds, awnings and similar hangings with AC 110 ... 230 V~
- Installation into standard wall box with Ø 60 mm
- Terminals for connection are included
- Three binary inputs for floating contacts, can be used as satellite inputs for local control or for any other KNX function
- Power supply via bus, no additional power supply necessary

Blinds function

- Direct control of blind position
- Direct control of slat position
- Acknowledgement of movement, blind position and slat position
- Forced position by superior control
- Safety function: 3 independent wind alarms, rain alarm, frost alarm
- Sun protection function

Technical data

Rated voltage:	AC 110 ... 240 V ~, 50/60 Hz
Switching voltage:	AC 250 V ~
Ambient temperature:	-5 ... +45 °C
Storage/transport temperature:	-25 ... +70 °C
Blinds output	
Contact type:	μ
Switching current AC1 (cos φ > 0.8):	3 A
Min. switching current AC:	100 mA
Motors (230 V):	600 VA
Motors (110 V):	300 VA
Control cable:	
Input type:	floating contact
Total cable length:	max. 5 m
Voltage satellite inputs:	approx. 5 V
Dimensions (Ø x H):	53 x 28 mm
Wiring:	
single wire:	1 ... 2.5 mm ²
KNX supply:	DC 21 ... 32 V SELV
Power consumption KNX:	max. 240 mW
Wiring, KNX:	terminal connected to control cable

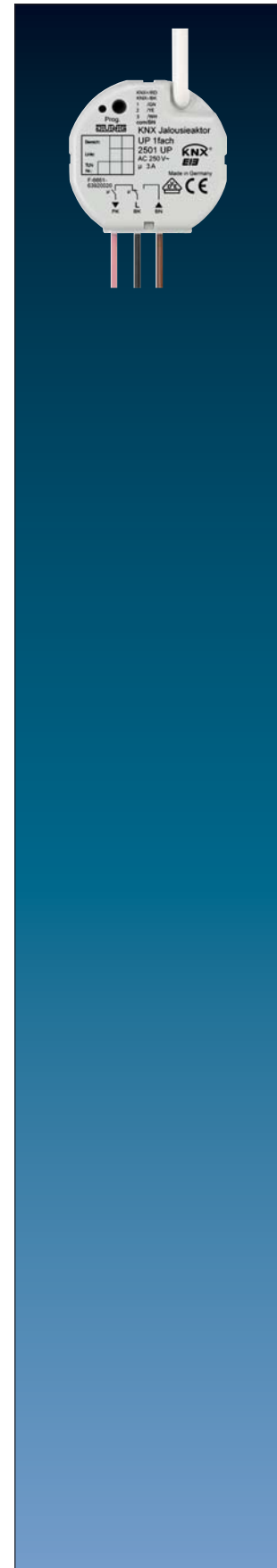

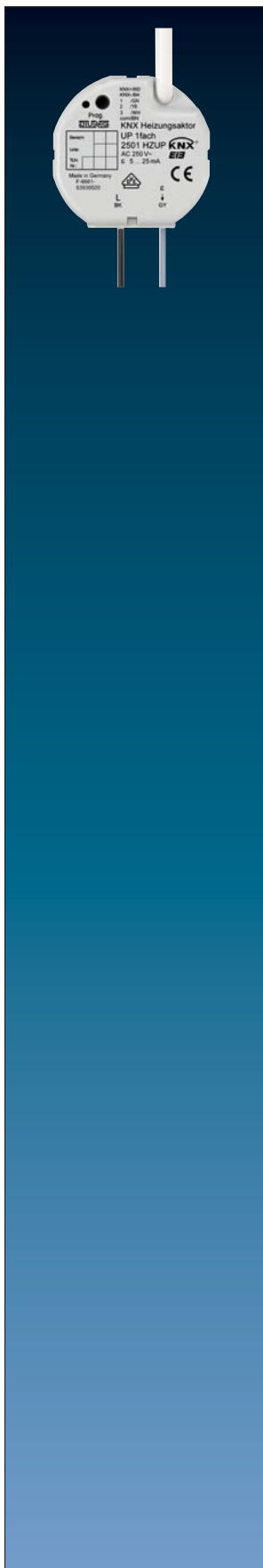

Ref.-no.

Flush-mounted heating actuator, 1-gang with satellite input

3 binary inputs

1 output "TRIAC"

ETS product family: Heating, A/C, Ventilation

Product type: Valve

2501 HZ UP

Product characteristics

- Switching of electrothermal valve drives
- Installation into standard wall box with \varnothing 60 mm
- Terminals for connection are included
- Three binary inputs for floating contacts, can be used as satellite inputs for local control or for any other KNX function
- Power supply via bus, no additional power supply necessary

Function of valve drives

- ON/OFF operation mode or PWM operation mode
- Valve drive types "normally open" or "normally closed" can be controlled
- Overload-proof, short-circuit proof
- Protection against blocked valves
- Forced position
- Cyclical monitoring of input signals can be parameterized

PWM operation mode: electrothermal valve drives have only 2 positions: "open" and "closed". The PWM mode has a quasi-continuous behaviour by means of switching ON and OFF during the cycle time of the valve drive.

Technical data

Rated voltage:	AC 230/240 V ~, 50/60 Hz
Switching voltage:	AC 250 V ~
Ambient temperature:	-5 ... +45 °C
Storage/transport temperature:	-25 ... +70 °C
Heating output	
Contact type:	semiconductor (triac), ϵ
Switching current:	5 ... 25 mA
Switch-on current:	max. 600 mA (2 s)
Number of drives per output:	max. 2
Control cable:	
Input type:	floating contact
Total cable length:	max. 5 m
Voltage satellite inputs:	approx. 5 V
Dimensions (\varnothing x H):	53 x 28 mm
Wiring:	
single wire:	1 ... 2.5 mm ²
KNX supply:	DC 21 ... 32 V SELV
Power consumption KNX:	max. 240 mW
Wiring, KNX:	terminal connected to control cable

Ref.-no.

**Flush-mounted room climate interface
with satellite input**

3 binary inputs

1 blinds output, 1 output "TRIAC" (heating)

2531 UP**Product characteristics**

- Switching of venetian blinds, awnings and similar hangings with AC 230 V~
- Switching of electrothermal valve drives
- Installation into standard wall box with Ø 60 mm
- Terminals for connection are included
- Three binary inputs for floating contacts, can be used as satellite inputs for local control or for any other KNX function
- Power supply via bus, no additional power supply necessary

Blinds function

- Direct control of blind position
- Direct control of slat position
- Acknowledgement of movement, blind position and louvre position
- Forced position by superior control
- Safety function: 3 independent wind alarms, rain alarm, frost alarm
- Sun protection function

Function of valve drives

- ON/OFF operation mode or PWM operation mode
- Valve drive types "normally open" or "normally closed" can be controlled
- Overload-proof, short-circuit proof
- Protection against blocked valves
- Forced position
- Cyclical monitoring of input signals can be parameterized

PWM operation mode: electrothermal valve drives have only 2 positions: "open" and "closed". The PWM mode has a quasi-continuous behaviour by means of switching ON and OFF during the cycle time of the valve drive.

Technical data

Rated voltage: AC 230/240 V ~, 50/60 Hz

Switching voltage: AC 250 V ~

Ambient temperature: -5 ... +45 °C

Storage/transport temperature: -25 ... +70 °C

Blinds output

Contact type: μ
 Switching current AC1 ($\cos \varphi > 0.8$): 3 A
 Min. switching current AC: 100 mA
 Motors (230 V): 600 VA

Heating output

Contact type: semiconductor (triac), ϵ
 Switching current: 5 ... 25 mA
 Switch-on current: max. 600 mA (2 s)
 Number of drives per output: max. 2

Control cable:

Input type: floating contact
 Total cable length: max. 5 m
 Voltage satellite inputs: approx. 5 V

Dimensions (Ø x H):

53 x 28 mm

Wiring:

screwless terminals

single wire: 1 ... 2.5 mm²

KNX supply: DC 21 ... 32 V SELV

Power consumption KNX: max. 240 mW

Wiring, KNX: terminal connected to control cable

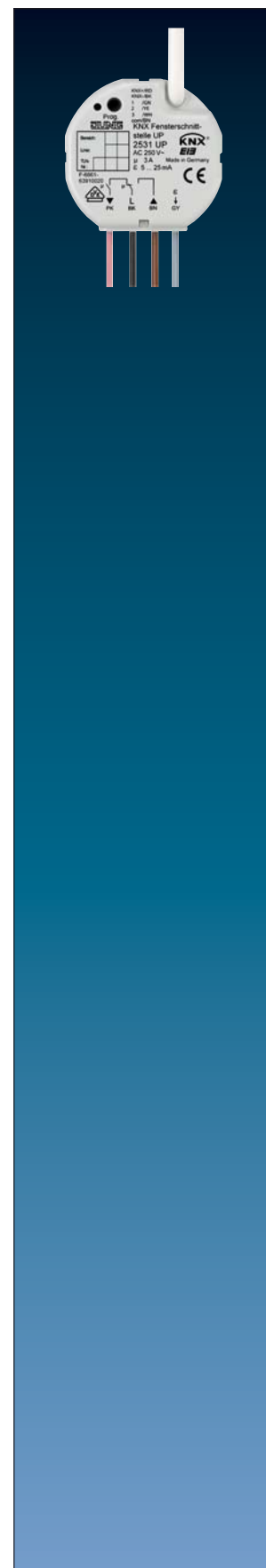

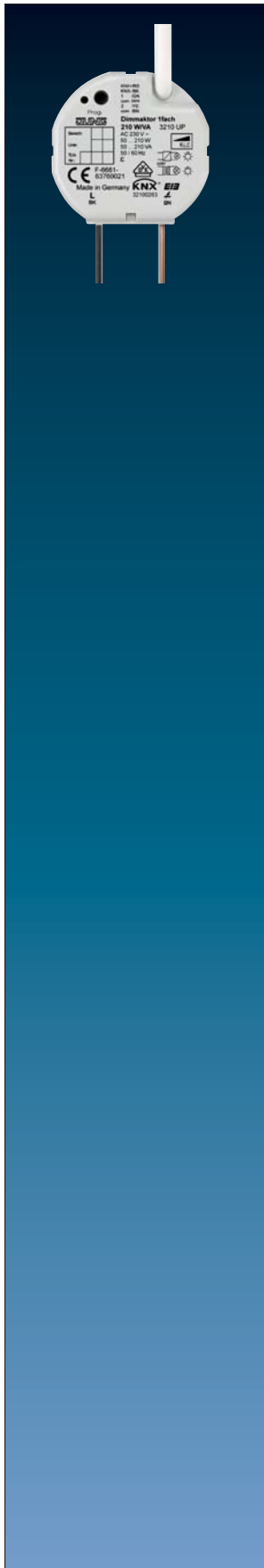

Ref.-no.

Flush-mounted dimming actuator, 1-gang, 50 – 210 W/VA with satellite input

2 binary inputs

ETS product family: Illumination

Product type: Dimmer

3210 UP

Product characteristics

- Automatic or manual selection of corresponding dimming principle
- Short-circuit and overtemperature protected
- Short-circuit and load failure message
- Acknowledgement of switching state and brightness value
- Switch-on and dimming behaviour can be set
- Timing functions: switch-on delay / switch-off delay time, staircase lighting time
- Disable function for each channel
- Light scene function

Technical data

Output:	1 Power MOS-FET
Dimming method:	trailing edge or leading edge phase control
Terminals	
Output cable:	L = black, = brown, 0.75 mm ² length approx. 20 cm
Bus and control cable:	KNX + red KNX – black binary input 1 green GND white binary input 2 yellow GND brown length approx. 33 cm, extendible to 5 m max.
Satellite input:	depending on parameterization either as extension inputs for push-button local control of the actuator or as independent binary inputs acting on the bus
Dimensions:	Ø 63 mm, height 25 mm
Rated voltage:	AC 230 V ~, 50 Hz, neutral line required
Rated current:	0.9 A
Minimum load:	50 W
Power loss:	2 W
Total connected load:	210 W/VA
ohmic load:	50 ... 210 W
Incandescent lamps:	50 ... 210 W
HV halogen lamps:	50 ... 210 W
LV halogen lamps with:	
– conventional transformer:	50 ... 210 VA
– TRONIC transformer:	50 ... 210 VA
	Mix of the specified load types (do not mix capacitive loads with inductive loads).
	When using mixed loads with conventional transformers, the ohmic load must not exceed 50 %.

Do not connect any electronic lamps, e.g. switchable or dimmable compact fluorescent lamps or LED lamps. Device can be damaged.

KNX alarm system

The KNX alarm system is persuasive due to its sophisticated, practical structure. At its core is the control unit which regulates all the processes. The planning, installation and commissioning is carried out via the ETS software. The system consists in essence of the following elements and functions:

- alerting: various devices for the loud and silent alarm
- display: distributed retrieval of alarm signals via CTP, RCD or FAP
- arming: the activation is carried out via key-operated switches
- set/unset: there is a blocking element for use at the entrance door
- detection: a comprehensive range of movement detectors, contacts and sensors fulfils all the monitoring tasks in rooms as well as at doors and windows





Ref.-no.

TC Plus KNX analogue

ETS product family: Communication

Product type: Modem

2601

The TC Plus is mainly developed for an analogue telephone network. Optional it can be used also via an analogue port of an ISDN unit.

The TC Plus is an alarming and remote switching device by which up to 6 conventional devices can be switched via telephone. All settings will be saved in case of a power failure – except for time and date. The behaviour of the outputs in case of a power failure can be set (after return of the power voltage: ON, OFF or restoring the switching state before the power failure). Conventional relays or current-impulse switches can be connected to the switching outputs. Furthermore, the TC Plus is sending messages to selected participants (cf. phone numbers). These messages are activated by up to 6 contacts (series) which are connected to the alarm inputs (N1 to N6). At each of the inputs break or make contacts can be installed. Additionally, when connected to KNX, up to twenty communications objects can be controlled and up to 6 alarms can be processed. Should given messages – send off by the alarm inputs M1 to M6 or by KNX – not be confirmed, a local alarm output will be switched.

The controlling will either be performed with a DTMF telephone (DTMF = Dual-tone multi-frequency) or with a DTMF pocket dialer (optional).

In case of an answering machine being used at an analogue connection (AB mode), either the answering machine or the TC Plus can be addressed.

The TC Plus is operated by turnkey. Operation is supported by plain texts on a 20 character 4 line alphanumeric LCD field and also by announcements. The user can choose among 6 display languages for the messages.

The following versions are available on request:

TC Plus KNX ISDN

Recommended if only ISDN connections are available and the ISDN telephone system has neither analogue ports nor ISDN terminal adapters. The TC Plus ISDN can be connected directly to the S₀-bus.

TC Plus KNX GSM

Security and convenience is possible even without having a landline. The TC Plus GSM requires only a SIM card.

TC Plus KNX analogue REG

Rail mounting device, 8 rail units

Technical data

Dimensions (W x H x D):	204 x 251 x 49 mm
Weight:	approx. 610 g
Colour:	RAL 7035, light grey
Rated voltage:	plug power supply Input: AC 100 ... 240 V ~, 50/60 Hz Output: DC 12 V / 1.2 A alternative: external 12 V DC power supply
Protection level:	IP 30 acc. to DIN 60 529
Operating temperature:	-5 ... +45 °C
6 signalling inputs	Bus Interface Module BIM 113 for floating make contacts or break contacts
6 switching outputs	12 V DC, 100 mA
1 local alarm	12 V DC, 100 mA total max. rating of all outputs max. 700 mA, short circuit proof and surged with 200 mA

Ref.-no.

Radio-KNX converter

ETS product family: Communication

Product type: Radio

2700 AP**Intended use**

- Integration of radio transmitters into KNX installations
- Surface-mounting in indoor areas

Product characteristics

- Reception of radio telegrams and forwarding of commands in KNX installations
- 50 radio channels can be saved
- 100 control functions can be saved, e.g. hand transmitter rockers, motion detectors

Technical data

Rated voltage KNX:	DC 21 ... 32 V SELV
Power consumption KNX:	typical 170 mW
Wiring, KNX:	terminal
Carrier frequency:	433.42 MHz (ASK)
Number of possible radio transmitter:	max. 100
Channel display supply	
Battery type:	Alkaline 6LR61
Power consumption:	approx. 140 mW
Ambient temperature:	-5 ... +45 °C
Protection class:	III
Dimensions (W x H x D):	110 x 94 x 38 mm



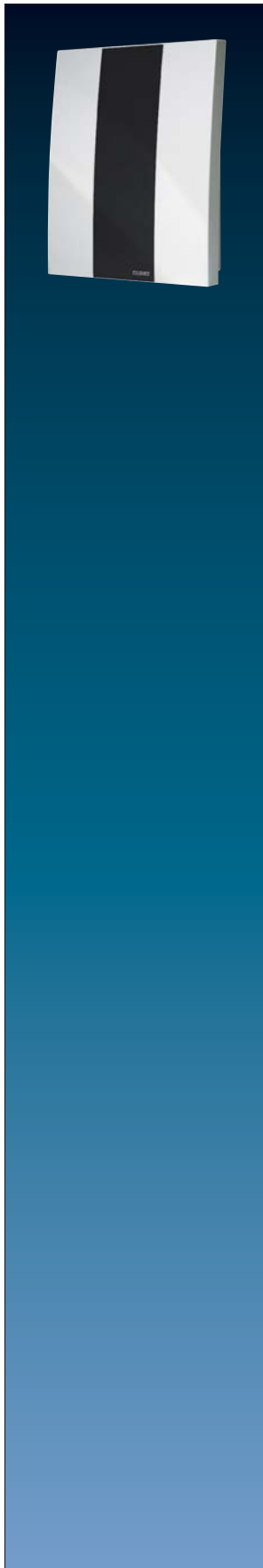

Ref.-no.

EAM 4000**KNX Alarm central unit**

ETS-product family: Alarm system

Product type: Alarm central unit

The alarm central unit is a modern alarm system using the KNX system.

Detailed knowledge about planning, designing and commissioning of alarm systems are absolutely required.

The alarm central unit is a modern intruder alarm system using the KNX system for the transmission of information. It keeps an object under surveillance and detects and signals intrusion attempts. The system is no substitute for any mechanical safeguarding devices which prevent intrusion into your property. You can use the alarm central unit as a comfortable extension for any existing KNX installations.

The alarm central unit has been designed in compliance with VdS (German Association of the Damage/Loss Insurers) guidelines.

The functionality of the device is dependent on the parameters of the software application.

By using the KNX the additional wiring and cabling effort of a separate alarm system can be reduced to a minimum. This is achieved by using sensors, i.e. movement detector not just purely for lighting control or alarm systems.

Technical data**Input supplying**

Voltage:	230 V AC, $\pm 10\%$, 50/60 Hz
Power consumption:	max. 24 W
Current secondary:	max. 50 mA; during changing process approx. 200 mA
Fuses:	F1 = T 100 mA (5 V supply of central unit) F2 = T 100 mA (12 V power supply) F3 = T 100 mA (supply for telephone dialer) F4 = T 3.15 A (main fuse 230 V) F5 = T 3.15 A (protection of accumulator)
Output voltage for alarm device:	SELV 12 V DC, ± 2 V
Max. capacity of outputs:	Telephone dialer: 100 mA 12 V supply: 100 mA Sirens/flash in total: 1.6 A (electronic overload protection)
Capacity of relay:	SELV 12 V (AC/DC), 5 A (min. 30 mA)
Storage battery:	12 V / 1.2 Ah
Charge voltage:	approx. 13.4 V
Charge current:	approx. 150 mA
Supply KNX:	SELV 21 V – 32 V
Power consumption:	max. 240 mW

Connection

KNX:	KNX connection block
mains:	screw terminals up to 1.5 mm ²
Spare accumulator:	12 V/1,2 Ah, ref.-no.: DAS 4512
Protection:	IP 20
Operation temperature:	-5°C ... +45°C
Storing temperature:	-25°C ... +70°C
Dimension:	210 x 270 x 73 mm
Weight:	approx. 1500 g (including accumulator)
Event memory:	min. 80 events per security area 40 events for each fire and alarm
Length of wires:	to alarm devices: 100 m at 0.8 mm diameter to telephone dialer: 200 m at 0.6 mm diameter to wired detectors: 200 m at 0.8 mm diameter to sabotage line: 600 m at 0.8 mm diameter
Resistance of wired detectors:	max. 1 kOhm

System configuration

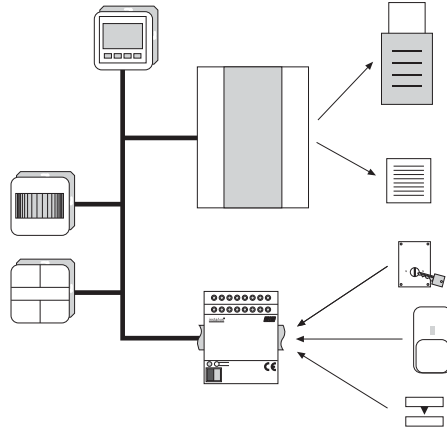

Note: For the planning and programming of the whole system it is absolutely necessary to have the knowledge about alarm systems and the specific terminology as well as a product training on the alarm central unit.

Functional features

- Up to 160 sensors can be administrated and integrated in up to 4 separate safeguarding areas.
- All sensors are connected via the KNX to the alarm central unit. Hence, the identification and monitoring of all sensors is obtained.
- All events (as arming, alarm, failure) are saved with time and date in a protocol.
- Alarm devices (as siren, flash or telephone dialer) can be connected directly to the alarm central unit or can be controlled via KNX.
- The alarm central unit has an integrated floating storage battery which, in case of mains failure, guarantees a back-up time of approx. 12 hours.
- The displaying and operation is done by external KNX devices like Info Display, push-buttons, etc. In one armed area several operation units can be applied.
- An additional local sensor input can be used to protect the location where the alarm central unit is mounted.
- Furthermore, a relay contact can be used to connect additional alarm devices.

The alarm central unit is developed for different applications. It starts in residential buildings with the protection of the outside body (windows, doors) and the interior and ends in office buildings, whereby up to 4 different security areas can be defined and protected separately or linked together.

Alarm system configurations

Due to many different parameterisation options, the KNX alarm central unit can be used in various objects – from the detached family house with outer shell and inner room safeguarding up to the office building where up to four arming areas (AA) can be safeguarded individually or in groups linked up with one another.

The following list shows the basic configurations which may also be combined with one another:

1 x inner room, 1 x outer shell (nested)*:

Detached family house, flat.

(AA1 = outer shell, AA2 = inner room;

AA 1 can be armed individually or together with AA2).

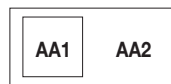

2 x [1 x inner room, 1 x outer shell (nested)*]:

Two-family house, house with granny flat,

2 separate safeguarding areas (workshop with flat).

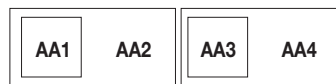

Up to 4 separate areas:

Shopping arcade, holiday houses, hotel/pension, trade fair/exhibition halls.



Up to 4 separate areas (cascaded)**:

Office/industrial building, sports hall.

(AA4 only to be armed if AA1 to AA3 have already been armed).

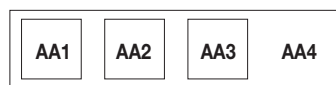

* nested: The subordinate area is armed together with the higher-order area.

** cascaded: The higher-order area can only be armed if the subordinate areas have already been armed.

Fire and attack detectors

Regardless of the configuration of the system, the fire and attack areas are always active. If a fire or attack detector is activated, the system will immediately set off an alarm, regardless of what its state is.

As a special variant, the alarm central unit can also be solely used for “attack” and “fire”.



	Ref.-no.
Outdoor siren with flash light	DAS 4110
Rated voltage: 12 V DC	
Protection: IP 34	
Indoor siren	DAS 4120
Rated voltage: 10 – 28 V DC	
Protection: IP 32	
TC Plus KNX analog	2601
Automatic alarm dialer, Digital	DAS 4610 only on special request
The digital automatic dialer provides a silent transmission of an alarm or malfunction to a permanent available security service.	
Automatic alarm dialer, Analog	FUS 4620
The analog automatic dialer provides a silent transmission of an alarm or malfunction.	
4 alarm inputs	
4 outputs to be switched via phone	

	Ref.-no.
Surface mounted key switch For activating and deactivating of alarm systems Front plate material: Pressure casted aluminium	DAS 4300 A
Flush-mounted key switch Front plate material: Lost-wax casted aluminium (profile cylinder lock is not included!)	DAS 4300 U
Movement detector Passive infrared detection principle Detected area: 90° (volumetric) 34 double zones in 3 levels Maximum detected area approx. 15 x 15 m	DAS 4210
Frame joint switch contact	DAS 4360
Glass-break sensor, passive	FUS 4415 WW
Magnet contact white	FUS 4410 WW
brown	FUS 4410 BR

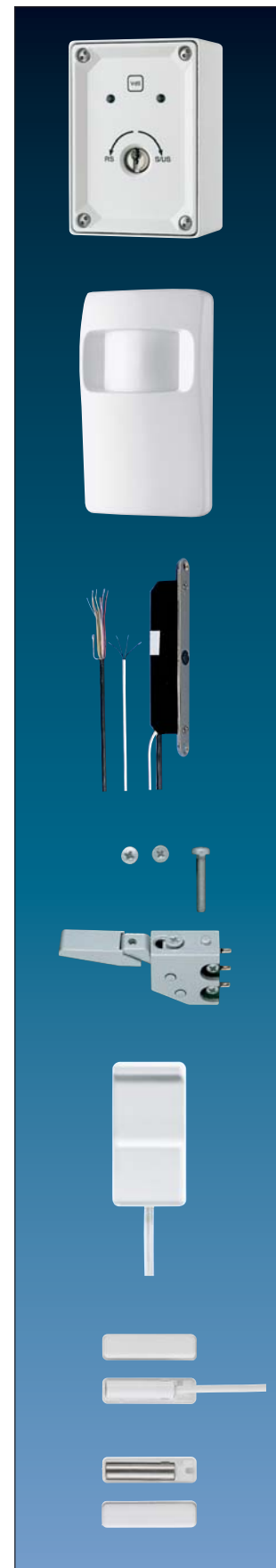

Smart Displays

A full version of the “Facility Pilot” building system software is preinstalled on the Smart Pilots and the Smart Pilot 9.7 for wall mounting. Together with the intuitive operator interface, the control and visualisation of KNX room functions and multimedia is extremely easy and convenient via the colour touch screen.

All the Smart Pilots have integrated loudspeakers and microphones; version 9.7 also has a 1.3 megapixel camera.

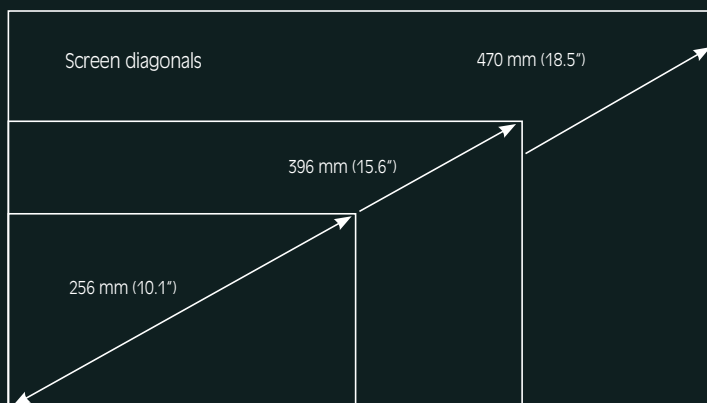

For the SMART PILOT PCs, there are design frames in aluminium or glass in white and black. There are three different screen diagonals available with an aspect ratio of 16:9: 10" version with 223 x 125 mm and a resolution of 1024 x 600 pixels (WSVGA), 15" version with 344.2 x 193.5 mm and a resolution of 1366 x 768 pixels (WXGA), 19" version with 409.8 x 230.4 mm and a resolution of 1366 x 768 pixels (WXGA). A full version of the Facility Pilot software has already been preinstalled on the SMART PILOT.

JUNG





Ref.-no.

Flat panel PC

for installation in walls, resistive touch screen
 fanless, without rotating parts
 switched-off PC can be activated via LAN (wake on LAN)

SP 10 FAPVD-GB**SP 15 FAPVD-GB****SP 19 FAPVD-GB****Technical data****SP 10 FAPVD-GB**

Screen size (W x H): 156 mm / 10.4"
 Resolution: WSVGA (1024 x 600),
 LED Backlight Display

SP 15 FAPVD-GB

Screen size (W x H): 396.2 mm / 15.6"
 Resolution: WXGA (1366 x 768)

SP 19 FAPVD-GB

Screen size (W x H): 470.1 mm / 18.51"
 Resolution: WXGA (1366 x 768)

Start/reset button: accessible from the front
 Operating system: Windows Embedded Standard 2009,
 German and English pre-installed,
 other languages on request
 Software: JUNG Facility Pilot full version pre-installed
 (English version)
 DIVUS video phone software for integration of DCM
 devices pre-installed
 Remote maintenance: possible via internet/LAN
 Loudspeaker: integrated
 Microphone: integrated
 Processor: Intel® Atom™ N270, 1.6 GHz, 512 K L2 Cache
 Memory: DOM 4 GB, RAM 2 GB
 USB ports: 2 at the reverse side, 2 accessible from the front
 LAN connections: 2 (separate) at the reverse side, 1000 Mbit/s
 Rated voltage: AC 90 ... 260 V ~, 50/60 Hz

	Ref.-no.
Frame (dyes glass – aluminium frame)	
for flat panel PC ref.-no.: SP 10 FAPVD-GB	
333 x 200 mm	
white	RSP 10 WW D
black	RSP 10 SW D
for flat panel PC ref.-no.: SP 15 FAPVD-GB	
510 x 306 mm	
white	RSP 15 WW D
black	RSP 15 SW D
for flat panel PC ref.-no.: SP 19 FAPVD-GB	
600 x 306 mm	
white	RSP 19 WW D
black	RSP 19 SW D
Flush-mounted recessed box	
for flat panel PC 10.4" ref.-no.: SP 10 FAPVD-GB	
cut-out dimensions (W x H): 315 x 182 mm	
installation depth: 80 mm	
for flat panel PC 15.6" ref.-no.: SP 15 FAPVD-GB	
cut-out dimensions (W x H): 492 x 288 mm	
installation depth: 80 mm	
for flat panel PC 18.51" ref.-no.: SP 19 FAPVD-GB	
cut-out dimensions (W x H): 582 x 327 mm	
installation depth: 80 mm	
Installation kit for hollow walls (Flush-mounted recessed box is not required for hollow wall installation.)	
for flat panel PC ref.-no.: SP 10 FAPVD-GB	
cut-out dimensions given by the attached cutting template	
installation depth: 80 mm	
for flat panel PC ref.-no.: SP 15 FAPVD-GB	
cut-out dimensions given by the attached cutting template	
installation depth: 80 mm	
for flat panel PC ref.-no.: SP 19 FAPVD-GB	
cut-out dimensions given by the attached cutting template	
installation depth: 80 mm	
Build-in kit for flush installation (only for hollow walls)	
for Smart Pilot ref.-no.: SP 10 FAPVD-GB	
cut-out dimensions (W x H): 328 x 196 mm	
installation depth: 90 mm	
for Smart Pilot ref.-no.: SP 15 FAPVD-GB	
cut-out dimensions (W x H): 506 x 302 mm	
installation depth: 90 mm	
for Smart Pilot ref.-no.: SP 19 FAPVD-GB	
cut-out dimensions (W x H): 596 x 341 mm	
installation depth: 90 mm	



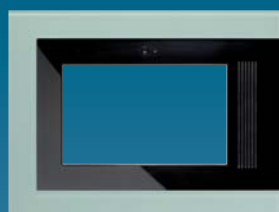
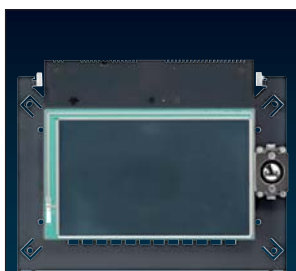

Ref.-no.

Flat panel PC

for installation in walls, resistive touch screen
fanless, without rotating parts

SP 9 FAPVE-GB

Technical data

Screen diagonal: 228 mm / 9", aspect ratio 16:9
 Resolution: WVGA (800 x 480)
 On/Off push-button: accessible from the front
 Operating system: Windows Embedded Standard
 Software: JUNG Facility Pilot full version pre-installed (English version)
 Remote maintenance: possible via internet/LAN
 Processor: Intel® Atom™ Z510, 1.1 GHz
 Memory: 2 GB SSD, 1 GB RAM
 Loudspeaker: integrated
 Microphone: integrated
 Camera: colour camera, 1.3 megapixels, line-out
 Audio input: line-in (stereo) analogue
 Video input: analogue
 USB ports: 2 x USB 2.0 (4-pole) at the reverse side
 accessible from the front:
 1 x USB 2.0 (4-pole)
 1 x USB client connection (mini AB, 5-pole)
 Card slot: SD Memory Card, accessible from the front
 LAN connections: 10/100 Mbit/s
 Rated voltage: AC 110 ... 230 V ~, 50/60 Hz

Frame

for flat panel PC ref.-no.: SP 9 FAPVE-GB

aluminium	R 9 AL E
stainless steel	R 9 ES E
glass	R 9 GL E

Aluminium frames have a satined and anodized surface.

Flush-mounted recessed box

for flat panel PC ref.-no.: SP 9 FAPVE-GB

dimensions (WxHxD) 212 x 124 x 75 mm	EBG 24
--------------------------------------	---------------

can also be used for hollow wall mounting

Ref.-no.

Colour touch panel IP

Intelligent building control with active colour TFT touch screen

FP 701 CT IP

The innovative touch panel puts the user in the position of being able to monitor and regulate the complete sequences involved in the management of lighting, blinds and roller shutters, heating and air-conditioning systems, alarm systems, signalling devices and audio components, all conveniently from a single location.

And indeed with navigation via a TFT touch screen (117.2 x 88.4 mm) with a brilliant resolution of 4096 colours and 320 x 240 pixels, whereby 8 colour schemes are available for selection. In addition to an accurate rendition of images and text, the monitor offers sufficient space to depict an individual background – in the form of photos, graphics our ground plans. The user interface can moreover be further optimised by retrieving drawings or flow charts for example onto the screen.

There is also the possibility of linking up to 50 standard pages as required and accessing them directly. This clearly simplifies navigation and scrolling via the menus. All together up to 400 different display elements can be assigned on the different pages. The programming of the panel is carried out via the KNX or via the USB interface behind the frame which can be accessed from the front without any problems. When configuring the mini panel, the menus and sub-menus can be set up as required and various KNX functions can be assigned.

Standard functions such as switching, dimming, shutter control and display of measured values can also be configured. The formation of limiting values (up to 16) is also possible. An internal real time clock is available for the execution of time functions (16 channel with 8 switching times per channel).

The colour touch panel comes without the design frame and the flush mounted recessed box !

Frame

for colour touch panel IP ref.-no.: FP 701 CT IP

stainless steel	FP ES 781
aluminium	FP AL 781

glass	FP GLAS 781
glass with JUNG logo	FP GLAS 781 EX

safety glass acc. DIN 1249
 satined surface
 Dimension: 236 x 170 x 10 mm (W x H x D)

Frame

for colour touch panel IP ref.-no.: FP 701 CT IP

industrial version

anthracite	FPI 781 AN
------------	-------------------

Dimension: 236 x 170 x 6 mm (W x H x D)





Ref.-no.

LCD mini panel

For monitoring and controlling KNX functions
 4 freely programmable function push-buttons
 With display illumination
 Power supply AC 230 V ~

MT 701

Intended use

- Operating loads and displaying the status of systems and information e.g. light switching, dimming, controlling blinds/shutters, temperature and consumption values etc.
- Flush-mounted installation in hollow or solid walls in the interior

Product characteristics

- Illuminated programmable screen, 240 x 128 pixels
- RS 232 port for quick programming using PC
- Max. 50 display pages with 8 display/switching options each
- 4 function buttons, freely programmable for each display line
- Max. 25 wallpapers, e.g. company logo, floorplan drawings; can be used on every display page
- Timer function with 16 channels and 8 switching times each
- Logic functions, e.g. logic operations, filter elements, blocking elements and timing elements
- Limit value monitoring
- Alarm reporting function
- Real-time clock, can be synchronised externally; cyclical transmission of the time
- Password protection possible for each page
- Max. 24 light scenes with up to 32 actuator groups

Technical data

Rated voltage:	AC 230 V ~, 50 Hz, neutral line required
Ambient temperature:	-5 ... +45 °C
Storage/transport temperature:	-25 ... +75 °C
Protection level:	IP 54 (depending on installation)
Overall dimension (W x H x D):	213 x 125 x 68 mm
Flush mounting dimension (W x H x D):	205 x 115 x 62 mm
Screen diagonal:	140 mm
Screen size (W x H):	123 x 69 mm
Wiring:	screw terminals
single wire:	0.5 ... 4 mm ²
stranded without ferrule:	0.5 ... 2.5 mm ²
stranded with ferrule:	0.25 ... 1.5 mm ²
Rated voltage KNX:	DC 21 ... 32 V SELV
Power consumption KNX:	typical 150 mW
Wiring, KNX:	terminal

Frame

for LCD mini panel ref.-no.: MT 701

Dimensions (W x H): 218 x 146 mm

white	R 24 WW
black	R 24 SW
stainless steel (lacquered)	R 24 ES
aluminium (lacquered)	R 24 AL

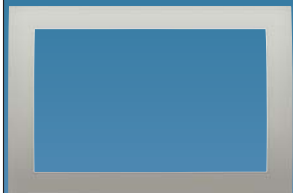

Flush-mounted recessed box

for LCD mini panel ref.-no.: MT 701

dimensions (WxHxD) 212 x 124 x 75 mm

can also be used for hollow wall mounting

EBG 24



Ref.-no.

Signal panel

MBT 2424

The glass panel with aluminium housing is equipped with 24 capacitive sensor buttons and 24 status LEDs. The panel enables the control of switching, dimming and push-button functions as well as light scene and value transmitter functions. The LEDs can be separately parameterized to be illuminated in green, red or blue to signalise different situations of the KNX installation. Single sensor buttons, full columns or the entire panel can be blocked with blocking functions.

Acoustic signals when pushing the sensor buttons can be parameterized.

The surface can be labelled with exchangeable labelling foils, which can be labelled with the JUNG labelling software.

The MBT 2424 will be installed into a 2-gang wall box.

Programming takes place via ETS. A drilling template and a bit for assembling will be delivered with the device.

Product characteristics

- Switching, dimming, push-button and blinds control, value transmitter and light scenes
- High quality glass surface with 24 sensor buttons
- Operation via touching the sensor buttons
- Labelling with exchangeable labelling foil
- Status feedback with 24 LEDs in 3 different colours
- Acoustical feedback for touching sensor and alarm signals
- Dismounting message possible
- Logic and time functions
- Blocking functions
- Integrated BCU

Technical data

External power supply	
Rated voltage:	AC/DC 24 V SELV
Power consumption:	approx. 8 W
Wiring, power supply:	connecting terminal yellow/white
single wire:	0.6 ... 0.8 mm ²
Dimensions (W x H x D):	front plate approx. 236 x 156 x 14 mm
Installation depth:	approx. 38 mm
Ambient temperature:	-20 ... +70 °C
Storage/transport temperature:	-20 ... +75 °C
Relative humidity:	15 ... 95 % relative humidity (r. h.), no condensation
Protection level:	IP 54
Protection class:	III
Rated voltage KNX:	DC 21 ... 32 V SELV
Wiring, KNX:	bus connection block
Power consumption KNX:	typical 150 mW

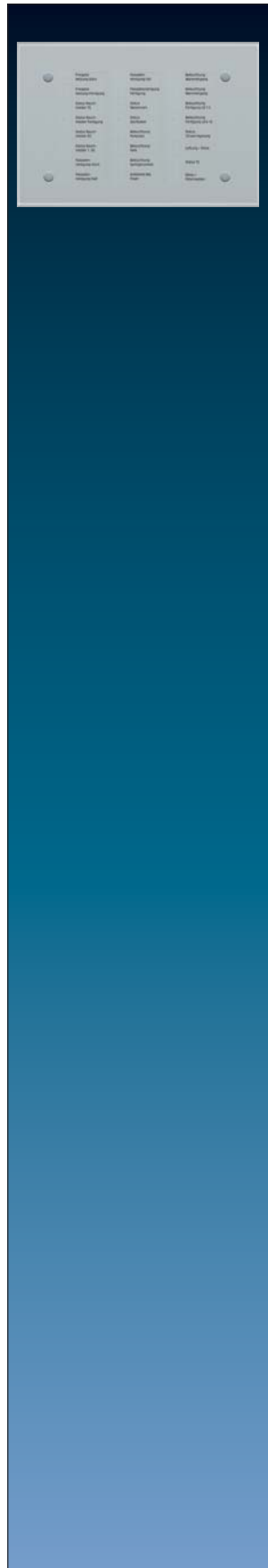

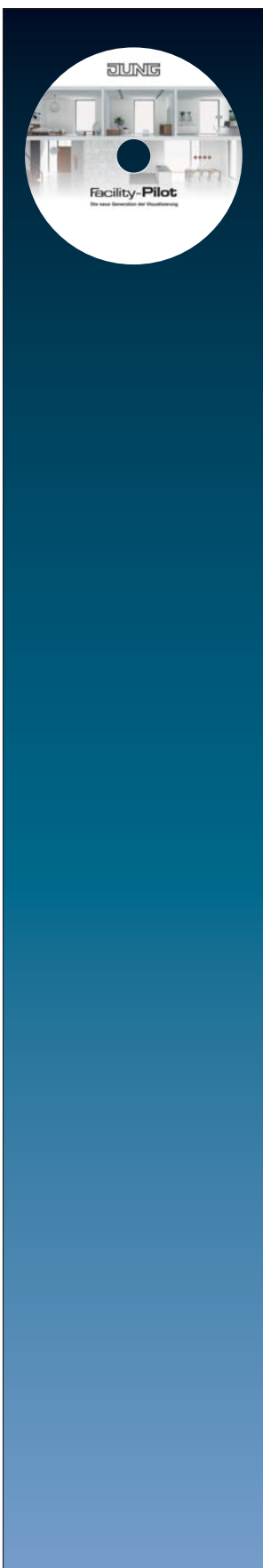

	Ref.-no.
Facility Pilot software	
Planner version	FAP-PL-3-GB
50 data point version	FAP-50-3-GB
300 data point version	FAP-300-3-GB
Full version	FAP-FULL-3-GB
Software version for network application (only in connection with FAP full version)	
Please note: 1 license per PC!	
	FAP-CL-3-GB

Note: The software is locked with a software key and must be activated within 20 days after the installation.

System requirements:

Windows XP, Internet Explorer 6, DirectX (version 9b), Adobe Reader
 For the installation under Windows XP administrator rights are required.
 Adobe Reader, Internet Explorer and DirectX are delivered with the FAP CD-ROM.

Recommended order of installation:

1. Internet Explorer
2. DirectX
3. Facility Pilot
4. Adobe Reader

Hardware requirements:

Pentium IV or equal, min. 1.2 GHz
 RAM: 256 MB
 Free space on hard disc: 40 GB (depending on the data processing / archives)
 Resolution: 1024 x 768
 Colours: min. 16 bit per pixel
 Interface: serial or USB for the application of FALCON
 Internet connection: (optional) when e-mail notification is used

Facility Pilot – the truly open visualisation generation

The JUNG Facility-Pilot is a flexible, interactive software for extensive visualisation and control of the building system technology KNX. Its areas of application extend from many different industrial applications through to up-market residential buildings.

The software consists of individual modules (Fig. A) such as the EIB editor, process model, visualisation editor and a comprehensive system control.

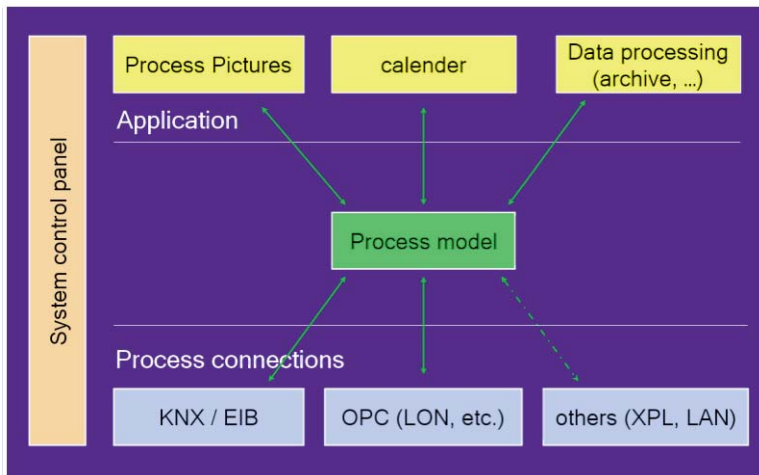

Fig. A

With the modular JUNG Facility-Pilot software system, a total solution for building management technology has been developed which opens up the topic of visualisation to a broad spectrum of users and moreover contains pioneering developmental steps as regards additional functionality such as access via the Internet. It is therefore not purely visualisation software but a comprehensive program which considerably simplifies operation with KNX and its connection with other bus systems.

This also fits in with the complete philosophy of the system which makes it possible to set up displays for process characteristics or archives for value characteristics and events without programming; even controller functions can be configured via drag & drop. And for specialists, there is also the possibility of visualisation programming if there are special requirements which are not covered by the system as standard.

The complete programming environment for BASIC scripts is a prerequisite for this.

KNX installations in private residential buildings can likewise be enhanced with the system as in the commercial sector since specific modules help to convert almost every technical requirement both quickly and economically – from the fault indication system to the entire technical building management system, culminating in the analysis of consumption data.

The navigation of the different modules is very easy due to the clear structured system control panel (Fig. B). This system control panel provides a fast overview of the whole system with the individual modules, documents and project management. The Facility-Pilot brings flexibility, greater user convenience and easy handling to bus system management. The visualisation and control assist the user with interactive help and extensive documentation.

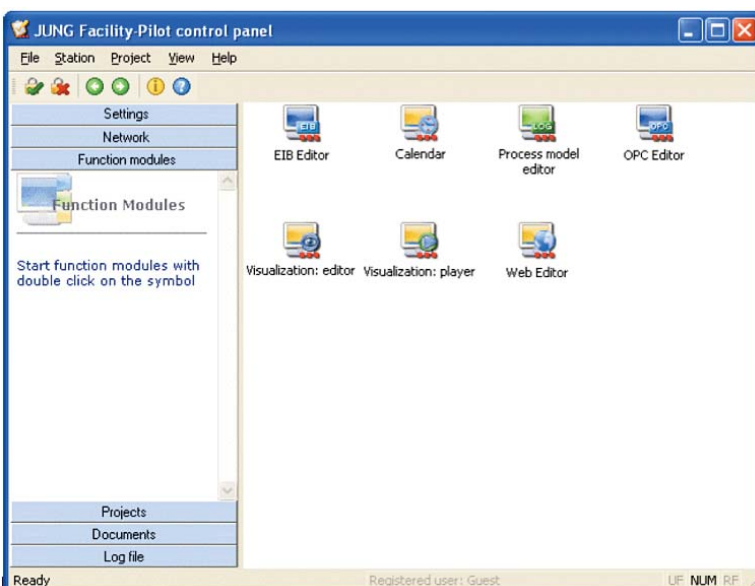

Fig. B

When developing the system, attention was directed at economic efficiency since logic modules or year time switches can be committed in many installations as the Facility-Pilot takes over these functions. The simple operation pays off quickly for the user.

Tools and assistants support the project engineers in their work while the end user has a high level of user friendliness and flexibility for his KNX installation. The technology remains discreetly hidden in the background.

Internet connection via integrated web-server will increase this convenience still further.

The visualisation is able to run on WINDOWS systems from WINDOWS 98SE to WINDOWS XP (with the exception of Windows NT). Your operating environment always retains the XP style.

KNX editor – the ETS interface

The main task of the KNX editor is to create the connection between the Facility-Pilot and the KNX. This editor can be used for a quick, convenient import of data from the ETS projects into the Facility-Pilot. For connection to KNX, the system uses the KNX Falcon driver. No additional software is needed. The KNX group addresses can be allocated either automatically by drag & drop or manually. Start group functions make it easy for the user to stipulate differentiated start behaviour of the system (Fig. C).

Fig. C

No.	Address	Designation	Value	Data point type	Unit	Rights
1	000001	F1 Isolation		Boolean	DPT_Switch	Read/Write
2	000002	F1 alarmen		8-Bit Unsigned Value		Read/Write
3	000003	F1 Wert		8-Bit Unsigned Value		Read/Write
4	000004	F1 Jalousie		Boolean	DPT_Switch	Read/Write
5	000005	F1 Jalousie		Boolean	DPT_Switch	Read/Write
6	000006	F1 Kontrollbetrieb		Boolean	DPT_Switch	Read/Write
7	000007	F1 Nachfrostschutz		Boolean	DPT_Switch	Read/Write
8	000008	F1 Frostschutz		Boolean	DPT_Switch	Read/Write
9	000009	F1 Testobjekt		Boolean	DPT_Switch	Read/Write
10	000010	F1 Solltemperatur		2-Octet Float Value		Read/Write
11	000011	F1 Isttemperatur		2-Octet Float Value		Read/Write
12	000012	F1 Stellgröße Heizen		Boolean	DPT_Switch	Read/Write
13	000013	F1 Jalousiewert		8-Bit Unsigned Value	DPT_Scaling	Read/Write
14	000014	F1 Plüsch. Bel.		Boolean	DPT_Switch	Read/Write
15	000020	F2 Isolation		Boolean	DPT_Switch	Read/Write
16	000021	F2 dimmen		8-Bit Unsigned Value		Read/Write
17	000022	F2 Wert		8-Bit Unsigned Value	DPT_Scaling	Read/Write
18	000023	F2 Jalousie		Boolean	DPT_Switch	Read/Write
19	000024	F2 Jalousie		Boolean	DPT_Switch	Read/Write
20	000025	F2 Kontrollbetrieb		Boolean	DPT_Switch	Read/Write
21	000026	F2 Nachfrostschutz		Boolean	DPT_Switch	Read/Write
22	000027	F2 Frostschutz		Boolean	DPT_Switch	Read/Write
23	000028	F2 Testobjekt		Boolean	DPT_Switch	Read/Write
24	000029	F2 Solltemperatur		2-Octet Float Value	DPT_Value_Temp	Read/Write
25	000030	F2 Isttemperatur		2-Octet Float Value		Read/Write
26	000031	F2 Stellgröße Heizen		Boolean	DPT_Switch	Read/Write
27	000032	F2 Jalousiewert		8-Bit Unsigned Value	DPT_Scaling	Read/Write
28	000033	F2 Plüsch. Bel.		Boolean	DPT_Switch	Read/Write
29	000040	F3 Isolation		Boolean	DPT_Switch	Read/Write
30	000041	F3 alarmen		8-Bit Unsigned Value		Read/Write

Below the table is a test window with columns: No., Time, Test.

In addition, the KNX editor works as a diagnosis tool in the system. For example, it assumes evaluation of the KNX telegrams and shows them in plain text. This gives the user perfect control of the bus system. I.e. it is not necessary to switch over between ETS and Facility Pilot to test or record data points, everything can be done within the KNX editor module.

OPC editor – the open interface

An OPC client which analyses which OPC servers are installed in the system (there can be several) is available as an option in the Facility-Pilot package. The client reads out the data from the OPC servers and makes it available to the process model. It can execute this in parallel with the EIB Editor.

Additional data from other processes e.g. LON or M-Bus can thus be linked with a KNX installation and visualised in a simple way. Planners and installers know that these requirements are found with increasing frequency in projects.

In practice, this can appear as follows: in parallel to the KNX process connection, an OPC server communicates with the LON devices located in the building and makes the data available via its software interface. The data is processed in the process model.

A link can now be implemented between the process variables.

The “forwarding function” (gateway function) is used for this purpose so that data is sent from LON to KNX and vice versa.

An additional gateway can thus be omitted since it already exists in the system.

A link to the Ethernet is also possible. The setpoint temperature or other parameters from control and instrumentation technology can for example be brought on the KNX.

Process model – comfort and safety with perfect workflows

The process model summarises the device data from the EIB editor or other physical connections and generates complete work-flows from individual functions. It is also possible to combine different sequences, e.g. blind control adjusted to the time of day and light conditions.

These functions (Fig. F) can also be adjusted to simulate the presence of people in the building when it is unoccupied.

The system thus also offers additional security. This aspect is reinforced if the KNX alarm system is integrated and controlled via the Facility-Pilot. The process model requires a logical view of the project, offering for example mathematical and time-based functions, or also scenarios and workflows for lighting control and monitoring functions. The user can easily draw up his own rules for the management of his facility.

To this end, “virtual devices” are created on the screen, archives are defined, e-mail notifications and alarm warnings are preset. If over the weekend a previously defined temperature is exceeded for example in office rooms with Facility-Pilot monitoring, the system issues a corresponding e-mail notification. Individual process data can

be recorded systematically and value progressions exported to Excel spreadsheets or displayed directly as graphs or tables (Fig. D and E). In addition the process variables can be linked with other programs via DDE. These can then be used to check the energy bills.

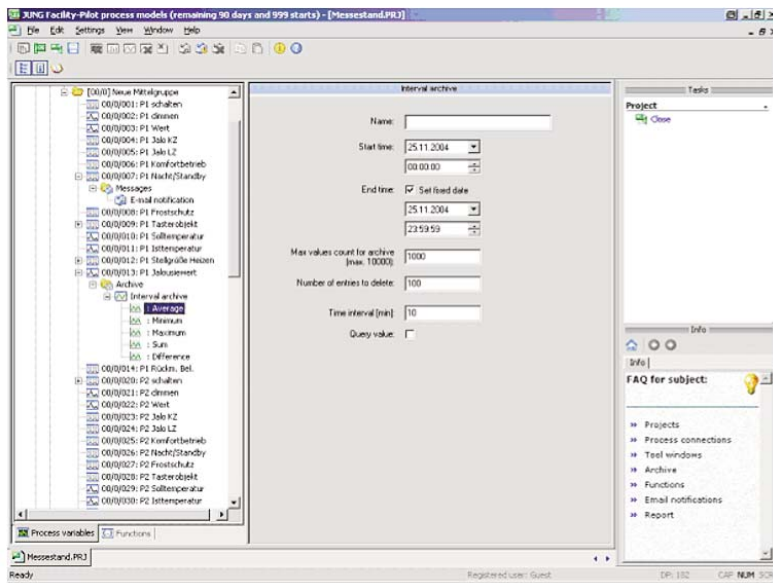

Fig. D Data processing

Values that are calculated and recorded by the process can be represented in the Visualisation Editor. Curve diagrams can also be displayed in the worksheet.

The visualisation package contains the option of viewing and testing archives directly. Values are represented in table format and graphical in a diagram.

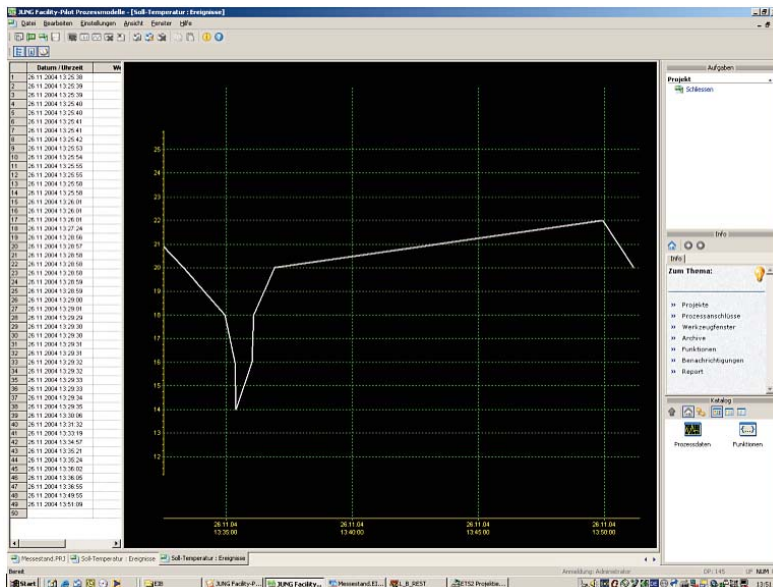

Fig. E Data recording

The functions within the process model

The available logic functions which are created in the process model are amongst others “AND”, “OR” and “XOR”. A KNX installation can be significantly enhanced through these functions. In addition to the basic functions such as ‘AND’ and ‘OR’, there is a whole range of additional functions in the system which underline its capability.

When a visualisation is logically connected, you can clearly see what effect it has (Fig. F).

The following functions are the more advanced ones to realize even very complex applications:

- **Scene:** A scene is a collection of commands. When it is started, these commands are sent on the bus in no chronological order in contrast to the sequence function.
- **Sequence:** In addition to the basic functions, there is the “Sequence” function, which could be described as a smart scene. I.e. a command is only executed when a specific condition is enabled. Specific loads are switched on at the press of a button, as defined in the process model. A presence simulation can thus easily be implemented. A time stamp can likewise be inserted which can be assigned to each switch or lighting fitting. With this function, it is possible to indicate the last time that someone operated a device or entered a room.
- **Forwarding:** This gateway function is a very important function if you have two different process connections for example. If you wish to use or display a value from the heating system (OPC) in the KNX installation, you have a source value which is routed to a target value (gateway functionality). A bridge is thus created in a simple way between the process connections.
- **Status function:** The status variable takes the last reported value and simulates KNX status objects if specific KNX devices for instance do not have these status objects at their disposal.
- **Gate function** which can be implemented with the IF/THEN function: The If / Then function is used to calculate the values of process variables depending on other process variables and conditions. E.g. it can be used to configure a priority control: The value of a switch will only be sent to an actuator, when the control of the actuator by the switch has been allowed. The allowance may depend on another binary process variable.
- **Mathematic functions:** Here any basic calculation can be used within a formula. The syntax of the formula is similar to the Excel one.
- **Time delay:** For example, we switch the light on in the toilet and the fan is activated with a time delay. No further installation is required. The user has the option of setting times as required without ETS programming.
- **Automatic guard:** If you take an area of a refrigeration plant which has to be monitored, temperatures between 3° and 5° can be defined e.g. for the cold store and values of > -8° for the deep-freeze room. The visualisation takes over the task of monitoring (watchdog function) this operating state and issues an alarm when the temperature rises above or falls below the required temperatures. Specific monitoring periods can also be selected. In the event of an alarm, this is issued acoustically but it can also be routed as an e-mail (→ SMS on a mobile phone) or via fax. Alarms are verified on a list. All alarms are displayed there as “acknowledged” and “not acknowledged”.
- **Counter:** If you wish to know for example how often the burner of the heating system cycles, its starting and stopping pulses are taken as the basis. You then count how long the burner is active for. The hours and minutes of the operating time can be displayed with the help of the counter as well as the average switching time. The counter elements can be used as upwards or downwards counter.

Summarized, you can say that the system offers a number of basic functions and is equipped moreover with higher value functions such as the counter or If / Then function which could be put together from basic functions but have already been implemented without any programming work. Further modules, which do not need to be built together from basic functions, are conceivable and planned, not as a basic function but as function modules. Frequently used functions are integrated in the visualisation as virtual devices. The process model is extended for this purpose. In general, there are no limits for these functions or basic scripts. The only limit is the configuration of the PC where the Facility Pilot is installed.

Fig. F

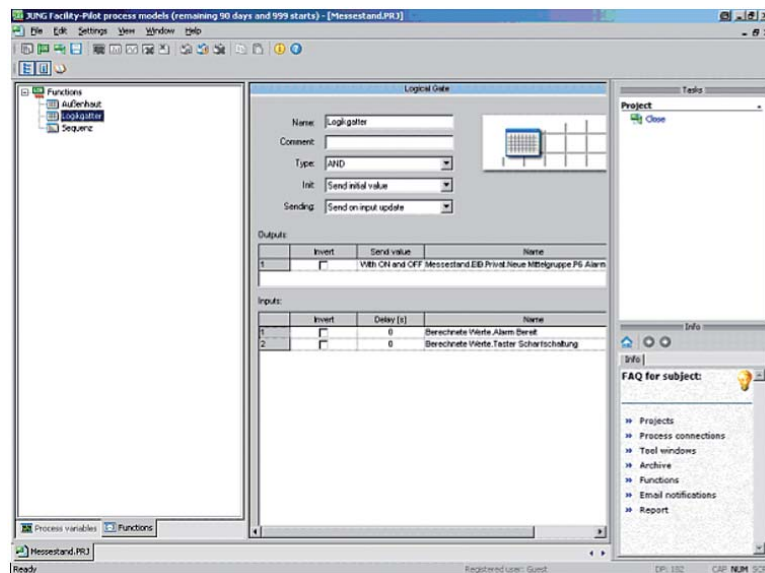

Visualisation Editor

The visualisation editor presents the whole bus system as a model on the screen. The user has virtual access to devices and can make settings which apply to the bus system. The layout of the corresponding building can be shown for clear, convenient operation, and symbols for lighting, blinds or central heating can be allocated individually from an icon library. The visualisation is based on individual work sheets which can be stored in unlimited numbers in the system. The background of the visualisation can be created with DXF, JPG, BMP, WMF or EMF formats. Thus you can offer the customer a unique visualisation which is tailor-made for his personal taste or is based on the CD/CI concept of a company.

Next to the main presentation area, the right-hand side of the screen shows a working and help section which the user can set up according to his individual needs (Fig. G).

It is very simple to work with the editor and is made even easier with functions such as undo, redo, zoom, rulers, guidelines and grid as well as several editing levels. The system is organised in three levels (planes) – the static, the dynamic and the link level, which can be shown and hidden again depending on the particular work phase. The visualisation system is rounded off by an extensive interactive help function which the user can call up at any time.

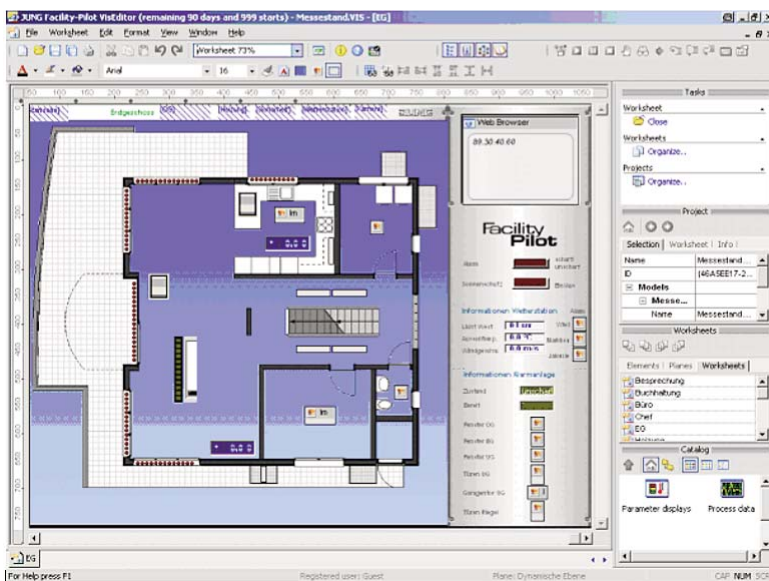

Fig. G

The visualization editor creates a report of the visualization project, the worksheets in the project, their properties and their connections to process variables. For each worksheet an image of the whole worksheet is displayed and list of the contained display elements along with their position etc.

The calendar program

The yearly calendar program is an own module for creating and configuring automatic time switch functions can be configured via drag & drop.

An unlimited number of calendars can be created.

A very user friendly **weekly timer** is implemented in the Process Model as well as in the Visualisation Editor. It can be used to generate time dependent individual scenes. The end user can change and edit scenes as well as the switching times.

The process model to which the time program should refer is selected first of all. Then various daily programs are created for example which are given corresponding commands. In contrast to classic clocks, the system does not operate channel-specifically i.e. it is not necessary to create a unique program for each channel.

In addition, to the powerful and complex yearly calendar, a weekly timer can be implemented into the visualisation project, i. e. the customer can open the timer within the player mode and change the settings. Because it is a regular display element, similar to any lamp or push-button symbol, you can you can use as much weekly timer as necessary.

Network application

The network features of the Facility Pilot software are used to connect several PC's with Facility Pilot installations over a TCP/IP – network. Each PC with the Facility Pilot software installed is called a Facility Pilot station or just "station" for short.

Visualisation players of several Facility Pilot stations can be connected with a process model within a remote Facility Pilot station.

Fig. H

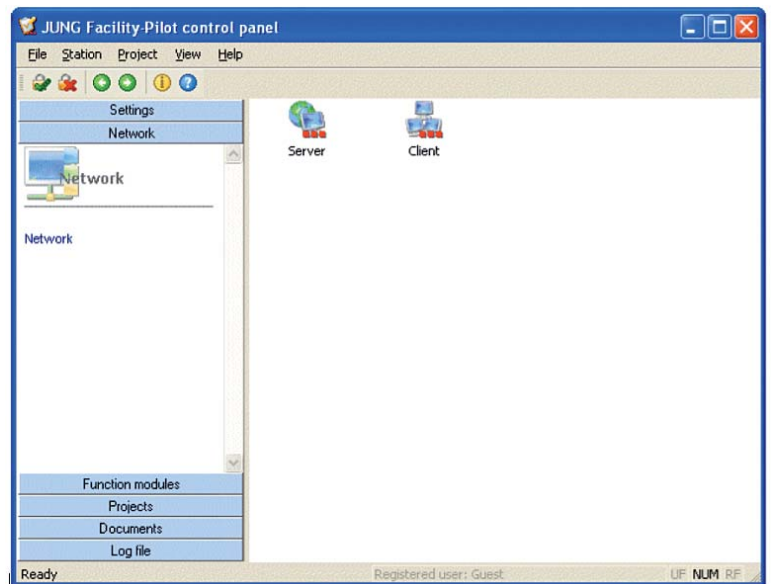

The network architecture follows a client/server-model (Fig. H), with one station as the server and the other stations as clients.

The server is connected to the technical process. Clients query process states from the server, to change process states they send commands to the server.

A typical application of this new network features is the connection of several touch panels with a server.

The network protocol is based on TCP/IP and requires authentication with a user name and a password. Multiple client stations can be connected via TCP/IP to one server station.

The maximum number of clients depends on the capabilities of the server, hardware and operating system. In some cases it may be preferable to use a WINDOWS server version.

In most cases, network traffic caused by the JUNG Facility-Pilot software will be quite low, since not much more than changes to the process states and keep-alive telegrams will be transmitted.

In particular no graphics need to be transmitted, since the visualisation project is running at the client.

XPL editor for audio applications

There is an increasing desire to combine home and building automation with streaming of digital music. For instance lighting and music control can be integrated in scenes, which can be selected at the push of a button from anywhere in the building.

One of the best systems for audio streaming over IP networks is the Squeezebox-system from the company Logitech, Inc. (Fig. H). Audio streams are transmitted over Ethernet or wireless (IEEE 802.11) networks from a server with the open-source Squeeze center software to Squeezebox music players, and in turn controlled by the Facility Pilot XPL editor.

Supported audio streams are for instance Internet Radio, MP3, WAV, WMA and Ogg Vorbis.

We strongly recommend not to install the Squeeze center software at the PC running the Facility Pilot system, since the Squeeze center could impair the proper operation of the automation system.

The XPL editor of the Facility Pilot system controls the Squeeze center and in turn the Squeezebox music players via the XPL data protocol, which is standardised by the XPL project.

Among other possibilities, using the XPL editor, push buttons and dimming functions can be used to control volume, playlists etc., or messages can be displayed at the music player's display.

For the indication of tracks or playlists KNX front end devices as FD RCD, colour touch panel, etc. can be used.

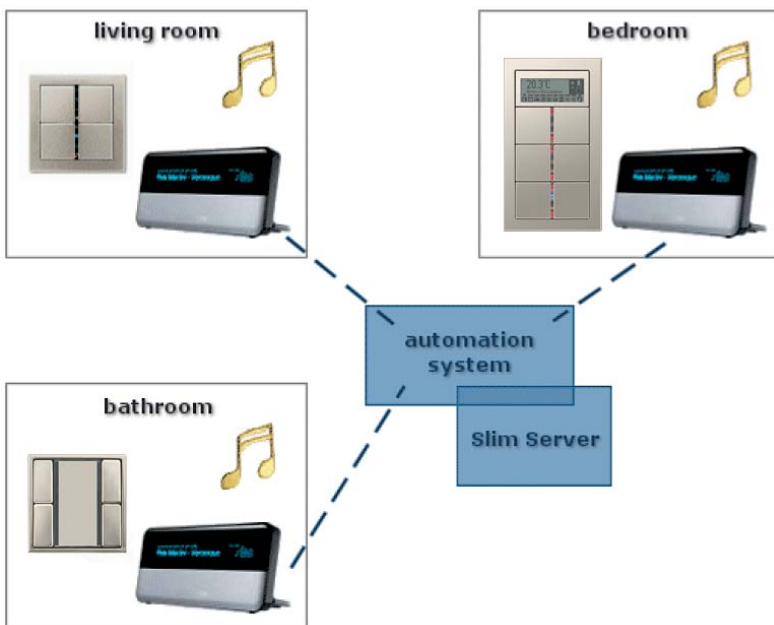

Fig. I

Device Editor –

The truly open interface to other proprietary systems

From a user's point of view, the Device Editor provides new process interfaces beside the KNX Editor or the XPL Editor, as yet in particular to a range of IP- or serial-capable devices. It is useful for the integration of multimedia applications in building and home automation systems as well as to convert e. g. an iPad into a universal remote for building management functions. The device editor provides more connectivity to other devices with custom protocols.

From a software developer's point of view, the device editor also provides an environment to extend the system with new process interfaces, as far as the data protocol can be reasonably described in a script. The device editor provides an application program interface (API) to be used in the script, and a user interface for its data, which are described in a XML file. Each process interface with XML and script files is just read from a file directory, which can be copied from one computer to another and run as a plugin in an own thread.

The process interface

The Device Editor has already an integrated process interface for UDP commands. The UDP command process interface is automatically

Fig. J

installed by the setup program. Other process interfaces for various systems are available on request.

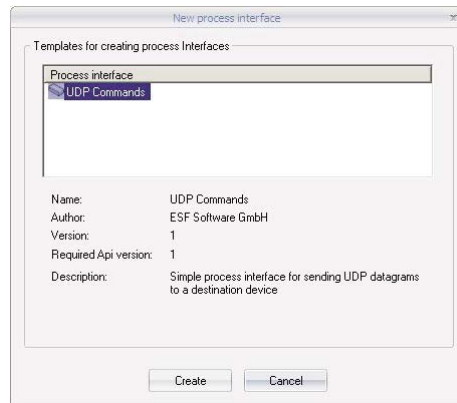

The dialog shows the available process interface types along with their properties and the version of the API (Application Programming Interface) which is expected from the Device Editor. The API version of the process interface must be compatible to the API provided by the Device Editor. It will not accept process interfaces with an API version number greater than the version number of its own API.

The actual content of a process interface is determined by a description of its possible data points and a collection of scripts for its dynamic behaviour, for example methods for data transmission and interpretation.

Here we use the process interface UDP commands as an example.

This process interface is installed by the setup program.

The UDP commands process interface allows to send internet datagrams according to the User Datagram Protocol (UDP) – standard.

This is a standard supported by many IP – capable devices.

With the UDP commands process interface, binary values, analog values and time information can be sent. These data correspond to data points, which have to be defined accordingly.

For each device, connected via UDP, its data points are grouped into one or more data point folders. There may be an additional folder for additional data, which are not transferred to the device and not described as data points. This is called the resources folder.

Note that data points are visible in the Process Model, data in the resources folder are only visible in the Device Editor project. Only by a check in the “Export” field these data are also transferred to the Process Model to be used e. g. within a forwarding function.

Finally, the folders used by a process interface are determined by the process interface itself and its usage, not by the Device Editor.

The Device Editor's role is to provide the API and a user interface for the process interface.

The UDP commands interface sample provides the following folders:

- The Resources folder: Here the UDP communication port is defined.
- Data point folder, which per default is named “Device”, since they represent commands to a physical device. Here various data point folders can be created, such as analog value, switch on/off or date/time.

Fig. K

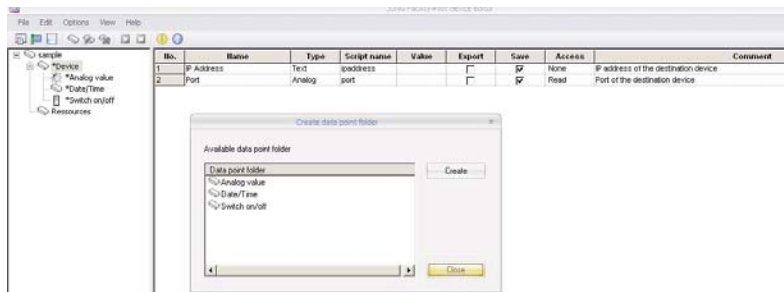

The Device Editor can handle several process interfaces in parallel. E.g. the IP commands of an iPad could be transferred to the Process Model to control KNX functions via forwarding function.

Simultaneously, the multi media equipment could be controlled by an iPad as well by using an additional serial interface within the Device Editor.

JUNG Smart Remote Application

A JUNG KNX-installation, a W-LAN network and the JUNG Visualisation software Facility Pilot (FAP) provided, you can use the iPhone / iPod Touch / iPad with the existing project for free as a universal remote control for the KNX building functions (lighting, blinds, heating/AC control). An additional remote control of multimedia components is also possible, if these components are integrated into the building automation system.

The JUNG Smart Remote sample project demonstrates how an iPhone / iPod Touch can be used to control building functions intuitively. After the upload to the Apple device it shows one horizontal and one vertical page with various buttons and displays. After pressing a button an IP-telegram will be transmitted via W-LAN. These telegrams are converted within Facility Pilot (FAP) into KNX-group addresses. Light, blinds, heating and music can be controlled with the corresponding actuators via a server where Facility Pilot is installed.

A Smart Remote Starter Kit is available on the website. This kit contains the GUI for the iPhone / iPod Touch, the project files for the Facility Pilot („TwoPagesTest.eib“ / „TwoPagesTest.prj“ and „TwoPagesTest.sdv“) as well as the Smart Remote Interface for FAP. All these items are installed automatically on your PC, the project files are imported automatically into your FAP, the interface is copied into the specific folder of the Device Editor.

For test and demonstration purposes a graphical user interface (GUI) for the iPhone / iPod Touch is available in the project folder „TwoPagesTest“.

After the upload of the GUI into your iPhone / iPod Touch you can test and demonstrate the Smart Remote application without an existing KNX system. The functions are simulated in the FAP visualisation project. In conjunction with the used KNX group addresses you can easy connect the system with a KNX system to achieve a real demonstration.

It is strongly recommended to use this starter kit to generate your individual application. You only have to modify the GUI and the data points within the FAP.

With the free of charge software „JUNG Smart-Remote-Editor“ individual control pages can be generated. You can upload these to your iPhone / iPod Touch / iPad. If you require more than one horizontal and one vertical page you need the device specific registration code (license fee). Together with the ref.-no. "App-Lizenz" we need the UDID of your Apple device which can be obtained via iTunes or via the JUNG Smart Remote Editor (described under "5." on the following).

Commissioning of the JUNG Smart Remote

1. Download the software for the GUI and the upload service „JUNG Smart-Remote-Editor“ from http://gb.jung.de/t/25_12612.html
2. Design your own GUI project or open an existing project, e.g. JUNG-Demo.gui.

3. Adjust the IP-address and the port for the Facility Pilot for the communication with the iPhone / iPod Touch / iPad in the project properties (→ Control System).

It is strongly recommended to use our sample GUI with all the available icons and symbols, just copy and paste symbols/pages.

Fig. L

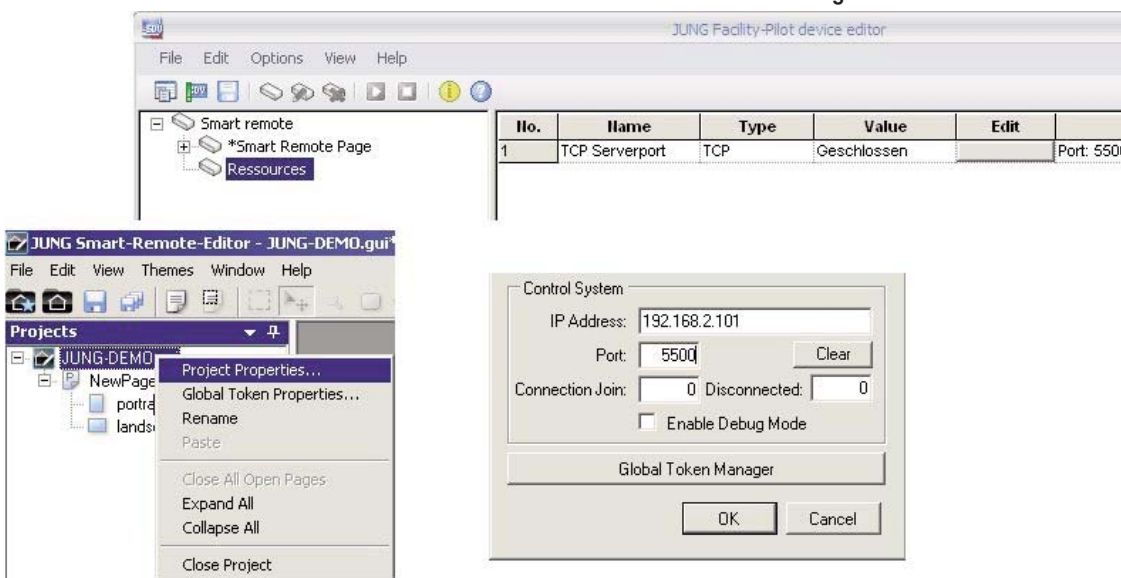

- Open the properties of the Smart Remote App at your iPhone / iPod Touch and insert the file URL, from where the program should be uploaded. (IP address of the computer on which the JUNG Smart Remote Editor is installed).
Turn the switch „Reload GUI file“ to „ON“.

Fig. M



The port for the project upload is independent of the communication port of the Facility Pilot (control system). This port is only used for the upload from the Smart-Remote-Editor onto the iPhone / iPod Touch / iPad.

- First start the Upload Service in the JUNG Smart-Remote-Editor. The string (UDID) in the window "Connected Device ID:" is used to generate a possible registration code and should be saved. This device ID you will find also in iTunes if the iPhone / iPod Touch / iPad is connected. To find it, please click on the line "serial number" on the tab "Overview". Now it will display the Identification (UDID).

Fig. N

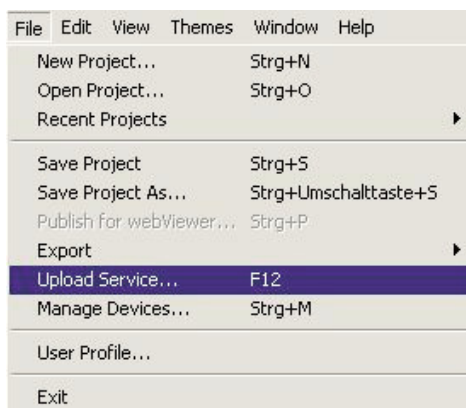

6. Second start the Smart Remote at your iPhone / iPod Touch / iPad and the project will be uploaded indicated by the flashing green ac
7. After the upload close the Smart Remote (Press the home button at your iPhone / iPod Touch iPad) and switch the „Reload GUI File“ button in the settings to „OFF“, otherwise it will try to upload a GUI again when the Smart Remote is started next time.
8. You only need a registration code (license fee) for using an interface with multiple pages. This code you request with the device-UDID per device. The registration must be added to the project (→ File → Manage devices).

Device-ID = enter device name and registration code, click “add” save the project and upload it, as described above.

For using a project with multiple devices all registrations have to be added.

The registration code of a device is valid for a random number of projects, whereas only one project could be uploaded to the relative device.



Fig. 0
Two page sample
template in the
JUNG Smart Remote
Editor

The final steps are to modify the FAP Device Editor and the Process Model. Within the Device Editor project further data points can be added according to the GUI file display elements and data points. In the Process Model the forwarding functions for your specific project have to be added or modified according to the functions you want to control via your iPhone / iPod Touch / iPad.

The final steps are to modify the FAP Device Editor and the Process Model. Within the Device Editor project further data points can be added according to the GUI file display elements and data points. In the Process Model the forwarding functions for your specific project have to be added or modified according to the functions you want to control via your iPhone / iPod Touch / iPad.

New features of FAP 3

- No update from FAP 2 to FAP 3
 - both versions can run on one PC
 - old projects still can be modified with FAP 2
- Scripting changed completely to LUA
 - scripts for FAP 2.1.3 can't be used and must be converted into LUA
- Only Windows XP and 7 are supported
 - on Smart Pilots WES 2009
 - Windows 7 design is adapted, FAP is modernised
- EIB Editor → KNX Editor → knxproj import possible with ETS 4
 - multiple selection of data points, more time effective
 - support of free address structure of ETS 4
- Important Data folder now in
 - C:\Documents and settings\All Users\Documents\Facility-Pilot3
- Smart consumption archive within the process model
 - different time periods selectable: daily / weekly / monthly / yearly
 - different displays: single value / additive value / percental value

FAP 3: new Visualisation Editor

- Complete new Visualisation Editor, existing FAP controls, plus:
- New JUNG controls beside existing control elements and panels:
 - standardised JUNG GUI throughout the whole JUNG KNX project
 - more intuitive control of the visualisation

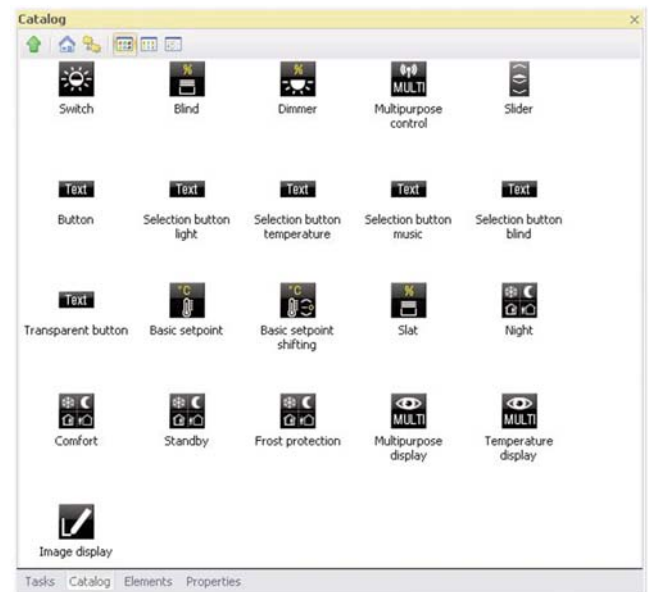

- Panels (containers):
 - Border panel
 - Main panel („carousel“)
 - Stack panel
 - Tab panel

- Panels are used as masks (frames), controls are placed into these masks
 - function / room selection



Borderpanel



Main Panel

- Stack panels available as horizontal or vertical version with various elements.

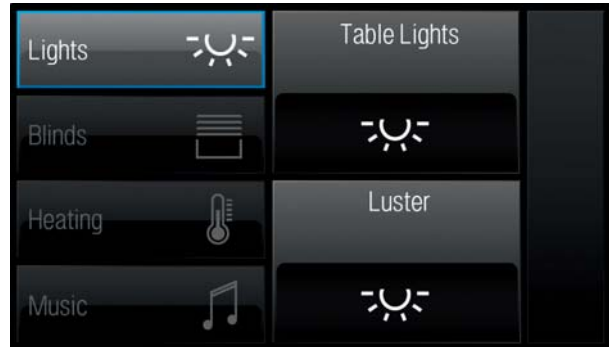

- Tab panels consist out of various ports (tabs) to switch-over various controls. The following sample has 4 ports (lighting, blind, temperature, music)
 - Each tab is filled with stack panels with various controls.



- Selection of templates available
- User can organise own work templates for different design phases
 - fast configuration of a customised page/project

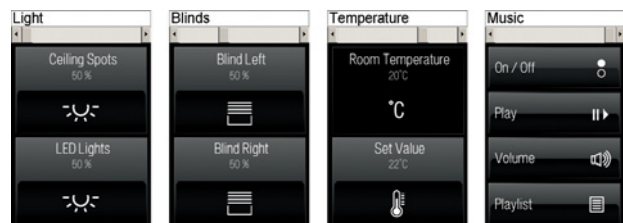

The intuitive GUI of the JUNG control displays

The intelligent building technology KNX has an increasing versatile functionality. In addition to the control of established room functions, aspects as Smart Metering and Multimedia gain more importance. For the optimum use of the functional variety, JUNG developed a standardised graphical user interface (GUI) which enables an intuitive operation.

All JUNG Smart Displays are equipped with this new GUI. It is logical structured by function, rooms and favourites. The layout is uniformly designed and the operating philosophy can easily achieved with all JUNG display devices.

Furthermore, the uniform GUI can be implemented into mobile control systems. In the iTunes Store you can download the App „Smart Remote“ for iPhone, iPad or iPod touch to realise a remote controlled KNX system.



The JUNG GUI enables the intuitive control of all Smart Displays with the same operating philosophy.

JUNG



Ref.-no.	Page	Ref.-no.	Page	Ref.-no.	Page	Ref.-no.	Page
CD 2094 LZ GR	22	CD 404 TSAP 23	29, 37	FDAL 2902 TSA AN	42	LS 2092 NABS LG	17
CD 2094 LZ LG	22	CD 404 TSAP GR 14	29, 37	FDAL 2902 TSAP	42	LS 2092 NABS SW	17
CD 2094 LZ SW	22	CD 404 TSAP GR 23	29, 37	FDAL 2902 TSAP AN	42	LS 2092 NABS WW	17
CD 2094 LZ WW	22	CD 404 TSAP LG 14	29, 37	FDAL 2904 TSA	42	LS 2094 F	20
CD 2094 NABS GR	18	CD 404 TSAP LG 23	29, 37	FDAL 2904 TSA AN	42	LS 2094 F LG	20
CD 2094 NABS LG	18	CD 404 TSAP SW 14	29, 37	FDAL 2904 TSAP	42	LS 2094 F SW	20
CD 2094 NABS SW	18	CD 404 TSAP SW 23	29, 37	FDAL 2904 TSAP AN	42	LS 2094 F WW	20
CD 2094 NABS WW	18	CD 404 TSAP WW 14	29, 37	FDES 2902 TSA	42	LS 2094 LZ	22
CD 2178 GR	62	CD 404 TSAP WW 23	29, 37	FDES 2902 TSAP	42	LS 2094 LZ LG	22
CD 2178 LG	62	CD 4093 TSA	37	FDES 2904 TSA	42	LS 2094 LZ SW	22
CD 2178 ORTS GR	65	CD 4093 TSA GR	37	FDES 2904 TSAP	42	LS 2094 LZ WW	22
CD 2178 ORTS LG	65	CD 4093 TSA LG	37	FF 7.8	64	LS 2094 NABS	18
CD 2178 ORTS SW	65	CD 4093 TSA SW	37	FP 701 CT IP	147	LS 2094 NABS GGO	18
CD 2178 ORTS WW	65	CD 4093 TSA WW	37	FP AL 781	147	LS 2094 NABS LG	18
CD 2178 SW	62	CO2 ... 2178 ..	67	FP ES 781	147	LS 2094 NABS SW	18
CD 2178 TS GR	63	D SNT 105	119	FP GLAS 781	147	LS 2094 NABS WW	18
CD 2178 TS LG	63	DAS 4110	140	FP GLAS 781 EX	147	LS 2178	62
CD 2178 TS SW	63	DAS 4120	140	FPI 781 AN	147	LS 2178 LG	62
CD 2178 TS WW	63	DAS 4210	141	FUS 4410 BR	141	LS 2178 ORTS	65
CD 2178 WW	62	DAS 4300 A	141	FUS 4410 WW	141	LS 2178 ORTS LG	65
CD 3180 GR	52	DAS 4300 U	141	FUS 4415 WW	141	LS 2178 ORTS SW	65
CD 3180 LG	52	DAS 4360	141	FUS 4620	140	LS 2178 ORTS WW	65
CD 3180 SW	52	DAS 4610	140	GCR 2071 NABS	12	LS 2178 SW	62
CD 3180 WW	52	EAM 4000	138	GCR 2072 NABS	13	LS 2178 TS	63
CD 3180-1 A GR	54	EBG 24	146, 148	GCR 2074 NABS	14	LS 2178 TS LG	63
CD 3180-1 A LG	54	ES 2071 NABS	12	GCR 2091 NABS	16	LS 2178 TS SW	63
CD 3180-1 A SW	54	ES 2072 NABS	13	GCR 2092 NABS	17	LS 2178 TS WW	63
CD 3180-1 A WW	54	ES 2074 NABS	14	GCR 2094 LZ	22	LS 2178 WW	62
CD 3280 GR	52	ES 2091 NABS	16	GCR 2094 NABS	18	LS 3180	52
CD 3280 LG	52	ES 2092 NABS	17	GCR 2178	62	LS 3180 LG	52
CD 3280 SW	52	ES 2094 F	20	GCR 2178 ORTS	65	LS 3180 SW	52
CD 3280 WW	52	ES 2094 LZ	22	GCR 2178 TS	63	LS 3180 WW	52
CD 3280-1 A GR	54	ES 2094 NABS	18	GCR 3180	52	LS 3180-1 A	54
CD 3280-1 A LG	54	ES 2178	62	GCR 3180-1 A	54	LS 3180-1 A LG	54
CD 3280-1 A SW	54	ES 2178 ORTS	65	GCR 3280	53	LS 3180-1 A SW	54
CD 3280-1 A WW	54	ES 2178 TS	63	GCR 3280-1 A	54	LS 3180-1 A WW	54
CD 4 AR	29, 37	ES 2401 TSA	30	GO 2071 NABS	12	LS 3280	53
CD 401 TSA	28	ES 2401 TSAP	31	GO 2072 NABS	13	LS 3280 LG	53
CD 401 TSA GR	28	ES 2402 TSA	30	GO 2074 NABS	14	LS 3280 SW	53
CD 401 TSA LG	28	ES 2402 TSAP	31	GO 2091 NABS	16	LS 3280 WW	53
CD 401 TSA SW	28	ES 2403 TSA	30	GO 2092 NABS	17	LS 3280-1 A	54
CD 401 TSA WW	28	ES 2404 TSA	30	GO 2094 F	20	LS 3280-1 A LG	54
CD 401 TSAP	29	ES 2404 TSAP 14	31, 38	GO 2094 LZ	22	LS 3280-1 A SW	54
CD 401 TSAP GR	29	ES 2404 TSAP 23	31, 38	GO 2094 NABS	18	LS 3280-1 A WW	54
CD 401 TSAP LG	29	ES 3180	52	GO 3180-1 A	54	LS 4 AR	31, 38
CD 401 TSAP SW	29	ES 3180-1 A	54	IPR 100 REG	95	LS 401 TSA	30
CD 401 TSAP WW	29	ES 3280	53	IPS 100 REG	94	LS 401 TSA LG	30
CD 402 TSA	28	ES 3280-1 A	54	KSB 4	89	LS 401 TSA SW	30
CD 402 TSA GR	28	ES 4093 TSA	38	KSE 2	89	LS 401 TSA WW	30
CD 402 TSA LG	28	FAP-300-3-GB	150	LS 2071 NABS	12	LS 401 TSAP	31
CD 402 TSA SW	28	FAP-50-3-GB	150	LS 2071 NABS LG	12	LS 401 TSAP LG	31
CD 402 TSA WW	28	FAP-CL-3-GB	150	LS 2071 NABS SW	12	LS 401 TSAP SW	31
CD 402 TSAP	29	FAP-FULL-3-GB	150	LS 2071 NABS WW	12	LS 401 TSAP WW	31
CD 402 TSAP GR	29	FAP-PL-3-GB	150	LS 2072 NABS	13	LS 402 TSA	30
CD 402 TSAP LG	29	FCA 2 REGHE	122	LS 2072 NABS LG	13	LS 402 TSA LG	30
CD 402 TSAP SW	29	FD 902 TSA	42	LS 2072 NABS SW	13	LS 402 TSA SW	30
CD 402 TSAP WW	29	FD 902 TSA LG	42	LS 2072 NABS WW	13	LS 402 TSA WW	30
CD 403 TSA	28	FD 902 TSA WW	42	LS 2074 NABS	14	LS 402 TSAP	31
CD 403 TSA GR	28	FD 902 TSAP	42	LS 2074 NABS LG	14	LS 402 TSAP LG	31
CD 403 TSA LG	28	FD 902 TSAP LG	42	LS 2074 NABS SW	14	LS 402 TSAP SW	31
CD 403 TSA SW	28	FD 902 TSAP WW	42	LS 2074 NABS WW	14	LS 402 TSAP WW	31
CD 403 TSA WW	28	FD 904 TSA	42	LS 2091 NABS	16	LS 403 TSA	30
CD 404 TSA	28	FD 904 TSA LG	42	LS 2091 NABS GGO	16	LS 403 TSA LG	30
CD 404 TSA GR	28	FD 904 TSA WW	42	LS 2091 NABS LG	16	LS 403 TSA SW	30
CD 404 TSA LG	28	FD 904 TSAP	42	LS 2091 NABS SW	16	LS 403 TSA WW	30
CD 404 TSA SW	28	FD 904 TSAP LG	42	LS 2091 NABS WW	16	LS 404 TSA	30
CD 404 TSA WW	28	FD 904 TSAP WW	42	LS 2092 NABS	17	LS 404 TSA LG	30
CD 404 TSAP 14	29, 37	FDAL 2902 TSA	42	LS 2092 NABS GGO	17	LS 404 TSA SW	30

Index

Ref.-no.	Page	Ref.-no.	Page	Ref.-no.	Page	Ref.-no.	Page
LS 404 TSA WW	30	RCD AL 3094 M AN	40				
LS 404 TSAP 14	31, 38	RCD AL 3096 M	40				
LS 404 TSAP 23	31, 38	RCD AL 3096 M AN	40				
LS 404 TSAP LG 14	31, 38	RCD ES 20 NA	44				
LS 404 TSAP LG 23	31, 38	RCD ES 2021	43				
LS 404 TSAP SW 14	31, 38	RCD ES 2022	43				
LS 404 TSAP SW 23	31, 38	RCD ES 2023	43				
LS 404 TSAP WW 14	31, 38	RCD ES 2024	44				
LS 404 TSAP WW 23	31, 38	RCD ES 2044	44				
LS 4093 TSA	38	RCD ES 3094 M	40				
LS 4093 TSA LG	38	RCD ES 3096 M	40				
LS 4093 TSA SW	38	RSP 10 SW D	145				
LS 4093 TSA WW	38	RSP 10 WW D	145				
MBT 2424	149	RSP 15 SW D	145				
MM 100	77	RSP 15 WW D	145				
MT 701	148	RSP 19 SW D	145				
MW 270 AL	77	RSP 19 WW D	145				
MW 270 WW	77	SP 10 EBGD	145				
PM-KAPPE	59	SP 10 FAPVD-GB	144				
R 24 AL	148	SP 10 TBKD	145				
R 24 ES	148	SP 15 EBGD	145				
R 24 SW	148	SP 15 FAPVD-GB	144				
R 24 WW	148	SP 15 TBKD	145				
R 9 AL E	146	SP 19 EBGD	145				
R 9 ES E	146	SP 19 FAPVD-GB	144				
R 9 GL E	146	SP 19 TBKD	145				
RA 23024 REGHE	124	SP 9 FAPVE-GB	146				
RCD 20 NA	44	USV 640 MA	88				
RCD 20 NA LG	44	WS 10 D	85				
RCD 20 NA WW	44	WS 10 H	85				
RCD 2021	43	WS 10 KS	82				
RCD 2021 LG	43	WS 10 KSDCF	82				
RCD 2021 SW	43	WS 10 R	84				
RCD 2021 WW	43	WS 10 T	85				
RCD 2022	43	WS 10 W	83				
RCD 2022 LG	43	WSSV 10	82				
RCD 2022 SW	43						
RCD 2022 WW	43						
RCD 2023	43						
RCD 2023 LG	43						
RCD 2023 SW	43						
RCD 2023 WW	43						
RCD 2024	44						
RCD 2024 LG	44						
RCD 2024 SW	44						
RCD 2024 WW	44						
RCD 2044	44						
RCD 2044 LG	44						
RCD 2044 SW	44						
RCD 2044 WW	44						
RCD 3094 M	40						
RCD 3094 M LG	40						
RCD 3094 M WW	40						
RCD 3096 M	40						
RCD 3096 M LG	40						
RCD 3096 M WW	40						
RCD AL 20 NA	44						
RCD AL 2021	43						
RCD AL 2021 AN	43						
RCD AL 2022	43						
RCD AL 2022 AN	43						
RCD AL 2023	43						
RCD AL 2023 AN	43						
RCD AL 2024	44						
RCD AL 2024 AN	44						
RCD AL 2044	44						
RCD AL 2044 AN	44						
RCD AL 3094 M	40						

JUNG

B-GB-KNX 0611



Certified proof of origine
„Made in Germany“
by TÜV NORD.

ALBRECHT JUNG GMBH & CO. KG
Volmestraße 1
D-58579 Schalksmühle
Germany

Phone: +49 2355 806-553
Fax +49 2355 806-306
E-mail: mail.vka@jung.de
Internet: www.jung.de

Member of

